



GUANGZHOU SANJING ELECTRIC CO.,LTD



Tel.: (86)20 66608588 Fax.: (86)20 66608589 Web: www.saj-electric.com
Add: SAJ Innovation Park, No.9, Lizhishan Road, Science City, Guangzhou High-tech Zone, Guangdong, P.R.China

V0.3



M2 Series

MICRO-INVERTER USER MANUAL

M2-1.8K-S4 | M2-2K-S4 | M2-2.2K-S4 | M2-2.25K-S4

Preface

Thank you for choosing SAJ inverter. We are pleased to provide you first-class products and exceptional service.

This manual includes information for installation, operation, maintenance, trouble shooting and safety. Please follow the instructions of this manual so that we can ensure delivery of our professional guidance and wholehearted service.

Customer-orientation is our forever commitment. We hope this document proves to be of great assistance in your journey for a cleaner, greener world.

Please check for the latest version at www.saj-electric.com

Guangzhou Sanjing Electric Co., Ltd.



TABLE OF CONTENTS

Chapter 1 Safety Instructions	1
1.1 Scope of Application	2
1.2 Safety Instructions	2
1.3 Target Group	2
1.4 Instructions Description	3
1.5 Explanations of Symbols	4
Chapter 2 Product Introduction	5
2.1 Specification for Product Model	6
2.2 Overview of Product	7
2.2 Terminals Description	7
2.3 Datasheet	8
Chapter 3 Installation Instruction.....	11
3.1 Safety Instructions	12
3.2 Pre-installation Check.....	12
3.2.1 Check the Package	12
3.2.2 Scope of Delivery	13
3.3 Determining the installation method and position	14
3.4 Mounting Procedure.....	14
3.4.1 Installation Tools.....	15
3.4.2 Mounting Procedures	16
Chapter 4 Electrical Connection	17
4.1 Safety Instruction	18
4.2 Specifications for Electrical Interface.....	18
4.3 AC Side Cable Connection	20
4.4 DC Side Cable Connection	25
4.5 PV Module Connection	26
Chapter 5 Commissioning	27
5.1 Start Up and Shut Down the Micro-inverter	28
5.1.1 Start Up	28
5.1.2 Shut Down	28
5.1.3 Introduction of the LED Indicator	28
5.2 APP Connection	28
5.2.1 Downloading the APP	28
5.2.2 Logging in to the APP	29
5.2.3 Completing the Initialization Settings.....	30
5.2.3 Bluetooth Connection	31
5.2.3 Plant Creation	33
Chapter 6 Fault Code and Troubleshooting	35
Chapter 7 Recycling and Disposal	39
Contact SAJ	40

1.1 Scope of Application

This User Manual describes instructions and detailed procedures for installing, operating, maintaining, and troubleshooting of the following SAJ products:

M2-1.8K-S4; M2-2K-S4; M2-2.2K-S4; M2-2.25K-S4;

1.2 Safety Instructions



DANGER

· DANGER indicates a hazardous situation which, if not avoided, will result in death or serious injury.



WARNING

· WARNING indicates a hazardous situation which, if not avoided, can result in death or serious injury or moderate injury.



CAUTION

· CAUTION indicates a hazardous condition which, if not avoided, can result in minor or moderate injury.



NOTICE

· NOTICE indicates a situation that can result in potential damage, if not avoided.

1.3 Target Group

Only qualified electricians who have read and fully understood all safety regulations contained in this manual can install, maintain and repair the device. Operators must be aware of the high-voltage device.





1.

SAFETY INSTRUCTIONS









1.4 Instructions Description

For safety, be sure to read all the safety instructions carefully prior to any works, and please observe the appropriate rules and regulations of the country or region where you installed all-in-one energy storage system.

 DANGER
<ul style="list-style-type: none"> · There is possibility of dying due to electrical shock and high voltage. · Do not touch the operating component of the inverter; it might result in burning or death. · To prevent risk of electric shock during installation and maintenance, please make sure that all AC and DC terminals are plugged out. · Do not touch the surface of the equipment while the housing is wet, otherwise, it might cause electrical shock. · Do not stay close to the equipment while there are severe weather conditions including storm, lightning, etc. · Before opening the housing, the SAJ inverter must be disconnected from the grid and PV generator; you must wait for at least five minutes to let the energy storage capacitors completely discharged after disconnecting from power source. · Please keep the power off prior to any operations · Do not expose the battery to temperatures in excess of 50°C. · Do not subject the battery to any strong force. · Keep inflammable and explosive dangerous items or flames away from the battery. · Do not soak the battery in water or expose it to moisture or liquids. · Do not use the battery in areas where the ammonia content of the air exceeds 20 ppm.
 WARNING
<ul style="list-style-type: none"> · Only qualified personnel who have full knowledge of local safety regulations and local standards on batteries can install, maintain, retrieve, and process this product. · SAJ Electric shall not be liable for any loss or warranty claims arising from any unauthorized change of product which may cause fatal injury to the operator, third party, or equipment performance. · For personal and property safety, do not short-circuit the positive (+) and negative (-) electrode terminals.
 CAUTION
<ul style="list-style-type: none"> · Risk of damage due to improper modification · Use professional tools when operating the products. · The inverter will become hot during operation. Please do not touch the heat sink or peripheral surface during or shortly after the operation.
 NOTICE
<ul style="list-style-type: none"> · During the installation of the battery, the circuit breaker must be disconnected from the battery pack wiring.

1.5 Explanations of Symbols

Symbol	Description
	Dangerous electrical voltage This device is directly connected to the public grid, thus all work to the battery shall only be carried out by qualified personnel.
	Danger to life due to high electrical voltage! There might be residual currents in the inverter because of the large capacitors. Wait for 5 minutes before you remove the front lid.
	Danger of hot surface The components inside the battery will release a lot of heat during operation. Do not touch metal plate housing during operation.
	An error has occurred Please go to Chapter "Troubleshooting" to remedy the error.
	This device shall NOT be disposed of in residential waste.
	CE Mark Equipment with the CE mark fulfills the requirements of the Low Voltage Directive and Electro-Magnetic Compatibility.
RoHS	This device complies with the RoHS Directive.

M2 Series

The M2-(1.8K-2.25K)-S4 micro-inverter is used in grid-tied applications, comprised of two key elements:

- M2-(1.8K-2.25K)-S4 Micro-inverter.
- Monitoring and analysis system.

The micro-inverter converts the DC electricity generated by solar panels into AC electricity which is in accordance with the requirements of the public grid and sends the AC into the grid, reducing the load pressure of the grid.

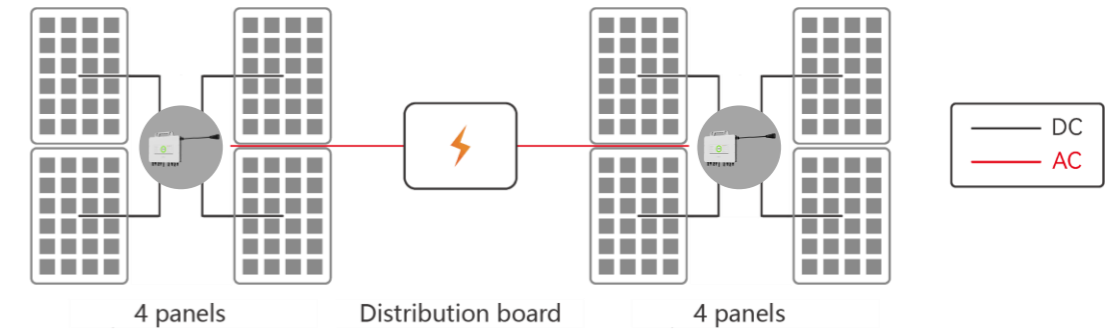

Figure 2.1
System overview

2.1 Specification for Product Model

$\frac{M2}{①}$ - $\frac{XK}{②}$ - $\frac{S4}{③}$

① M2 represents for product name.

② XK represents rated power XkW of inverter, for example, 2.25K means 2.25kW.

③ S means single phase; 4 represents the inverter has the function of 4 MPP trackers.

2.

PRODUCT INFORMATION



2.2 Overview of Product

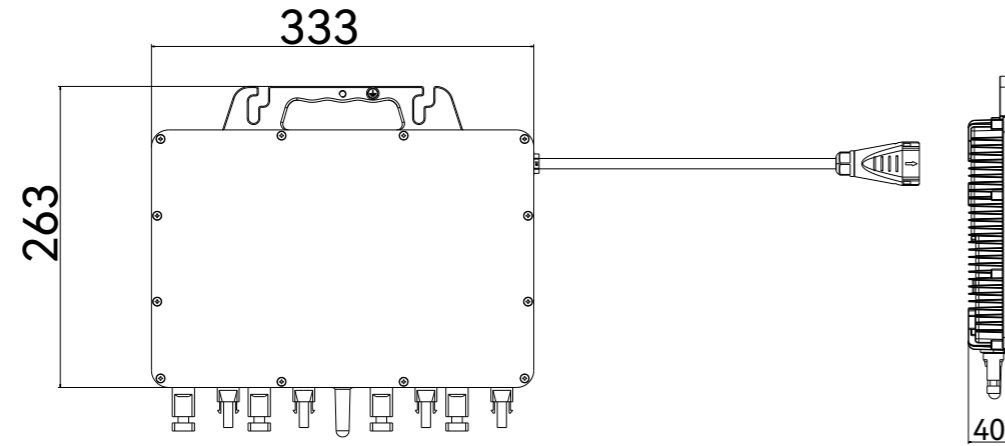

Figure 2.2
Dimensions of M2 microinverter

2.3 Terminals Description

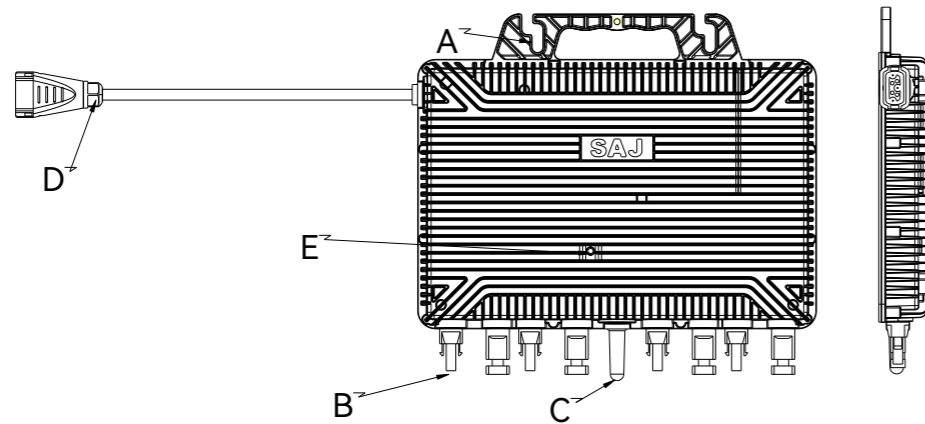

Figure 2.3
M2 microinverter interface
(rear view)

Table 2.1
M2 microinverter
Interface description

Code	Name
A	Mounting Hole
B	DC Cables
C	Antenna
D	AC Cables
E	LED Indicators

2.4 Datasheet

Model	M2-1.8K-S4	M2-2K-S4	M2-2.2K-S4	M2-2.25K-S4
Input Data (DC)				
Recommended PV Module Power (STC) Range [Wp]	400~700+			
Peak Power Tracking Voltage [V]	35~50			
Operating Voltage Range [V]	16~55			
Maximum Input Voltage [V]	60			
Maximum Input Current [A]	20 x 4			
Back-Feed Current [A]	0			
Overvoltage Category	II			
Output Data (AC)				
Maximum Output Power [VA]	1800	2000	2200	2250
Nominal Output Current [A]	7.82	8.7	9.56	9.78
Rated AC Voltage/Range [V]	L+N+PE, 220, 230, 240/180 ~ 280			
Rated Output Frequency/Range [Hz]	50, 60/45 ~ 55, 55 ~ 65			
Power Factor [cos φ]	> 0.99 default 0.8 leading ~ 0.8 lagging			

Overvoltage Category	III			
Total Harmonic Distortion [THDi]	<3%			
Maximum Units per 10AWG Branch	4	3	3	3
Efficiency				
Peak Efficiency	97.00%			
CEC Efficiency	96.00%			
Mechanical Data				
Operating Temperature Range	-40°C to +60°C (45°C to 60°C with derating)			
Communication	Wi-Fi / Bluetooth			
Cooling Method	Natural Convection			
Ambient Humidity	0-100% non-condensing			
Altitude	2000m			
Noise [dBA]	< 20			
Ingress Protection	IP67			
Dimensions (W x H x D) [mm]	333*225*40			
Weight [kg]	5.8kg			
Warranty	12 Years			
Applicable Standard	EN62109-1/2, EN61000-6-1/2/3/4, EN50438, EN50549, C10/11, IEC62116, IEC61727, RD1699, CEI 0-16, CEI O-021, AS4777.2, NBR16149, NBR 16150 VDE-AR-N 4105, VDE 0126-1-1, RoHS			

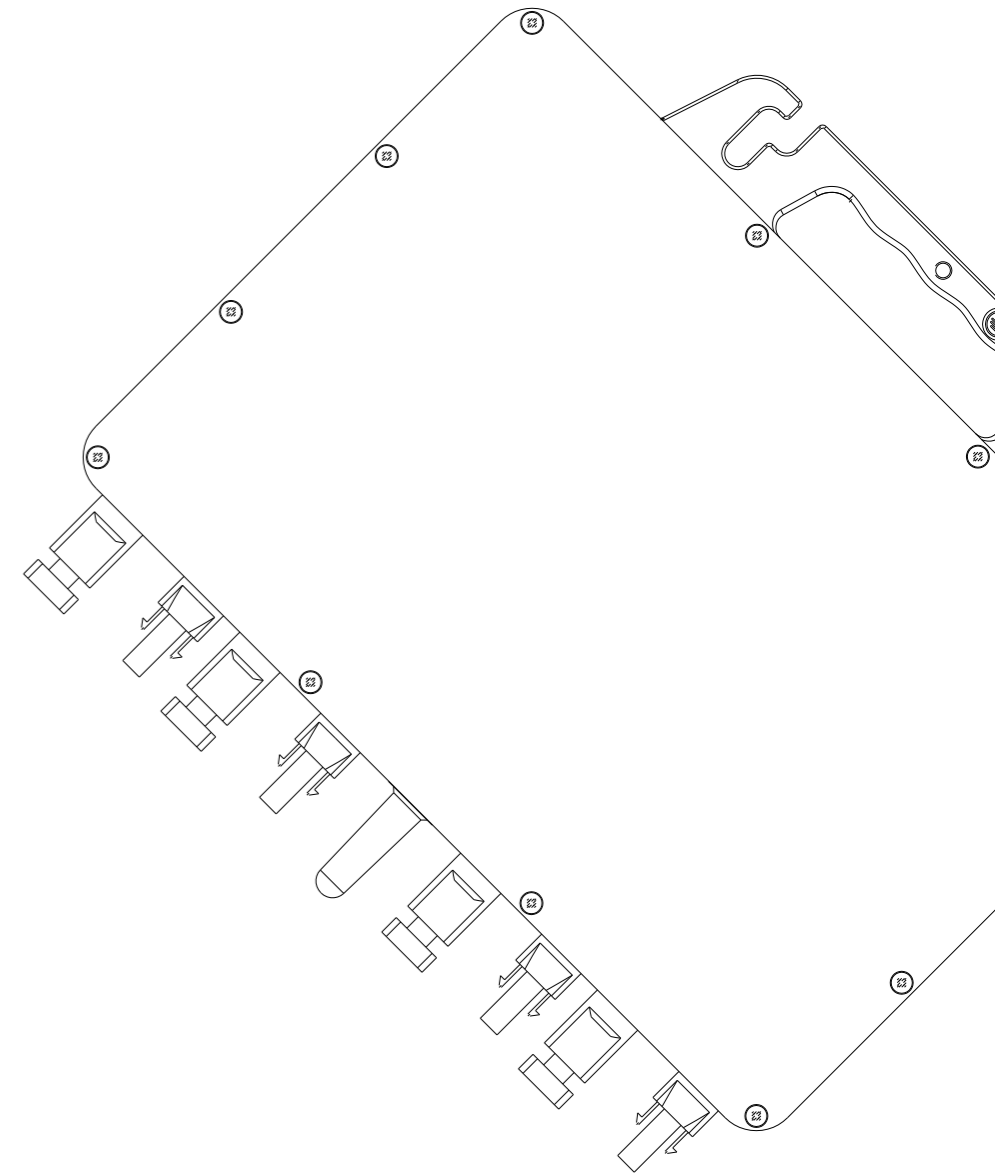

3.

INSTALLATION
INSTRUCTION

3.1 Safety Instructions

 **DANGER**

- Dangerous to life due to potential fire or electricity shock.
- Do not install the inverter near any inflammable or explosive items.
- This inverter will be directly connected with HIGH VOLTAGE power generation device; the installation must be performed by qualified personnel only in compliance with national and local standards and regulations.

 **NOTICE**

- This equipment meets the pollution degree II.
- Inappropriate installation environment may jeopardize the life span of the inverter.
- Installation directly exposed under intensive sunlight is not recommended.
- The installation site must be well ventilated.

3.2 Pre-installation Check

3.2.1 Check the package

Although SAJ's inverters have thoroughly tested and checked before delivery, it is uncertain that the inverters may suffer damages during transportation. Please check the package for any obvious signs of damage, and if such evidence is present, do not open the package and contact your dealer as soon as possible

3.2.2 Scope of Delivery

Please contact after sales if there is missing or damaged components

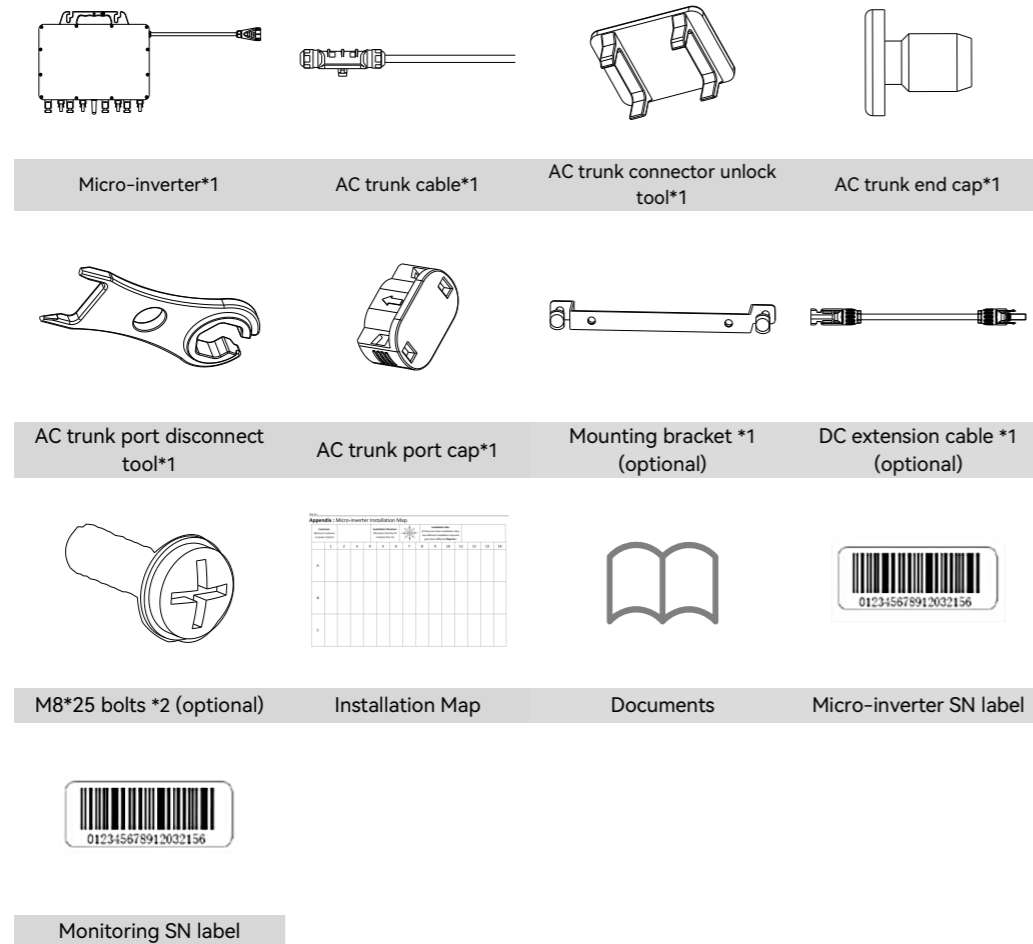

The documents include the user manual, quick installation guide and packaging list.

3.3 Determining the installation method and position

- (1) The equipment employs natural convection cooling, and it can be installed indoor or outdoor.
- (2) Mount the equipment horizontally on the rail or vertically on the mounting bracket and face the cover toward the solar panels.
- (3) Please hold the handle of the microinverter with your hands. Do not lift the AC cable with bare hands.

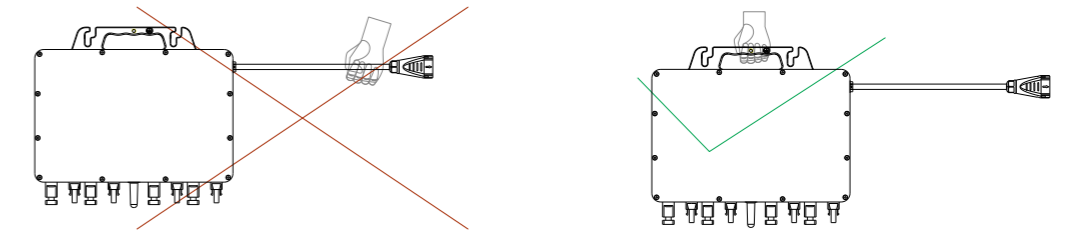

Figure 3.1
Holding method

- (4) when mounting the inverter, please consider the solidity of the wall or the rail, including accessories. Make sure the wall or the rail has enough strength to hold the screws and bear the weight of products. Please ensure the mounting bracket is mounted tightly.

Installation Environment Requirements

- The installation environment must be free of inflammable or explosive materials.
- Install the device away from heat source.
- Do not install the device at a place where the temperature changes extremely.
- Keep the device away from children.
- Do not install the device at daily working or living areas, including but not limited to the following areas: bedroom, lounge, living room, study, toilet, bathroom, theater, and attic.
- When installing the device at the garage, please keep it away from driveway.
- Keep the device from water sources such as taps, sewer pipes and sprinklers to prevent water seepage.
- The product is to be installed in a high traffic area where the fault is likely to be seen.

Note: When installing outdoors, the height of the device from the ground should be considered to prevent the device from soaking in water. The specific height is determined by the site environment.

3.4 Mounting Procedure

After Installation, you are suggested to tick in the right box (☐) on the system label according to the number of battery modules.

3.4.1 Installation Tools

Installation tools include but are not limited to the following recommended ones. Please use other auxiliary tools on site if necessary.

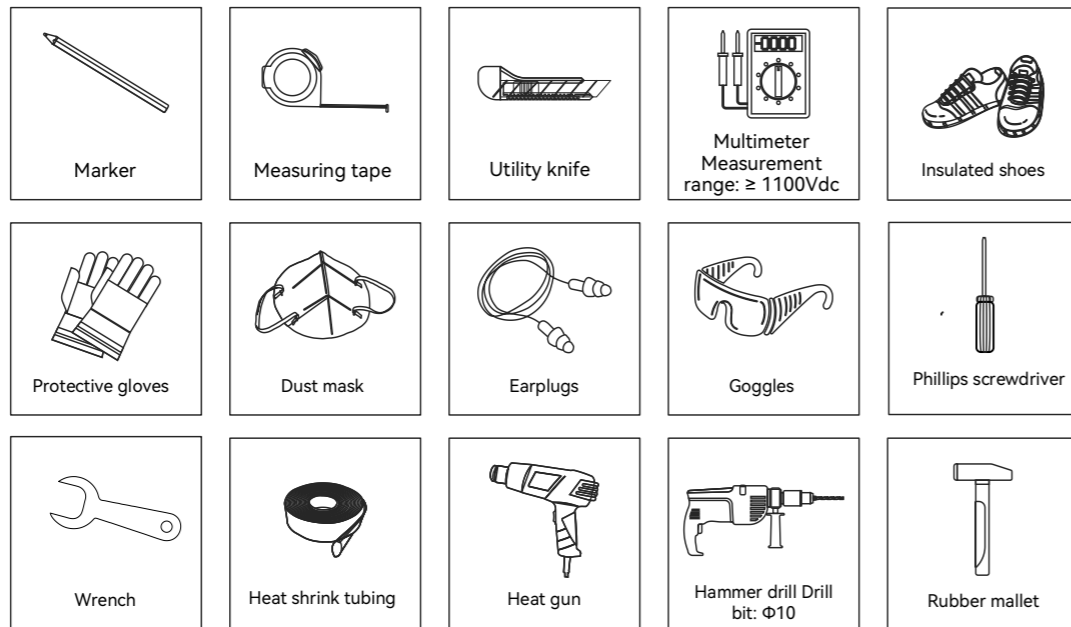

3.4.2 Mounting Procedures

Step 1: Plan and install the microinverter

Mark the position of each microinverter on the rail. Secure the screws on the marks to the rail. Face the cover toward the photovoltaic module. Hang the microinverter on the screws and tighten the screws.

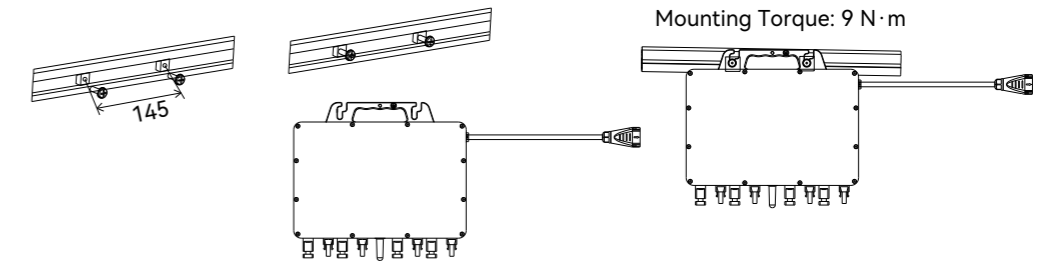

Figure 3.2
Micro-inverter installation

Note: If external grounding is required, use a grounding screw (M6) to install it to the grounding hole on the microinverter handle.

4.

ELECTRICAL
CONNECTION

4.1 Safety Instruction

Electrical connection must only be carried out by professional technicians. Before connection, necessary protective equipment must be employed by technicians including insulating gloves, insulating shoes and safety helmet.

 **DANGER**

- Dangerous to life due to potential fire or electricity shock.
- The wiring and connection of the inverter should be carried out by qualified technicians in accordance with local and national electrical standards and regulations.

 **WARNING**

- When the photovoltaic array is exposed to light, it supplies a DC voltage to the inverter.
- Ensure that all AC cables are correctly wired and that none of the wires are pinched or damaged.

 **NOTICE**

- Electrical connection should in conformity with proper stipulations, such as stipulations for cross-sectional area of conductors, fuses and ground protection.
- Use AWG 10 (4 mm²) cable for AC trunk cable.

4.2 Specifications for Electrical Interface

Note: Except for optional parts and parts provided by installers, all other accessories are included in the product package.

No.	Part Name	No.	Part Name
A	AC trunk cable	E	Mounting bracket (optional)
B	AC trunk connector unlock tool	F	AC trunk port cap
C	AC trunk end cap	G	AC trunk port disconnect tool
D	M8*25 bolts (optional)	I	DC extension cable (optional)

Table 4.1
Installation parts

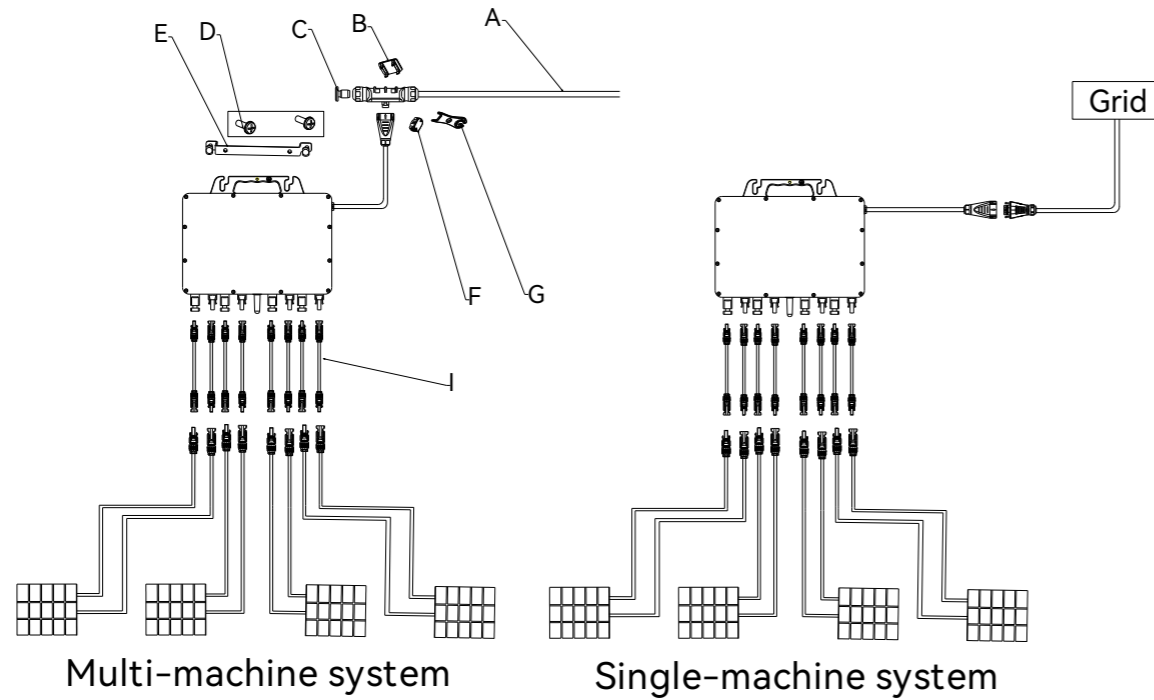

Figure 4.1
Connection diagram

4.3 AC Side Cable Connection

Step1: Take out the AC connector from the package.

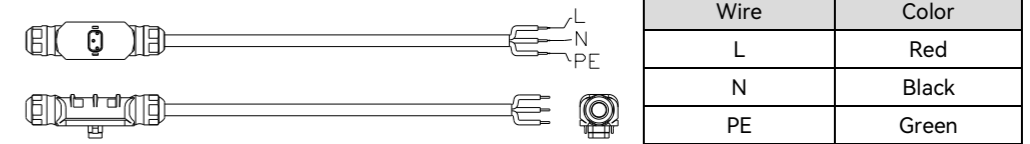

Figure 4.2
Connector wiring

(1) If the micro-inverter is connected to 120/240V split-phase power grid, connect two live lines to port L and port N.

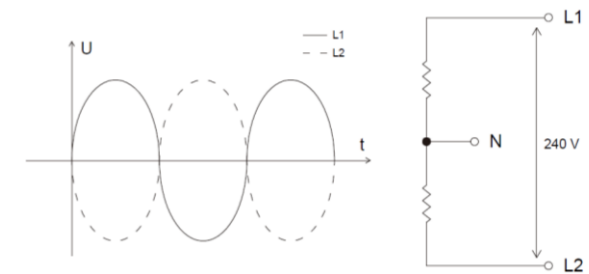

Figure 4.3
Split-phase power grid

(2) If the micro-inverter is connected to 230/400V three-phase WYE power grid, connect the live line to port L and connect the neutral line to port N, as the connection of single-phase power grid.

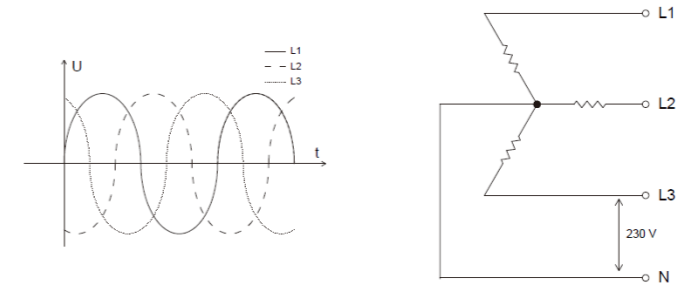

Figure 4.4
Three-phase WYE power grid

(3) If the micro-inverter is connected to 127/220 V three-phase power grid, connect one live line to port L and connect another live line to port N.

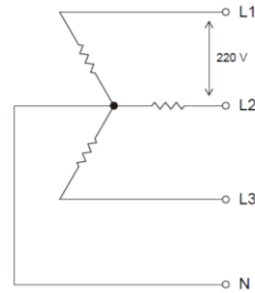

Figure 4.5
three-phase power grid

Step 2: For single-machine system, connect the branch male connector.

Before wiring, use a Phillips screwdriver to remove the screws to the uppermost baffle. Insert the other main cable into the body shell and crimp the inner wires into the slot according to the L, PE, and N marks. Tighten the screws. Press the terminals into the shell and put the nut back into the port and tighten.

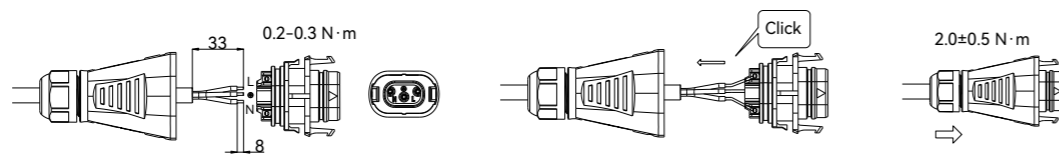

Figure 4.6
Connector wiring

For multi-machine system, prepare and install AC cables.

Use AC cables to connect the microinverters to the distribution box.

(1) Use the AC trunk connector unlock tool to align the slot on the back and press the nuts on both sides firmly.

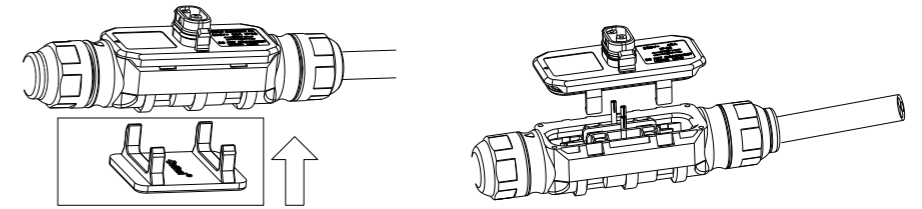

Figure 4.7
Unlock tool usage

(2) Insert the other main cable into the body shell and crimp the inner wires into the slot according to the L, PE, and N marks.

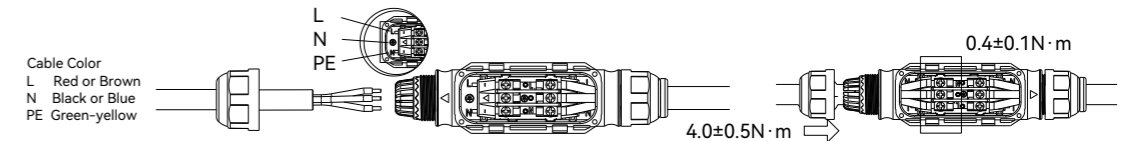

Figure 4.8
Inner wires crimping

Close the lid following guide arrows until a click sound is heard.

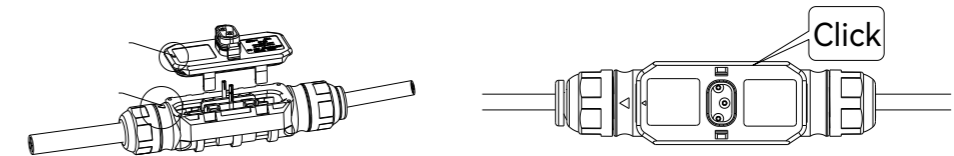

Figure 4.9
Closing the lid

(3) Prepare some AC trunk cables and string them in series for backup.

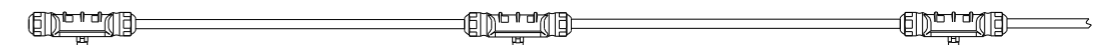

Figure 4.10
AC trunk cables in series

(4) Insert the AC trunk end cap to AC trunk cable, screw it and tighten the nut.

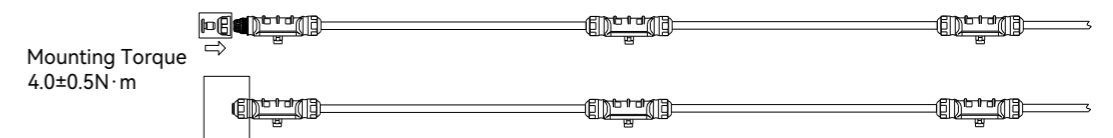

Figure 4.11
AC trunk cables tightening

(5) Lay the AC trunk cables on the guide rail and fix it with ties.

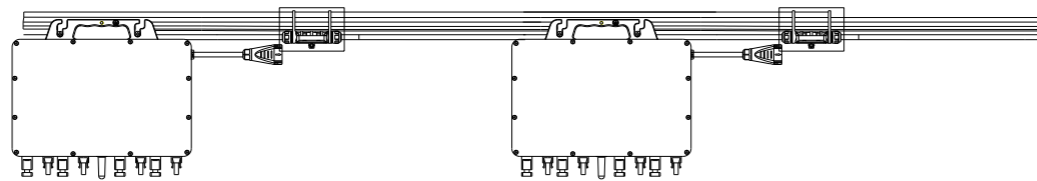

Figure 4.12
Fixing the cables with ties

Step 3: Complete AC Connection

(1) Insert the branch cable connector on output side into the AC trunk cable or branch male connector until a "click" sound is heard.

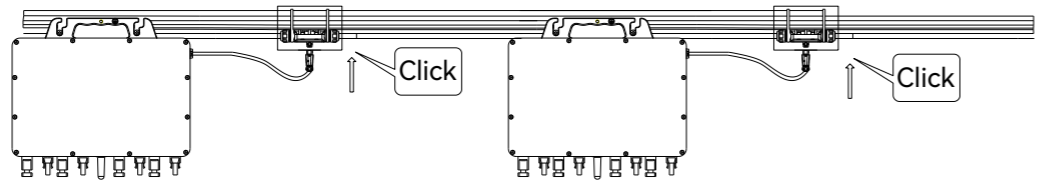

Figure 4.13
Multi-machine system

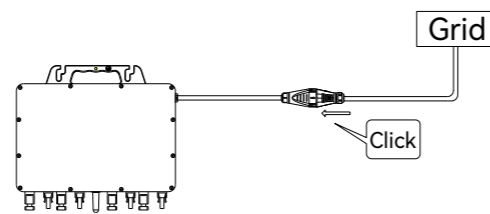

Figure 4.14
Single-machine system

(2) Connect the end of the AC cable to the distribution box and then connect it to the local power grid.

(3) If there is an empty port on the bus box, please insert the main cable protective cover into the empty port to ensure that the connector is dust-proof and waterproof.

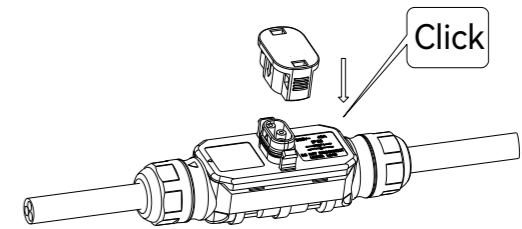

Figure 4.15
Single-machine system

Note: If you need to remove the output-side AC connector of the microinverter from AC trunk cable, please insert the branch connector unlock tool into the AC branch cable connector.

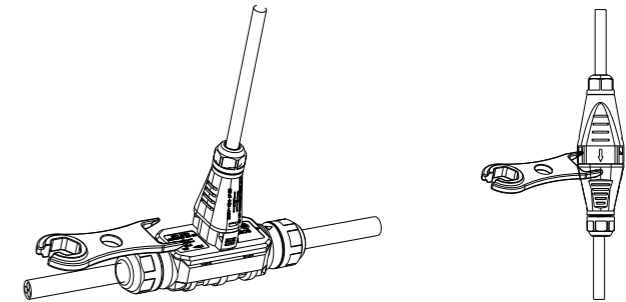

Figure 4.16
Single-machine system

Step 4: Make an Installation Map

Peel off the SN label on each microinverter and attach the SN label to the installation map as followed

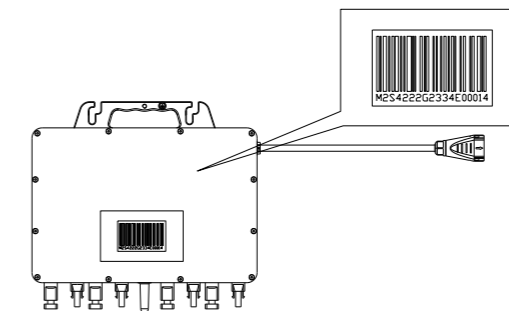

Figure 4.17
SN label and installation map

Appendix : Micro-inverter Installation Map

Customer (Name of customer or power station)	Installation Direction (Direction that the PV modules face to)	Installation Site (If there are other installation sites, use different installation maps and give them different Map No.)	1	2	3	4	5	6	7	8	9	10	11	12	13	14
A																
B																
C																

NOTICE

- If there are more than one installation site, please make the installation map separately and give a clear description about the installation site.
- The row of the table corresponds the shorter side of PV module and the column of the table corresponds the longer side of PV module. The direction on the upper left corner means the actual installation orientation.
- The micro-inverter SN label start with "T". The monitor SN label start with "R".

4.4 DC Side Cable Connection

Install the PV modules and connect the DC cable to the micro-inverter.

ATTENTION: The DC cable length from the PV array to the inverter must be smaller than 3 meters to meet relevant regulatory requirements. Ensure that the DC cables are correctly connected. For details, consult your local electric power operator and refer to local regulatory requirements.

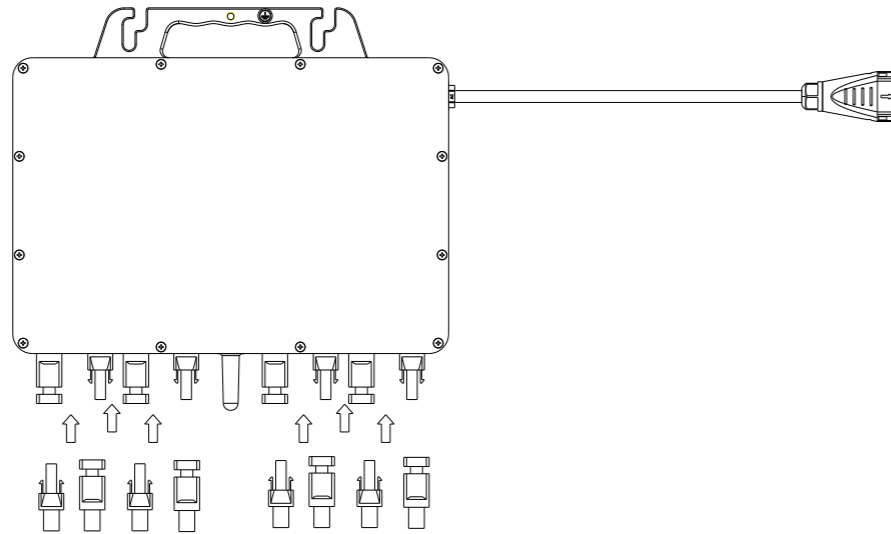

Figure 4.18
DC cable connection

4.5 PV Module Connection

Connecting the PV Modules

Install PV modules above microinverters. Connect DC output cable of PV modules to the DC input side of microinverters.

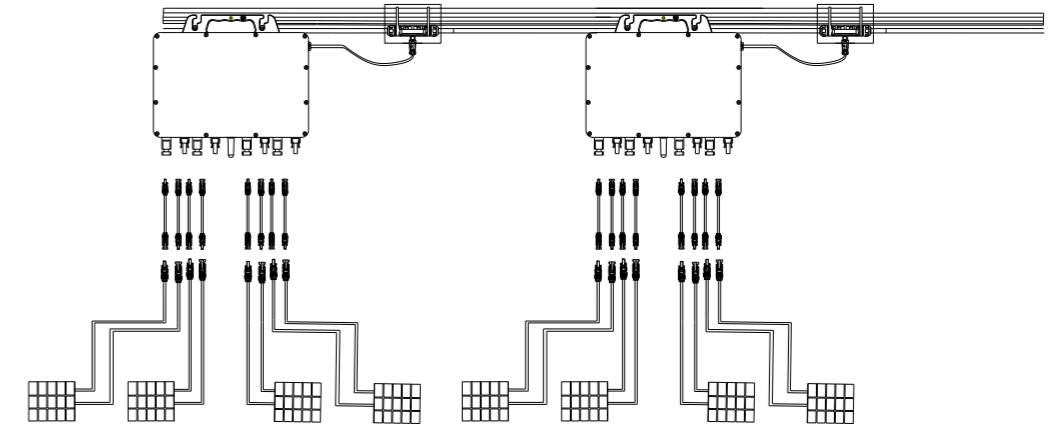

Figure 4.19
Multi-machine PV connection

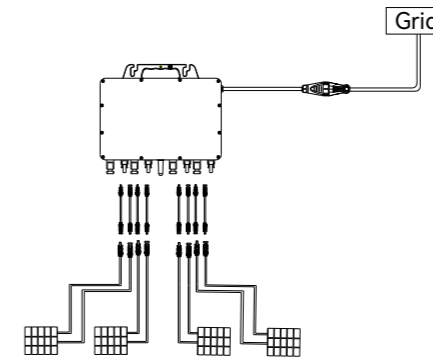

Figure 4.20
Single-machine PV connection

5.

COMMISSIONING



5.1 Start Up and Shut Down the Micro-Inverter

5.1.1 Start Up

Step 1: While installation is all finished, turn on the main utility-grid AC circuit breaker.

Step 2: Wait for two minutes and your system will start running.

5.1.2 Shut Down

Step1: Disconnect the micro-inverter and PV modules.

Step 2: The LED indicator will light off and the system will shut down.

5.1.3 Introduction of the LED Indicator

The LED will flash green and red at start up. The definition of LED is shown as below.

Status		Indicates
Green	Solid	Working normally
Green	Breathing	Standby/Waiting
Red	Flashing 1	Unable to connect
Red	Solid	Fault
Red	Breathing	Upgrading
Red & Green	Off	Not working

Note: 1. The breathing cycle is 6s;

2. Flashing 1 is one cycle lighting up for 1s and off for 1s.

3. Flashing 2 is one cycle lighting up for 1s and off for 3s

5.2 APP Connection

5.2.1 Downloading the App

1. The Elekeeper (used to be called eSAJ Home) can be used for both nearby and remote monitoring. It supports Bluetooth, 4G and Wi-Fi module to communicate with the device.

2. On your mobile phone, search for “**Elekeeper**” in the App store and download the App.

5.2.2 Logging in to the App

Procedure

1. Open the App and click on the three-dot icon  on the top right corner.
2. Set the **Language** to **English** and **Network Node** to **Overseas Node**.

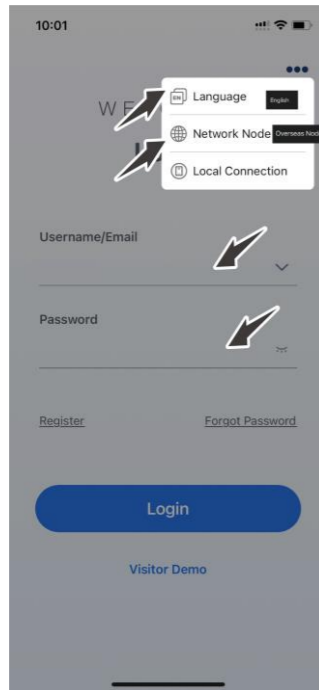

3. If you do not have an account, register first.
 - a. Click **Register**. Choose whether you are an owner or an installer or distributor.
 - b. Follow the instructions on the screen to complete the registration.
4. Use the account and password to log in to the App.
5. Go to the **Tool** interface and select **Remote Configuration**. Click on **Bluetooth** and enable the Bluetooth function on your mobile phone. Then, click on **Next**.

5.2.3 Completing the Initialization Settings

Follow the instructions on the screen.

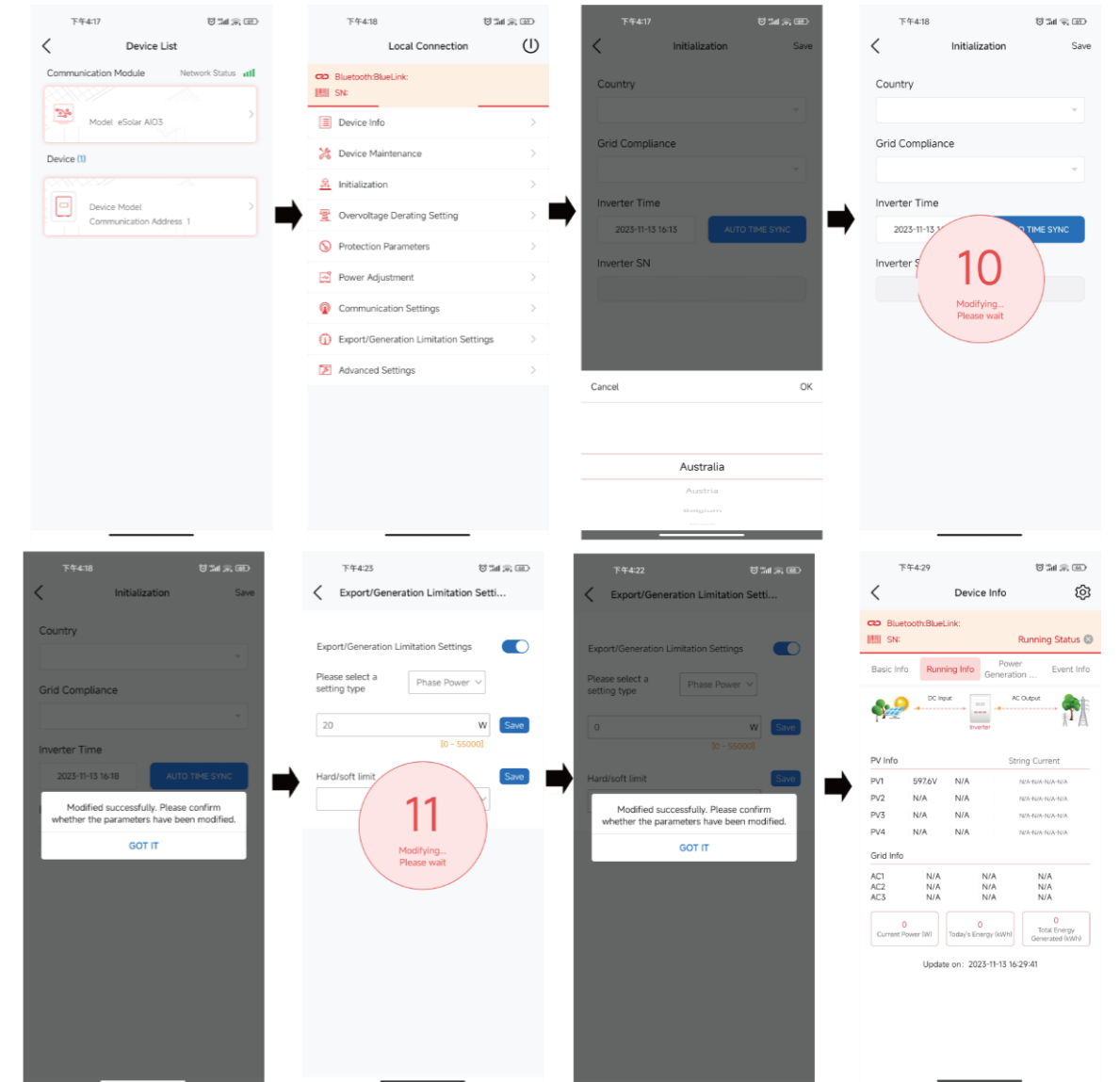

5.2.4 Bluetooth Connection

- Step 1: Log in, and go to “Service” interface, and select “Remote Configuration”.
- Step 2: Click on “Bluetooth”, and then click on “Next”
- Step 3: Select your device, and click “WiFi Configuration”
- Step 4: Select your WiFi and enter the WiFi passwords, then choose your correct router
- Step 5: Click the right arrow of your device, and click “Initialization” to configure the inverter
- Step 6: Enter the device local connection interface and enter the device basic information for operation data.

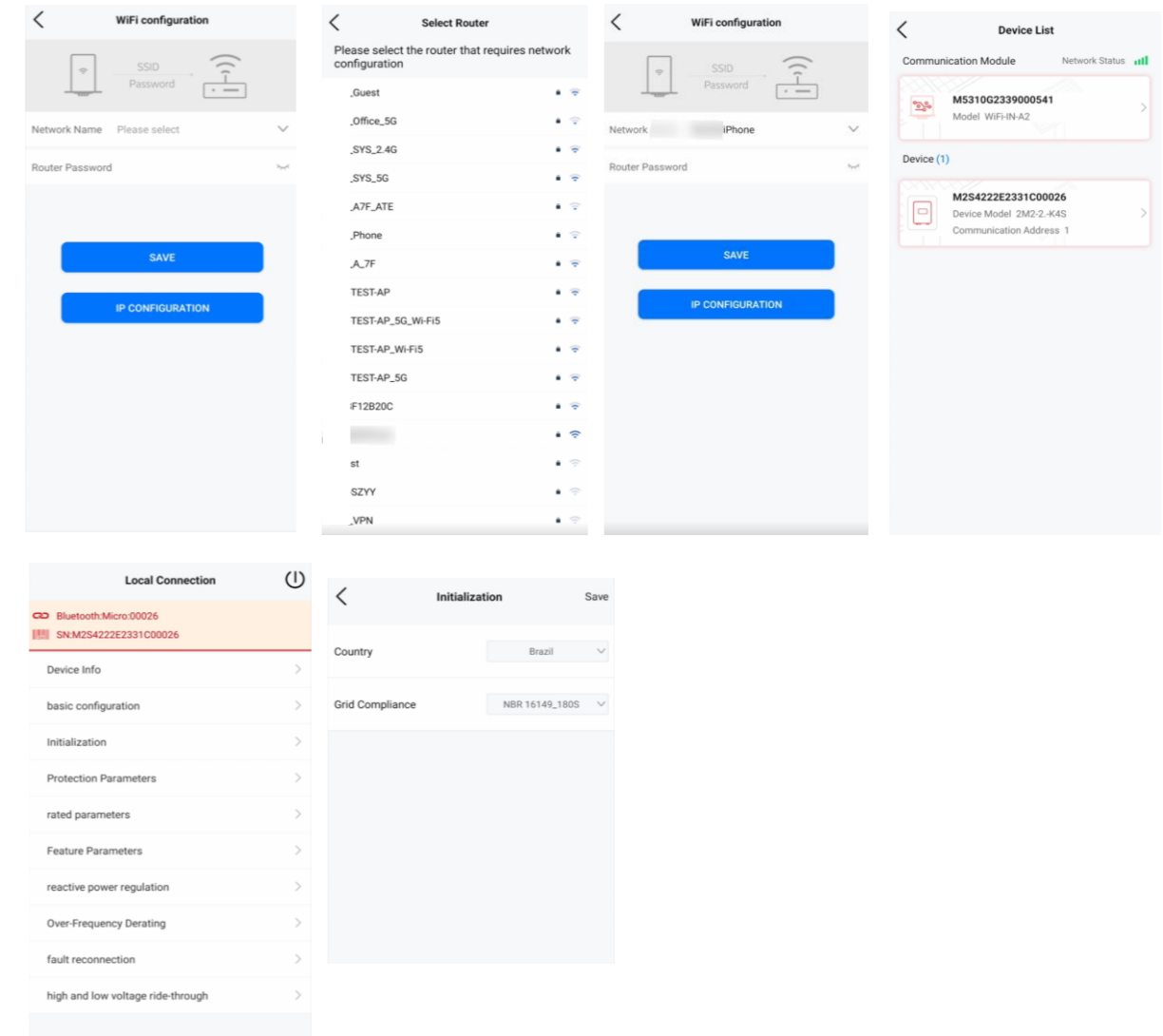
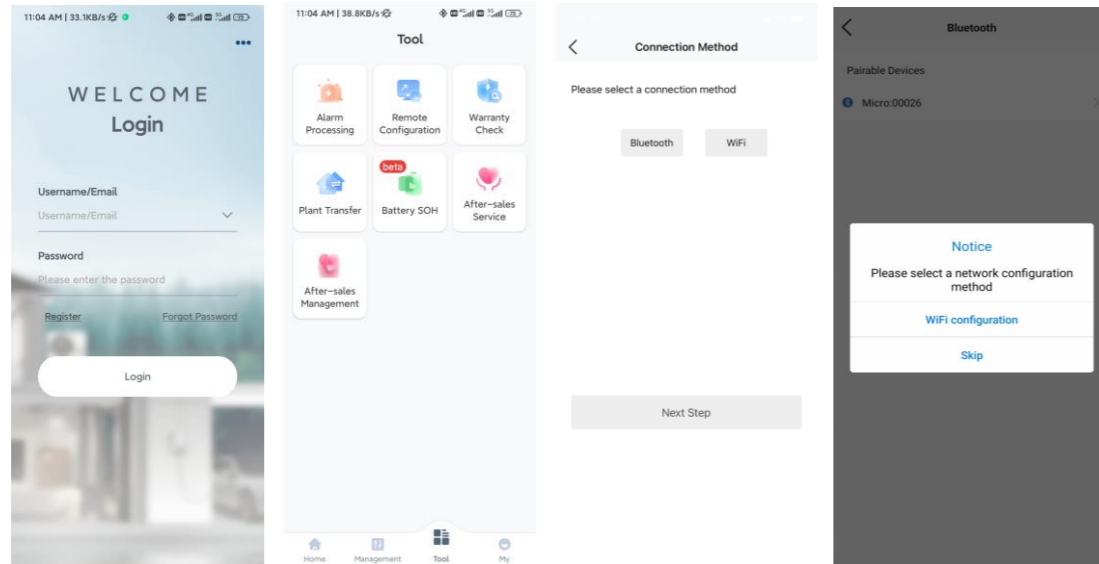

5.2.5 Plant Creation

Step 1: Enter the Management page, click the + button in the upper right corner, then Create Plant for Me

Step 2: Fill in the inverter SN, click the + button to read the device information, then click Next.

Step 3: Fill in the plant basic information, and then enter the Plant list page.

Step 4: Click on the plant information and enter the plant details page

Step 5: Enter the Micro Plant page, then click on the picture and click on the power view for details

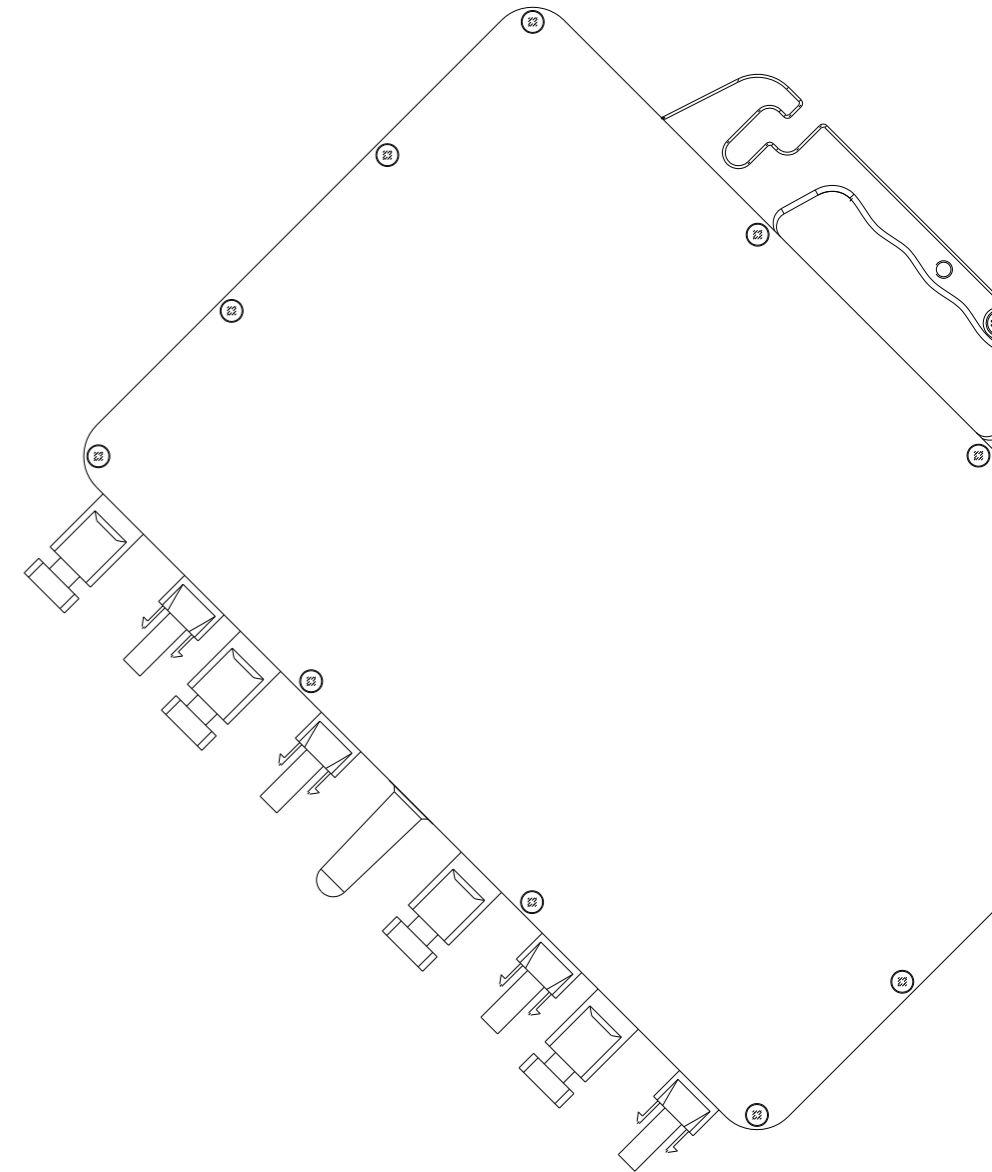
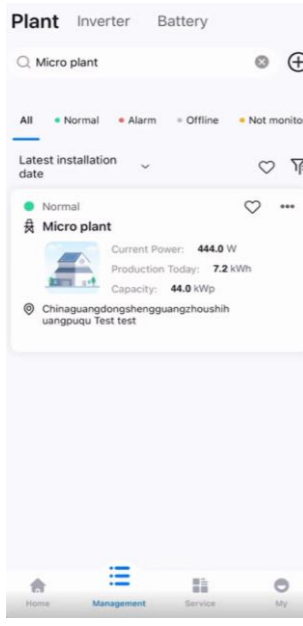
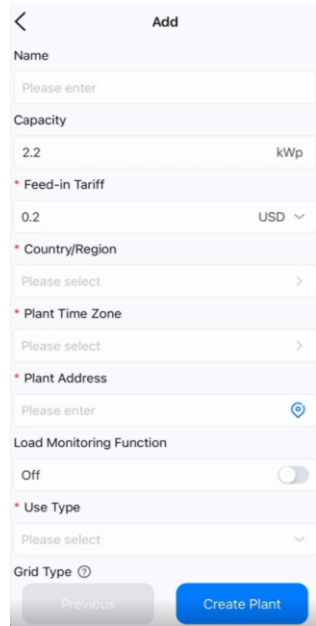
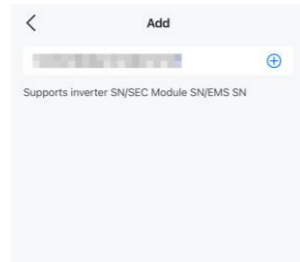
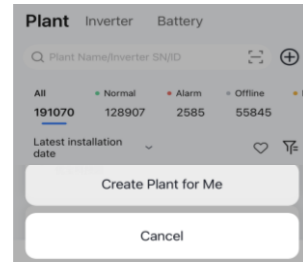
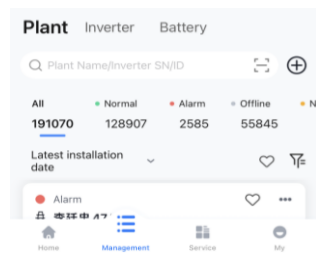

Troubleshooting

Code	Fault Information	Troubleshooting
1	Master Bus Voltage High	Disconnect the AC switch for 5-10 minutes, and check whether the fault disappears. Restart the inverter. If this fault appears continuously, please contact the SAJ service.
2	Master Bus Voltage Low	Restart the inverter. If this fault appears continuously, please contact the SAJ service.
3	Master Islanding Error	Please check whether the power grid is powered off, whether the grid-connected box switch is tripped, and whether the AC cable of the inverter is connected firmly. After the above inspections and there is no power failure or disconnection, or insecure connection, please close the AC switch and re-connect to the grid. If this fault appears continuously, please contact the SAJ service.
4	Master Adc Sample Error	Disconnect the AC and DC switch for 5 minutes, and then restart the inverter. If this fault appears continuously, please contact the SAJ service.
5	Frequency Config Error	Please check whether the safety regulations are selected correctly. Disconnecting the AC and DC switch for 5 minutes, and then restart the inverter. If this fault appears continuously, please contact the SAJ service.
6	Master EEPROM Error	Restart the inverter. If this fault appears continuously, please contact the SAJ service.
7	Master Temperature High Error	Please check whether the heat dissipation shell of the inverter is wrapped or covered by other items. Please check whether the inverter is installed in a place exposed to direct sunlight. Please check whether the installation environment is well-ventilated. If this fault appears continuously, please contact the SAJ service.
8	Master Temperature Low Error	Please check whether the ambient temperature at the inverter installation location is too low. If this fault appears continuously, please contact the SAJ service.
9	ISO Error	Disconnect the AC switch, and please check whether the ground wire of the AC output terminal is firm, and whether the AC wiring is correct.



6. FAULT CODE & TROUBLESHOOTING

Code	Fault Information	Troubleshooting
		Please check whether the AC and DC cables are damaged, whether they are soaked in water, and whether the battery board is soaked in water. After the above checks are confirmed, please close the AC switch and restart the inverter. If this fault appears continuously, please contact the SAJ service.
10	Output Current Dci High	Disconnect the AC switch for 5 minutes and then restart the inverter. If this fault appears continuously, please contact the SAJ service.
12	Master HW Inv Current High	Disconnect the AC switch and check whether the AC cable is firmly connected; After the above checks are confirmed, please close the AC switch and restart the inverter. If this fault appears continuously, please contact the SAJ service.
13	Master SW Inv Current High	
14	Grid Voltage 10Min High	Please check whether the grid voltage is too high, whether the AC output cable of the inverter is connected firmly and whether the grid-connected cable is too thin.
15	Grid Voltage High	Please check whether the grid-connected safety regulations of the inverter are selected correctly. If this fault appears continuously, please contact the SAJ service.
16	Grid Voltage Low	Please check whether the grid voltage is too low. Please check whether the AC output cable of the inverter is firmly connected. Please check whether the grid-connected safety regulations of the inverter are selected correctly. If this fault appears continuously, please contact the SAJ service.
17	Master Grid Frequency High	Please check whether the grid-connected safety regulations of the inverter are selected correctly. After disconnecting the AC switch for 5 minutes, close the AC switch and restart the inverter. If this fault appears continuously, please contact the SAJ service.
18	Master Grid Frequency Low	Please check whether the grid-connected safety regulations of the inverter are selected correctly. After disconnecting the AC switch for 5 minutes, close the AC switch and restart the inverter. If this fault appears continuously, please contact the SAJ service.

Code	Fault Information	Troubleshooting
19	Master No Grid Error	Please confirm whether the power grid is powered off, whether the grid-connected box switch is tripped, and whether the AC cable of the inverter is connected firmly. After the above inspections confirm that there is no power failure or disconnection, or insecure connection, please close the AC switch and re-connect to the grid, If this fault appears continuously, please contact the SAJ service.
20	Master PV1 Voltage High Error	Please check whether the open-circuit voltage of each battery panel exceeds the maximum input voltage of the inverter. After the above checks are confirmed, please close the AC switch and restart the inverter. If this fault appears continuously, please contact the SAJ service.
21	Master PV2 Voltage High Error	
22	Master PV3 Voltage High Error	
23	Master PV4 Voltage High Error	
24	Master HW PV1 Current High	Please check whether the positive and negative poles of the battery board are reversed. After the above checks are confirmed, please close the AC switch and restart the inverter. If this fault appears continuously, please contact the SAJ service.
25	Master SW PV1 Current High	
26	Master HW PV2 Current High	
27	Master SW PV2 Current High	
28	Master HW PV3 Current High	
29	Master SW PV3 Current High	
30	Master HW PV4 Current High	
31	Master SW PV4 Current High	
32	Master Relay Error	Automatic recovery, the recovery wait time is 10 minutes, and it will not recover after a total of 4 times. If this fault appears continuously, please contact the SAJ service.

7.

RECYCLING & DISPOSAL



This device should not be disposed of as residential waste. An Inverter that has reached the end of its life is not required to be returned to your dealer. It must be disposed of carefully by an approved collection and recycling facility in your area.

Contact SAJ

Guangzhou Sanjing Electric Co., Ltd.

SAJ Innovation Park, No.9, Lizhishan Road, Guangzhou Science City, Guangdong, P.R.China.

Postcode: 510663

Web: <http://www.saj-electric.com>

Technical Support & Service

Tel: +86 20 6660 8588

Fax: +86 20 6660 8589

E-mail: service@saj-electric.com

International Sales

Tel: 86-20-66608618/66608619/66608588/66600086

Fax: 020-66608589

E-mail: info@saj-electric.com

Domestic Sales

Tel: 020-66600058/66608588

Fax: 020-66608589