



SUNNY BOY 3.0 / 3.6 / 4.0 / 5.0 / 6.0

Important information

Depending on availability, the product is or is not equipped with Wi-Fi functionality. The reason for this is the currently problematic semiconductor supply, caused by the COVID-19 pandemic.

If the product is not equipped with Wi-Fi functionality, please use the standard Ethernet communication interface included for commissioning, configuration and integrating the product into a network.

If integrating the product into a Wi-Fi network is absolutely necessary, this can be done using a commercial Wi-Fi repeater, which is connected to the product via Ethernet.

Without the Wi-Fi function, a direct connection to the user interface by scanning the QR code on the product with the SMA 360° app is not possible. Use a different type of connection.

Legal Provisions

The information contained in these documents is the property of SMA Solar Technology AG. No part of this document may be reproduced, stored in a retrieval system, or transmitted, in any form or by any means, be it electronic, mechanical, photographic, magnetic or otherwise, without the prior written permission of SMA Solar Technology AG. Internal reproduction used solely for the purpose of product evaluation or other proper use is allowed and does not require prior approval.

SMA Solar Technology AG makes no representations or warranties, express or implied, with respect to this documentation or any of the equipment and/or software it may describe, including (with no limitation) any implied warranties of utility, merchantability, or fitness for any particular purpose. All such representations or warranties are expressly disclaimed. Neither SMA Solar Technology AG nor its distributors or dealers shall be liable for any indirect, incidental, or consequential damages under any circumstances.

The exclusion of implied warranties may not apply in all cases under some statutes, and thus the above exclusion may not apply.

Specifications are subject to change without notice. Every attempt has been made to make this document complete, accurate and up-to-date. Readers are cautioned, however, that product improvements and field usage experience may cause SMA Solar Technology AG to make changes to these specifications without advance notice or per contract provisions. SMA Solar Technology AG shall not be responsible for any damages, including indirect, incidental or consequential damages, caused by reliance on the material presented, including, but not limited to, omissions, typographical errors, arithmetical errors or listing errors in the content material.

SMA Warranty

You can download the current warranty conditions from the Internet at www.SMA-Solar.com.

Software licenses

The licenses for the installed software modules (open source) can be found in the user interface of the product.

Trademarks

All trademarks are recognized, even if not explicitly identified as such. Missing designations do not mean that a product or brand is not a registered trademark.

SMA Solar Technology AG

Sonnenallee 1

34266 Niestetal

Germany

Tel. +49 561 9522-0

Fax +49 561 9522-100

www.SMA.de

E-mail: info@SMA.de

Status: Wednesday, July 10, 2024

Copyright © 2024 SMA Solar Technology AG. All rights reserved.

Table of Contents

1	Information on this Document.....	7
1.1	Validity	7
1.2	Target Group.....	7
1.3	Content and Structure of this Document	7
1.4	Levels of Warning Messages	7
1.5	Symbols in the Document	8
1.6	Typographies in the document	8
1.7	Designations in the Document	8
1.8	Additional Information	9
2	Safety	10
2.1	Intended Use	10
2.2	IMPORTANT SAFETY INFORMATION.....	11
3	Scope of delivery	16
4	Product overview	17
4.1	Product Description	17
4.2	Symbols on the Product	18
4.3	Interfaces and Functions	19
4.4	LED Signals.....	23
4.5	System Overview	24
4.5.1	Circuitry Overview	25
4.5.2	Communication Overview.....	26
5	Mounting	27
5.1	Requirements for Mounting	27
5.2	Mounting the product	29
6	Electrical Connection.....	31
6.1	Overview of the Connection Area	31
6.2	AC Connection.....	31
6.2.1	Requirements for the AC Connection	31
6.2.2	Connecting the Inverter to the Utility Grid.....	33
6.2.3	Connecting Additional Grounding	35
6.2.4	Equipotential Bonding	35
6.3	Connecting the Network Cables.....	36
6.4	Connecting RS485 Devices.....	37
6.5	Mounting the WLAN Antenna	38
6.6	DC connection.....	39

6.6.1	Requirements for the DC Connection	39
6.6.2	Assembling the DC Connectors	41
6.6.3	Connecting the PV Array	43
6.6.4	Disassembling the DC Connectors	45
7	Commissioning	47
7.1	Commissioning Procedure	47
7.2	Commissioning the Inverter.....	48
7.3	Selecting a configuration option	49
7.4	Starting the Self-Test (for Italy and Dubai).....	51
8	Operation	53
8.1	Establishing a connection to the user interface	53
8.1.1	Establishing a Direct Connection via Ethernet.....	53
8.1.2	Establishing a direct connection via WLAN.....	53
8.1.3	Establishing a Connection via Ethernet in the local network.....	55
8.1.4	Establishing a Connection via WLAN in the Local Network	56
8.2	Logging In and Out of the User Interface.....	57
8.3	Start Page Design of the User Interface.....	59
8.4	Activating the Smart Inverter Screen.....	62
8.5	Starting the Installation Assistant.....	62
8.6	Activate WPS Function.....	63
8.7	Switching WLAN On and Off.....	64
8.8	Switching the Dynamic Power Display Off.....	64
8.9	Changing the Password.....	65
8.10	Generating or Changing a Product Key.....	65
8.11	Configuring the Service Access.....	66
8.12	Changing Operating Parameters.....	67
8.13	Configuring the Country Data Set.....	68
8.14	Configuring the Active Power Mode	69
8.15	Configuring the Modbus Function.....	70
8.16	Activating the Receipt of Control Signals (Only for Italy).....	70
8.17	Deactivating Grounding Conductor Monitoring	71
8.18	Setting SMA ShadeFix.....	71
8.19	Generating characteristic curves.....	72
8.20	Setting the Rated Residual Current of the Residual-Current Device	73
8.21	Activating or Deactivating SMA ArcFix	73
8.22	Saving the Configuration in a File.....	73
8.23	Adopting a Configuration from a File.....	74
8.24	Firmware Update	74
8.24.1	Activating Automatic Firmware Update	74

8.24.2	Updating Firmware with Update File via the User Interface.....	75
8.24.3	Searching for and Installing New Firmware via the User Interface	75
9	Disconnecting the Inverter from Voltage Sources.....	77
10	Cleaning the Product	80
11	Troubleshooting	81
11.1	Product Key Lost.....	81
11.2	Event messages	81
11.3	Checking the PV System for Ground Faults	105
11.4	Problems with streaming services	108
12	Decommissioning the Inverter	109
13	Technical Data	112
13.1	DC/AC	112
13.1.1	Sunny Boy 3.0 / 3.6 / 4.0	112
13.1.2	Sunny Boy 5.0 / 6.0	114
13.2	General Data	116
13.3	Climatic Conditions	117
13.4	Protective Devices	117
13.5	Equipment	118
13.6	Torques	118
13.7	Data Storage Capacity.....	118
14	Contact	119
15	EU Declaration of Conformity	120
16	UK Declaration of Conformity	121

1 Information on this Document

1.1 Validity

This document is valid for:

- SB3.0-1AV-41 (Sunny Boy 3.0) from firmware version $\geq 4.00.00.R$
- SB3.6-1AV-41 (Sunny Boy 3.6) from firmware version $\geq 4.00.00.R$
- SB4.0-1AV-41 (Sunny Boy 4.0) from firmware version $\geq 4.00.00.R$
- SB5.0-1AV-41 (Sunny Boy 5.0) from firmware version $\geq 4.00.00.R$
- SB6.0-1AV-41 (Sunny Boy 6.0) from firmware version $\geq 4.00.00.R$

1.2 Target Group

This document is intended for qualified persons and end users. Only qualified persons are allowed to perform the activities marked in this document with a warning symbol and the caption "Qualified person". Tasks that do not require any particular qualification are not marked and can also be performed by end users. Qualified persons must have the following skills:

- Knowledge of how to safely disconnect SMA inverters
- Knowledge of how an inverter works and is operated
- Training in how to deal with the dangers and risks associated with installing, repairing and using electrical devices and installations
- Training in the installation and commissioning of electrical devices and installations
- Knowledge of all applicable laws, regulations, standards, and directives
- Knowledge of and compliance with this document and all safety information

1.3 Content and Structure of this Document

This document describes the mounting, installation, commissioning, configuration, operation, troubleshooting and decommissioning of the product as well as the operation of the product user interface.

You will find the latest version of this document and further information on the product in PDF format and as eManual at www.SMA-Solar.com. You can also call up the eManual via the user interface of the product.

Illustrations in this document are reduced to the essential information and may deviate from the real product.

1.4 Levels of Warning Messages

The following levels of warning messages may occur when handling the product.

DANGER

Indicates a hazardous situation which, if not avoided, will result in death or serious injury.

WARNING

Indicates a hazardous situation which, if not avoided, could result in death or serious injury.



⚠ CAUTION

Indicates a hazardous situation which, if not avoided, could result in minor or moderate injury.

NOTICE

Indicates a situation which, if not avoided, can result in property damage.

1.5 Symbols in the Document

Symbol	Explanation
	Information that is important for a specific topic or goal, but is not safety-relevant
<input type="checkbox"/>	Indicates a requirement for meeting a specific goal
<input checked="" type="checkbox"/>	Required result
	Example
⚠ QUALIFIED PERSON	Sections describing activities to be performed by qualified persons only

1.6 Typographies in the document

Typography	Use	Example
bold	<ul style="list-style-type: none"> Messages Terminals Elements on a user interface Elements to be selected Elements to be entered 	<ul style="list-style-type: none"> Connect the insulated conductors to the terminals X703:1 to X703:6. Enter 10 in the field Minutes.
>	<ul style="list-style-type: none"> Connects several elements to be selected 	<ul style="list-style-type: none"> Select Settings > Date.
[Button] [Key]	<ul style="list-style-type: none"> Button or key to be selected or pressed 	<ul style="list-style-type: none"> Select [Enter].
#	<ul style="list-style-type: none"> Placeholder for variable components (e.g., parameter names) 	<ul style="list-style-type: none"> Parameter WCtHz.Hz#

1.7 Designations in the Document

Complete designation	Designation in this document
Sunny Boy	Inverter, product

1.8 Additional Information

For more information, please go to www.SMA-Solar.com.

Title and information content	Type of information
"PUBLIC CYBER SECURITY - Guidelines for a Secure PV System Communication"	Technical Information
"SMA GRID GUARD 10.0 - Grid Management Services via Inverter and System Controller"	Technical Information
"Parameter settings for operation in the Delta IT grid in compliance with Synergrid C10/C11:2019 and EN50549-1:2019 LV"	Technical Information
"Efficiency and Derating" Efficiency and derating behavior of the SMA inverters	Technical Information
"Parameters and Measured Values" Overview of all inverter operating parameters and their configuration options as well as an overview of all SMA Modbus registers	Technical Information
"SUNSPEC MODBUS" Information on the activation of the SunSpec Modbus interface and information on the SunSpec Modbus profiles	Technical Information
"SMA MODBUS" Information on the SMA Modbus interface as well as an overview of all SMA Modbus registers	Technical Information
"SMA SPEEDWIRE FIELDBUS"	Technical information
"RS485 Cabling Plan"	Installation Manual
"Temperature Derating"	Technical Information
"I-V and P-V diagnostics function: Using the inverter to determine the generator's characteristic curve to detect faults in PV modules"	Technical Information

2 Safety

2.1 Intended Use

The Sunny Boy is a transformerless PV inverter with 2 MPP trackers, which convert the direct current of the PV modules into grid-compliant alternating current and feeds it into the utility grid.

The product is suitable for indoor and outdoor use.

The product must only be operated with PV modules of protection class II in accordance with IEC 61730, application class A. The PV modules must be compatible with this product.

The product is not equipped with an integrated transformer and therefore has no galvanic isolation. The product must not be operated with PV modules whose outputs are grounded. This can cause the product to be destroyed. The product may be operated with PV modules whose frame is grounded.

PV modules with a high capacity to ground must only be used if the coupling capacity of all PV modules does not exceed 1.4 μF (for information on how to determine the coupling capacity, see the Technical Information "Leading Leakage Currents" at www.SMA-Solar.com).

All components must remain within their permitted operating ranges and their installation requirements at all times.

The products by SMA Solar Technology AG are not suitable for use in

- Medical devices, in particular products for supplying life-support systems and machines,
- Aircraft, the operation of aircraft, the supply of critical airport infrastructure and airport systems,
- Rail vehicles, the operation and supply of rail vehicles and their critical infrastructure.

The above list is not exhaustive. Contact us if you are unsure whether products by SMA Solar Technology AG are suitable for your application.

The product must only be used in countries for which it is approved or released by SMA Solar Technology AG and the grid operator.

The installation of the product in Brazil must meet the current technical standards for "Electrical installations of photovoltaic arrangements" (NBR 16690) and the "Managing fire risk related to photovoltaic (PV) systems on buildings" (IEC 63226).

Use SMA products only in accordance with the information provided in the enclosed documentation and with the locally applicable laws, regulations, standards and directives. Any other application may cause personal injury or property damage.

The documentation must be strictly followed. Deviations from the described actions and the use of materials, tools, and aids other than those specified by SMA Solar Technology AG are expressly forbidden.

Alterations to the SMA products, e.g., changes or modifications, are only permitted with the express written permission of SMA Solar Technology AG. Unauthorized alterations as well as failure to observe the documentation will void guarantee and warranty claims and in most cases terminate the operating license. SMA Solar Technology AG shall not be held liable for any damage caused by such changes.

Any use other than that described in the Intended Use section does not qualify as appropriate.

The documentation must be strictly followed. Deviations from the described actions and the use of materials, tools, and aids other than those specified by SMA Solar Technology AG are expressly forbidden.

The documentation supplied is an integral part of SMA products. Keep the documentation in a convenient, dry place for future reference and observe all instructions contained therein.

This document does not replace any regional, state, provincial, federal or national laws, regulations or standards that apply to the installation, electrical safety and use of the product. SMA Solar Technology AG assumes no responsibility for the compliance or non-compliance with such laws or codes in connection with the installation of the product.

The type label must remain permanently attached to the product.

2.2 IMPORTANT SAFETY INFORMATION

Keep the manual for future reference.

This section contains safety information that must be observed at all times when working.

The product has been designed and tested in accordance with international safety requirements. As with all electrical or electronic devices, some residual risks remain despite careful construction. To prevent personal injury and property damage and to ensure long-term operation of the product, read this section carefully and observe all safety information at all times.

DANGER

Danger to life due to electric shock when live components or DC cables are touched

When exposed to light, the PV modules generate high DC voltage which is present in the DC cables. Touching live DC cables results in death or lethal injuries due to electric shock.

- Do not touch non-insulated parts or cables.
- Disconnect the product from voltage sources and ensure it cannot be reconnected before working on the device.
- Wear suitable personal protective equipment for all work on the product.

DANGER

Danger to life due to electric shock when live components are touched on opening the product

High voltages are present in the live parts and cables inside the product during operation. Touching live parts and cables results in death or lethal injuries due to electric shock.

- Do not open the product.

 DANGER**Danger to life due to electric shock from touching an ungrounded PV module or array frame**

Touching ungrounded PV modules or array frames results in death or lethal injuries due to electric shock.

- Connect and ground the frame of the PV modules, the array frame and the electrically conductive surfaces so that there is continuous conduction. Observe the applicable local regulations.

 DANGER**Danger to life due to electric shock when touching live system components in case of a ground fault**

If a ground fault occurs, parts of the system may still be live. Touching live parts and cables results in death or lethal injuries due to electric shock.

- Disconnect the product from voltage sources and ensure it cannot be reconnected before working on the device.
- Only touch the cables of the PV modules on their insulation.
- Do not touch any parts of the substructure or frame of the PV array.
- Do not connect PV strings with ground faults to the inverter.

 DANGER**Danger to life due to electric shock in case of overvoltages and if surge protection is missing**

Overvoltages (e.g., in the event of a flash of lightning) can be further conducted into the building and to other connected devices in the same network via the network cables or other data cables if there is no surge protection. Touching live parts and cables results in death or lethal injuries due to electric shock.

- Ensure that all devices in the same network are integrated in the existing overvoltage protection.
- When laying the network cable outdoors, ensure that there is suitable surge protection at the network cable transition from the product outdoors to the network inside the building.
- The Ethernet interface of the product is classified as "TNV-1" and offers protection against overvoltages of up to 1.5 kV.

⚠ WARNING**Danger to life due to fire and explosion**

In rare cases, an explosive gas mixture can be generated inside the product under fault conditions. In this state, switching operations can cause a fire inside the product or explosion.

Death or lethal injuries due to hot or flying debris can result.

- In the event of a fault, do not perform any direct actions on the product.
- Ensure that unauthorized persons have no access to the product.
- Do not operate the DC load-break switch on the inverter in case of an error.
- Disconnect the PV array from the inverter via an external disconnection device. If there is no disconnecting device present, wait until no more DC power is applied to the inverter.
- Disconnect the AC circuit breaker, or keep it disconnected in case it has already tripped, and secure it against reconnection.
- Only perform work on the product (e.g., troubleshooting, repair work) when wearing personal protective equipment for handling of hazardous substances (e.g., safety gloves, eye and face protection, respiratory protection).

⚠ WARNING**Risk of injury due to toxic substances, gases and dusts**

In rare cases, damages to electronic components can result in the formation of toxic substances, gases or dusts inside the product. Touching toxic substances and inhaling toxic gases and dusts can cause skin irritation, burns or poisoning, trouble breathing and nausea.

- Only perform work on the product (e.g., troubleshooting, repair work) when wearing personal protective equipment for handling of hazardous substances (e.g., safety gloves, eye and face protection, respiratory protection).
- Ensure that unauthorized persons have no access to the product.

⚠ WARNING**Danger to life due to electric shock from destruction of the measuring device due to overvoltage**

Overvoltage can damage a measuring device and result in voltage being present in the enclosure of the measuring device. Touching the live enclosure of the measuring device results in death or lethal injuries due to electric shock.

- Only use measuring devices with a DC input voltage range of 600 V or higher.

⚠ CAUTION**Risk of burns due to hot enclosure parts**

Some parts of the enclosure can get hot during operation. Touching hot enclosure parts can result in burn injuries.

- During operation, do not touch any parts other than the enclosure lid of the inverter.

⚠ CAUTION

Risk of injury due to weight of product

Injuries may result if the product is lifted incorrectly or dropped while being transported or mounted.

- Transport and lift the product carefully. Take the weight of the product into account.
- Wear suitable personal protective equipment for all work on the product.

NOTICE

High costs due to inappropriate Internet tariff

Depending on use, the data volume of the product transferred via the Internet may vary in size. The data volume depends, for example, on the number of devices in the system and the frequency of device updates. High costs for the Internet connection can be the result.

- SMA Solar Technology AG recommends using an Internet flat rate.

NOTICE

Damage to the product due to cleaning agents

The use of cleaning agents may cause damage to the product and its components.

- Clean the product and all its components only with a cloth moistened with clear water.

i Communication disturbances in the local network

The IP address range 192.168.12.0 to 192.168.12.255 is occupied for communication amongst SMA products and for direct access to SMA products.

Communication problems might occur if this IP address range is used in the local network.

- Do not use the IP address range 192.168.12.0 to 192.168.12.255 in the local network.

i Change to the names and units of grid parameters to comply with the grid-connection requirements in accordance with Regulation (EU) 2016/631 (valid from April 27, 2019)

To comply with the EU grid-connection requirements (valid from April 27, 2019) the names and units of grid parameters were changed. This change is valid from firmware version $\geq 3.00.00.R$ if a country data set for fulfilling the EU grid-connection requirements (valid from 2019-04-27) is set. Names and units of grid parameters for inverters with firmware version $\leq 2.99.99.R$ are not affected by this change and remain valid. This also applies from firmware version $\geq 3.00.00.R$ if a country data set that is valid for countries outside the EU is set.

i A country data set must be set for feed-in operation

From firmware version 4.00.00.R, the activation conditions for feed-in operation were changed.

To ensure the inverter begins feed-in operation during initial commissioning, a country data set must be set (for instance via the installation assistant on the user interface of the product, or via a communication product).

If no country data set is set, then feed-in operation will be stopped. This state is signaled by the green and red LEDs flashing simultaneously.

The inverter will automatically start feed-in operation only after the inverter configuration is completed.

i The country data set must be set correctly.

If you select a country data set which is not valid for your country and purpose, it can cause a disturbance in the PV system and lead to problems with the grid operator. When selecting the country data set, you must always observe the locally applicable standards and directives as well as the properties of the PV system (e.g. PV system size, grid-connection point).

- If you are not sure which standards and directives are valid for your country or purpose, contact the grid operator.

3 Scope of delivery

Check the scope of delivery for completeness and any externally visible damage. Contact your distributor if the scope of delivery is incomplete or damaged.

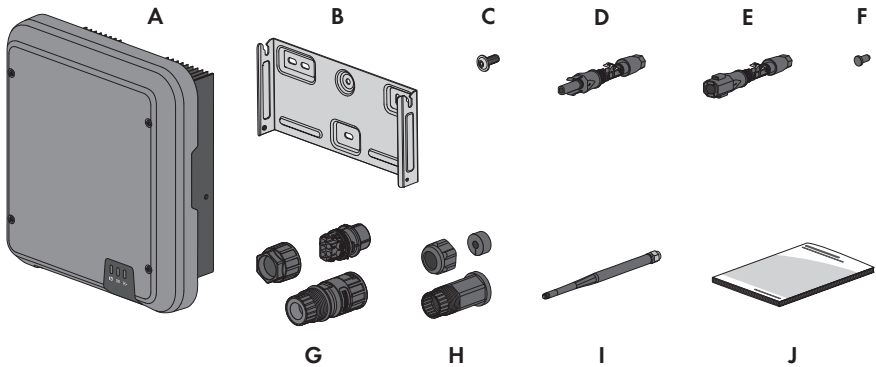

Figure 1: Components included in scope of delivery

Position	Quantity	Designation
A	1	Inverter
B	1	Wall mounting bracket
C	3	Pan head screw (M5x12)
D	4	Positive DC connector
E	4	Negative DC connector
F	8	Sealing plug
G	1	AC connector: swivel nut, threaded sleeve, terminal
H	1	RJ45 protective sleeve: swivel nut, cable support sleeve, threaded sleeve
I	1	Wi-Fi antenna (only available if the inverter is equipped with a Wi-Fi interface)
J	1	Quick reference guide with password label on the rear side The label contains the following information: <ul style="list-style-type: none"> • PIC (Product Identification Code) identification key for registering the system in Sunny Portal • RID (Registration Identifier) registration ID for registering the system in Sunny Portal • WLAN password WPA2-PSK (WiFi Protected Access 2 - Preshared Key) for direct connection to the inverter via WLAN

4 Product overview

4.1 Product Description

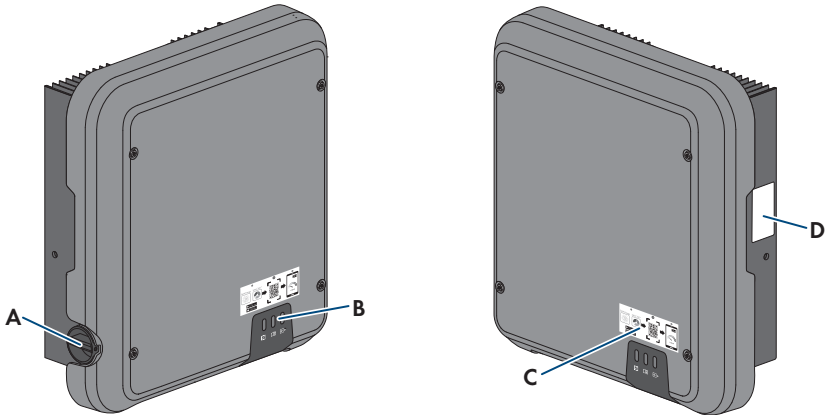





















Figure 2: Design of the product

Position	Designation
A	DC load-break switch
B	LEDs The LEDs indicate the operating state of the product.
C	Label with QR Code for scanning via the SMA 360° App and easy connection to the inverter's user interface via Wi-Fi (only available if the product is equipped with a Wi-Fi interface)
D	Type label The type label clearly identifies the product. The type label must remain permanently attached to the product. You will find the following information on the type label: <ul style="list-style-type: none"> • Device type (Model) • Serial number (Serial No. or S/N) • Date of manufacture • Identification key (PIC) for registration in Sunny Portal • Registration ID (RID) for registration in Sunny Portal • Wi-Fi password (WPA2-PSK) for the direct connection to the user interface of the product via Wi-Fi • Device-specific characteristics

4.2 Symbols on the Product

Symbol	Explanation
	Beware of a danger zone This symbol indicates that the product must be additionally grounded if additional grounding or equipotential bonding is required at the installation site.
	Beware of electrical voltage The product operates at high voltages.
	Beware of hot surface The product can get hot during operation.
	Danger to life due to high voltages in the inverter; observe a waiting time of 5 minutes. High voltages that can cause lethal electric shocks are present in the live components of the inverter. Prior to performing any work on the inverter, disconnect it from all voltage sources as described in this document.
	Observe the documentations Observe all documentations supplied with the product.
	Inverter Together with the green LED, this symbol indicates the operating state of the inverter.
	Observe the documentation Together with the red LED, this symbol indicates an error.
	Data transmission Together with the blue LED, this symbol indicates the status of the network connection.
	Grounding conductor This symbol indicates the position for connecting a grounding conductor.
	Alternating current
	Direct current

Symbol	Explanation
	The product has no galvanic isolation.
	WEEE designation Do not dispose of the product together with the household waste but in accordance with the disposal regulations for electronic waste applicable at the installation site.
	The product is suitable for outdoor installation.
IP65	Degree of protection IP65 The product is protected against the penetration of dust and water that is directed as a jet against the enclosure from all directions.
CE	CE marking The product complies with the requirements of the applicable EU directives.
UK CA	UKCA marking The product complies with the regulations of the applicable laws of England, Wales and Scotland.
	RoHS labeling The product complies with the requirements of the applicable EU directives.
	RCM (Regulatory Compliance Mark) The product complies with the requirements of the applicable Australian standards.
	ICASA The product complies with the requirements of the South African standards for telecommunication.
	ANATEL The product complies with the requirements of the Brazilian standards for telecommunication. Este equipamento opera em caráter secundário, isto é, não tem direito a proteção contra interferência prejudicial, mesmo de estações do mesmo tipo, e não pode causar interferência a sistemas operando em caráter primário.
	The product complies with the Moroccan safety and EMC requirements for electronic products.

4.3 Interfaces and Functions

The product is equipped with the following interfaces and functions:

User interface for configuration and monitoring

The product is equipped as standard with an integrated webserver, which provides a user interface for configuring and monitoring the product.

Once the connection has been established to the smart device, use a terminal (e.g. smartphone, tablet or laptop) to connect to the product's user interface using a web browser.

Smart Inverter Screen

The Smart Inverter Screen enables you to view the status display and to display the current power and consumption on the user interface login page. This gives you an overview of the most important product data without having to log into the user interface.

The Smart Inverter Screen is deactivated by default. The Smart Inverter Screen can be activated via the user interface once the product has been commissioned.

SMA PUK2.0

SMA PUK2.0 replaces for products with firmware version $\geq 4.00.00.R$ the previous procedure for logging in to the user interface if you have forgotten the password for your product. Whether your product supports PUK2.0 is shown on the login page of the user interface via the information button.

To improve security for your product, you can generate a product key. If the password is forgotten, the product can be directly unlocked with the product key on the login page of the user interface. A chargeable order of a PUK from SMA Solar Technology AG is no longer required for products with a firmware version $\geq 4.00.00.R$. If you have lost the product key, you can generate a new one by physically accessing the product.

Diagnostic function

The inverter has a diagnostic function for measuring the current/voltage characteristic curve (I-V characteristic curve) of the PV modules connected to DC inputs. The measurement results can be visualized both as an I-V characteristic curve and as a power/voltage characteristic curve (P-V characteristic curve). The characteristic curve shows deviations and changes from the ideal curve. By this, problems in the PV modules can be detected at an early stage.

SMA Speedwire

The product is equipped with SMA Speedwire as standard. SMA Speedwire is a type of communication based on the Ethernet standard. SMA Speedwire is designed for a data transfer rate of 100 Mbps and enables optimum communication between Speedwire devices within systems.

The products supports the encrypted system communication with SMA Speedwire Encrypted Communication. In order to be able to use the Speedwire encryption in the system, all Speedwire devices, except for the SMA Energy Meter, must support the function SMA Speedwire Encrypted Communication.

SMA Webconnect

The product is equipped with a Webconnect function as standard. The Webconnect function enables direct data transmission between the product and Internet portals Sunny Portal and Sunny Places without any additional communication device and for a maximum of 4 products per visualized system. In PV systems with more than 4 products, there is the option of establishing data

transmission between the products and Sunny Portal via the data logger (e.g., SMA Data Manager) or distributing the inverters over several systems. If there is an existing Wi-Fi or Ethernet connection, you can directly access your visualized system via the web browser on your smart device (e.g. smartphone, tablet or laptop).

Webconnect enables - for PV systems operated in Italy - the connection or disconnection of the inverter to or from the utility grid and the specifying of the frequency limits to be used via IEC61850-GOOSE messages.

WLAN connection to SMA 360° app

There is a QR code on the product by default. If the product is equipped with a Wi-Fi interface, you can access the product via Wi-Fi by scanning the QR code on the product using the SMA 360° or SMA Energy app. This automatically connects to the user interface.

Wi-Fi

Depending on availability, the product is or is not equipped with a Wi-Fi interface. If the Wi-Fi interface is present, the Wi-Fi interface is enabled by default at delivery. If you do not want to use WLAN, you can deactivate the WLAN interface.

If the Wi-Fi interface is present, the product also has a WPS function. The WPS function is for automatically connecting the product to a network (e.g. via router) and establish a direct connection between the product and a smart end device.

Modbus

The product is equipped with a Modbus interface. The Modbus interface is deactivated by default and must be configured as needed.

The Modbus interface of the supported SMA products is designed for industrial use – via SCADA systems, for example – and has the following tasks:

- Remote query of measured values
- Remote setting of operating parameters
- Setpoint specifications for system control

RS485 Interface

The inverter is equipped with an RS485 interface as standard. The inverter can communicate via cables with SMA communication products via the RS485 interface (information on supported SMA products at www.SMA-Solar.com).

Grid management services

The product is equipped with service functions for grid management.

Depending on the requirements of the grid operator, you can activate and configure the functions (e.g. active power limitation) via operating parameters.

Parallel Operation of the DC Inputs A and B

You have the option of operating the inverter DC inputs A and B in parallel. As a result, and as opposed to normal operation, several parallel-connected strings can be connected to the inverter. The inverter automatically detects the parallel operation of the DC inputs A and B.

If you would like to use the arc-fault circuit interrupter SMA ArcFix, both DC inputs A and B must not be operated in parallel.

SMA ShadeFix

The inverter is equipped with the shade management system SMA ShadeFix. SMA ShadeFix uses an intelligent MPP tracking system to determine the operating point with the highest output during shading conditions. With SMA ShadeFix, inverters use the best possible energy supply from the PV modules at all times to increase yields in shaded systems. SMA ShadeFix is enabled by default. The time interval of SMA ShadeFix is usually 6 minutes. This means that the inverter determines the optimum operating point every 6 minutes. Depending on the PV system or shading situation, it may be useful to adjust the time interval.

All-pole sensitive residual-current monitoring unit

The all-pole sensitive residual-current monitoring unit detects alternating and direct differential currents. In single-phase and three-phase inverters, the integrated differential current sensor detects the current difference between the neutral conductor and the line conductor(s). If the current difference increases suddenly, the inverter disconnects from the utility grid.

SMA ArcFix

SMA ArcFix is an Arc Fault Circuit Interrupter (AFCI). With this function, the inverter effectively detects arcs on the DC side and interrupts them. The requirement for this is that both DC inputs A and B are not operated in parallel.

SMA ArcFix can detect electric arcs in the PV modules and the module wiring of connected strings. The arc-fault circuit interrupter is disabled by default and can be enabled if needed. The arc-fault circuit interrupter ensures that the inverter interrupts any electric arcs as soon as they are detected. If the event 4301 is displayed, the system should be monitored closely and recurring faults in the arc-fault circuit interrupter should be investigated immediately by qualified persons. If it is not possible to identify the cause of the error, the inverter should be taken out of operation until the investigation and corrective action can be completed. Recurring errors may cause damage to neighboring conductors and system components, which could result in more extensive system failures and damage and even to uncontrolled electric arcs and fires.

SMA ArcFix complies with the requirements of the IEC 63027 and corresponds to the following installation classes:

- F-I-AFPE-1-2-2
- F-I-AFPE-2-1-2

SMA Smart Connected

SMA Smart Connected is the free monitoring of the product via the SMA Sunny Portal. Thanks to SMA Smart Connected, the operator and qualified person will be informed automatically and proactively about product events that occur.

SMA Smart Connected is activated during registration in Sunny Portal. In order to use SMA Smart Connected, it is necessary that the product is permanently connected to Sunny Portal and the data of the operator and qualified person is stored in Sunny Portal and up-to-date.

4.4 LED Signals

The LEDs indicate the operating state of the product.

LED signal	Explanation
Green LED and red LED flash simultaneously (2 s on and 2 s off)	No country data set set Operation of the product is stopped because no country data set is set. Once the configuration has been completed (for instance using the installation assistant or via a communication product), the product will start operation automatically.
The green LED is flashing (two seconds on and two seconds off)	Waiting for feed-in conditions The conditions for feed-in operation are not yet met. As soon as the conditions are met, the inverter will start feed-in operation.
The green LED flashes quickly	Update of central processing unit The central processing unit of the inverter is being updated.
The green LED is glowing	Feed-in operation The inverter feeds in with a power of at least 90%.
The green LED is pulsing	Feed-in operation The inverter is equipped with a dynamic power display via the green LED. Depending on the power, the green LED pulses fast or slow. If necessary, you can switch off the dynamic power display via the green LED.
The green LED is off	The inverter is not feeding into the utility grid.
The red LED is glowing	Event occurred If an event occurs, a distinct event message and the corresponding event number will be displayed in addition on the product user interface or in the communication product (e.g. SMA Data Manager).
The blue LED flashes slowly for approx. 1 minute	Communication connection is being established The product is establishing a connection to a local network or is establishing a direct connection to a smart device via Ethernet (e.g. smartphone, tablet or laptop).

LED signal	Explanation
The blue LED flashes quickly for approx. two minutes (0.25 s on and 0.25 s off).	WPS active The WPS function is active.
The blue LED is glowing	Communication active There is an active connection with a local network or there is a direct connection via Ethernet with a smart end device (e.g. smartphone, tablet or laptop).

4.5 System Overview

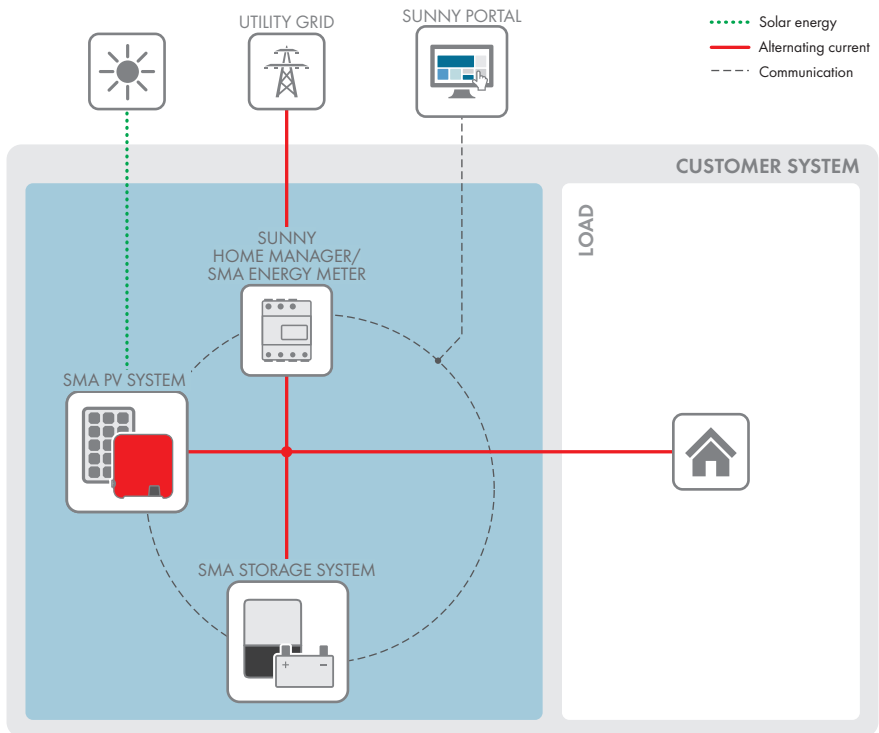

Figure 3: System design

4.5.1 Circuitry Overview

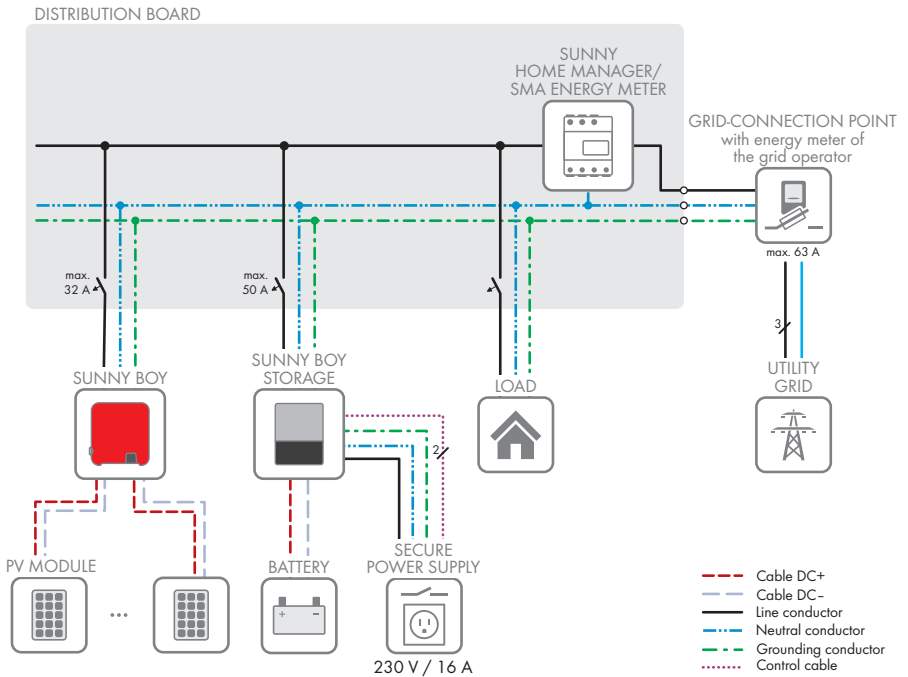

Figure 4: Circuitry overview (example)

4.5.2 Communication Overview

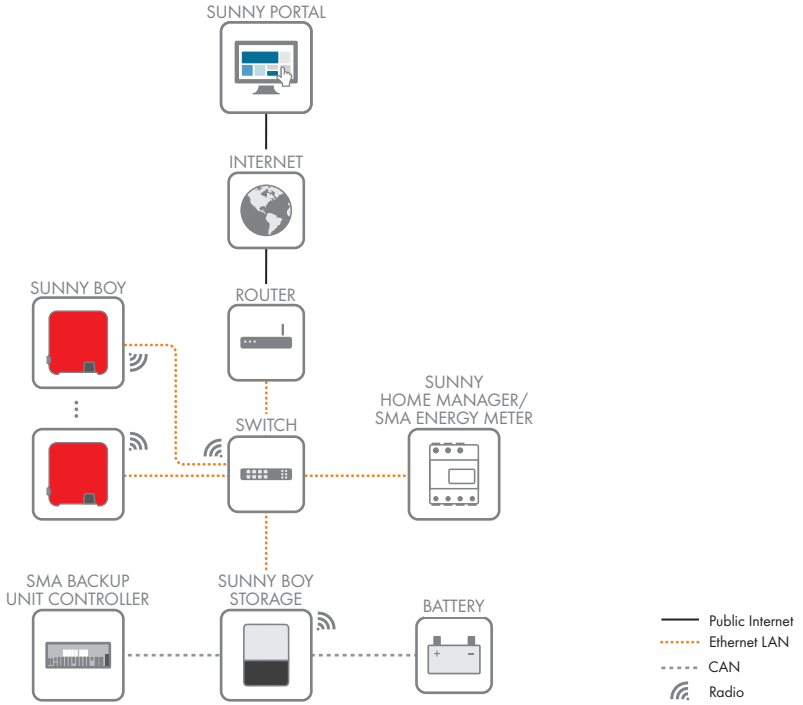

Figure 5: Design of system communication

5 Mounting

5.1 Requirements for Mounting

Requirements for the mounting location:

⚠ WARNING

Danger to life due to fire or explosion

Despite careful construction, electrical devices can cause fires. This can result in death or serious injury.

- Do not mount the product in areas containing highly flammable materials or gases.
 - Do not mount the product in potentially explosive atmospheres.
- A solid support surface must be available (e.g., concrete or masonry). When mounted on drywall or similar materials, the product emits audible vibrations during operation which could be perceived as annoying.
 - The mounting location must be inaccessible to children.
 - The installation site must be suitable for the weight and dimensions of the product (see Section 13, page 112).
 - The installation site must not be exposed to direct solar irradiation. If the product is exposed to direct solar irradiation, the exterior plastic parts might age prematurely and overheating might occur. When becoming too hot, the product reduces its power output to avoid overheating.
 - The installation site should be freely and safely accessible at all times without the need for any auxiliary equipment (such as scaffolding or lifting platforms). Non-fulfillment of these criteria may restrict servicing.
 - The DC load-break switch of the product must always be freely accessible.
 - All ambient conditions must be met (see Section 13, page 112).
 - To ensure optimum operation, the ambient temperature should be between -25°C and $+40^{\circ}\text{C}$.

Permitted and prohibited mounting positions:

- The product may only be mounted in a permitted position. This will ensure that no moisture can penetrate the product.
- The product should be mounted such that the LED signals can be read off without difficulty.

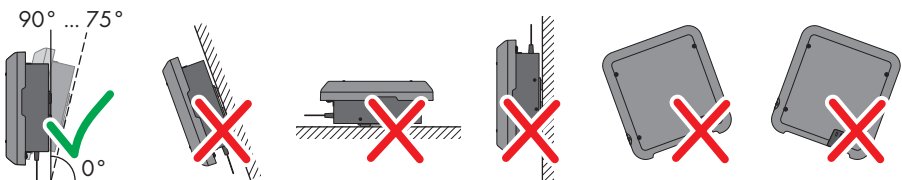

Figure 6: Permitted and prohibited mounting positions

Dimensions for mounting:

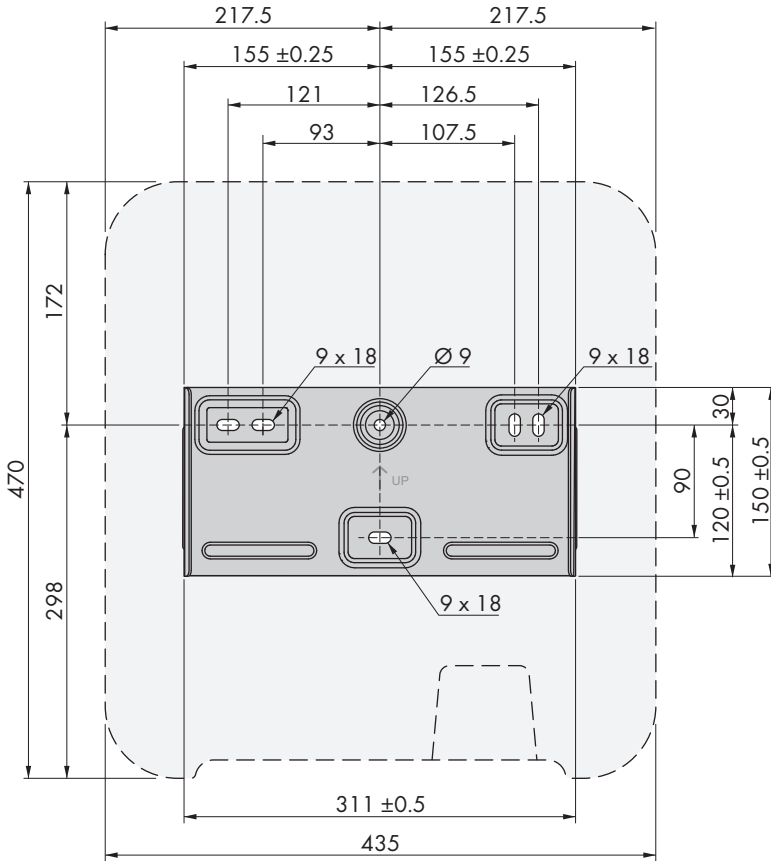

Figure 7: Position of the anchoring points(Dimensions in mm)

Recommended clearances:

If you maintain the recommended clearances, adequate heat dissipation will be ensured. Thus, you will prevent power reduction due to excessive temperature.

- Maintain the recommended clearances to walls as well as to other inverters or objects.
- If multiple products are mounted in areas with high ambient temperatures, increase the clearances between the products and ensure sufficient fresh-air supply.

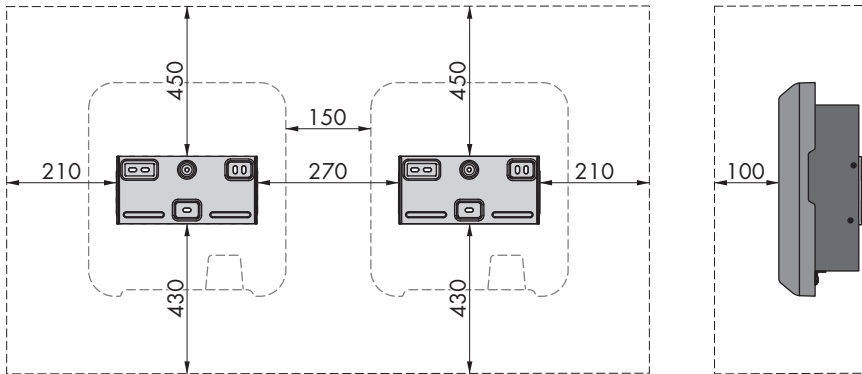

Figure 8: Recommended clearances (Dimensions in mm)

5.2 Mounting the product

Additionally required mounting material (not included in the scope of delivery):

- 3 screws, suitable for the support surface and the weight of the inverter (diameter: minimum 6 mm)
- 3 washers, suitable for the screws (outer diameter: minimum 18 mm)
- Where necessary, 3 screw anchors suitable for the support surface and the screws

⚠ CAUTION

Risk of injury due to weight of product

Injuries may result if the product is lifted incorrectly or dropped while being transported or mounted.

- Transport and lift the product carefully. Take the weight of the product into account.
- Wear suitable personal protective equipment for all work on the product.

Procedure:

1. Align the wall mounting bracket horizontally on the wall and mark the position of the drill holes. Use at least one hole on the right- and left-hand side and the lower hole in the middle of the wall mounting bracket. Tip: When mounting on a post, use the upper and lower central holes of the wall mounting bracket.

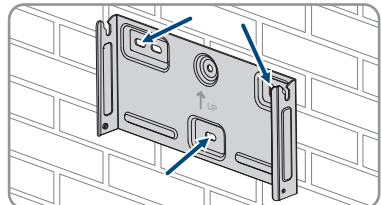

2. Set the wall mounting bracket aside and drill the marked holes.
3. Insert screw anchors into the drill holes if the support surface requires them.

4. Secure the wall mounting bracket horizontally using screws and washers.

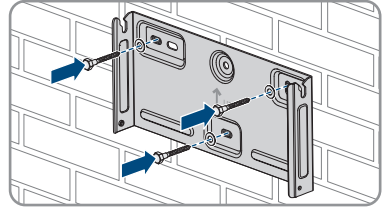

5. Hook the inverter into the wall mounting bracket. When doing so, the two right- and left-hand keys on the ribs on the rear side of the inverter must be hooked into the respective keyways in the wall mounting bracket.

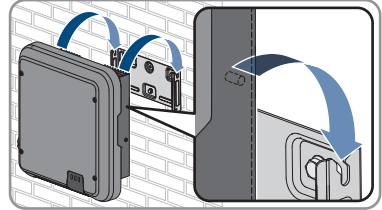

6. Ensure that the inverter is securely in place.
7. Secure the inverter to the wall mounting bracket on both sides with a pan head screw (M5x12) provided. Insert a screw into the lower screw hole of the inverter's anchorage bracket and tighten it (TX25, torque: 2.5 Nm).

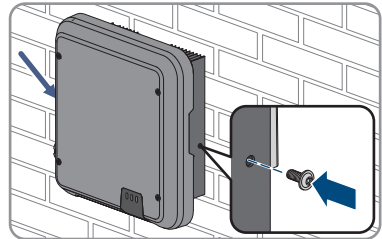

6 Electrical Connection

6.1 Overview of the Connection Area

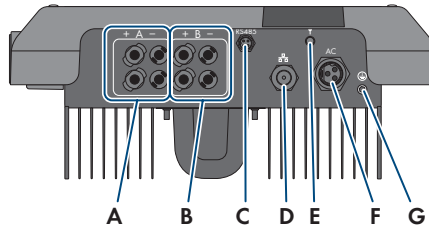

Figure 9: Connection areas at the bottom of the inverter

Position	Designation
A	2 positive and 2 negative DC connectors, input A
B	2 positive and 2 negative DC connectors, input B
C	Jack with protective cap for RS485 communication connection
D	Network port with protective cap
E	Jack with protective cap for the WLAN antenna
F	Jack for the AC connection
G	Connection point for an additional grounding

6.2 AC Connection

6.2.1 Requirements for the AC Connection

AC cable requirements as follows:

- Conductor type: copper wire
- External diameter: 8 mm to 21 mm
- Conductor cross-section: 1.5 mm² to 6 mm²
- Insulation stripping length: 12 mm
- Sheath stripping length: 50 mm
- The cable must be dimensioned in accordance with the local and national directives for the dimensioning of cables. The requirements for the minimum wire size derive from these directives. Examples of factors influencing cable dimensioning are: nominal AC current, type of cable, routing method, cable bundling, ambient temperature and maximum desired line losses (for calculation of line losses, see the design software "Sunny Design" from software version 2.0 at www.SMA-Solar.com).

Grounding cable requirements:**i Use of fine-stranded conductors**

You can use an inflexible or a flexible, fine-stranded conductor.

- When using a fine-stranded conductor, it has to be double crimped by a ring terminal lug. Make sure that no insulated conductor is visible when pulling or bending. This will ensure sufficient strain relief by means of the ring terminal lug.

Grounding cable cross-section: max. 10 mm²

Load-break switch and cable protection:**NOTICE****Damage to the inverter due to the use of screw-type fuses as load-break switches**

Screw-type fuses (e.g. DIAZED fuse or NEOZED fuse) are not load-break switches.

- Do not use screw-type fuses as load-break switches.
- Use a load-break switch or circuit breaker as a load disconnection unit (for information and design examples, see the Technical Information "Miniature circuit breaker" at www.SMA-Solar.com).

- In PV systems with multiple inverters, protect each inverter with a separate circuit breaker. Make sure to observe the maximum permissible fuse protection (see Section 13, page 112). This will prevent residual voltage from being present at the corresponding cable after disconnection.
- Loads installed between the inverter and the circuit breaker must be fused separately.

Residual-current monitoring unit:

The inverter does not require an external residual-current device when operating. If local regulations require the use of a residual-current device, the following must be observed:

- The inverter with firmware version 3.00.10.R is compatible with type A/B residual-current devices that have a rated residual current of 30 mA or higher (information about the selection of a residual-current device see technical information "Criteria for Selecting a Residual-Current Device" at www.SMA-Solar.com). Each inverter in the system must be connected to the utility grid via a separate residual-current device.
- When using residual-current devices with a rated residual current of 30 mA, the rated residual current must be set in the inverter (see Section 8.20, page 73). In this way the inverter reduces the operational leakage currents and prevents a false triggering of the residual-current device.

Overvoltage category:

The product can be used in grids of overvoltage category III or lower in accordance with IEC 60664-1. That means that the product can be permanently connected to the grid-connection point of a building. In case of installations with long outdoor cabling routes, additional measures to reduce overvoltage category IV to overvoltage category III are required (see the Technical Information "Overvoltage Protection" at www.SMA-Solar.com).

Grounding conductor monitoring:

The inverter is equipped with a grounding conductor monitoring device. This grounding conductor monitoring device detects when there is no grounding conductor connected and disconnects the inverter from the utility grid if this is the case. Depending on the installation site and grid configuration, it may be advisable to disable the grounding conductor monitoring. This can be necessary, for example, in a Delta IT system or other grid configurations if there is no neutral conductor present and you intend to install the inverter between two line conductors. If you are uncertain about this, contact your grid operator or SMA Solar Technology AG.

- Grounding conductor monitoring must be disabled after initial start-up depending on the grid configuration (see Section 8.17, page 71).

i **Safety in accordance with IEC 62109 when the grounding conductor monitoring is deactivated**

In order to guarantee safety in accordance with IEC 62109 when the grounding conductor monitoring is deactivated, you have to connect an additional grounding conductor to the inverter.

- Connect an additional grounding conductor that has a cross-section of at least 10 mm (see Section 6.2.3, page 35). This prevents touch current in the event of the grounding conductor on the AC connector bush insert failing.

i **Connection of an additional grounding conductor**

In some countries, an additional grounding conductor is generally required. In each case, observe the locally applicable regulations.

- If an additional grounding conductor is required, connect the one that has a cross-section of at least 10 mm (see Section 6.2.3, page 35). This prevents touch current in the event of the grounding conductor on the AC connector bush insert failing.

6.2.2 Connecting the Inverter to the Utility Grid

⚠ QUALIFIED PERSON

Requirements:

- The connection requirements of the grid operator must be met.
- The grid voltage must be within the permissible range. The exact operating range of the inverter is specified in the operating parameters.

Procedure:

1. Disconnect the AC miniature circuit breaker and secure against reconnection.

2. Ensure that the DC load-break switch is in the **O** position.

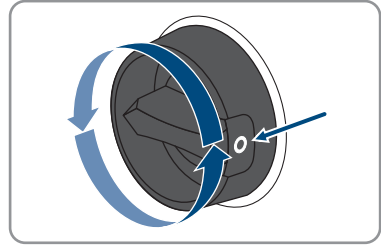

3. If your country requires the DC load-break switch to be protected against reconnection, secure the DC load-break switch against reconnection with a padlock.

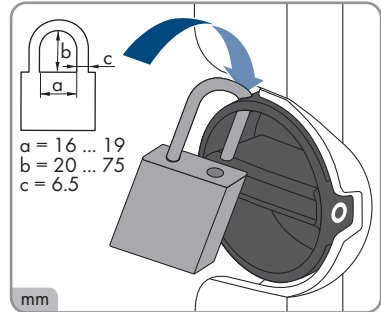

4. Dismantle the AC cable by 50 mm.
5. Shorten L and N by 8 mm each, so that the grounding conductor is 8 mm longer. This ensures that the grounding conductor is the last to be pulled from the screw terminal in the event of tensile strain.
6. Strip the insulation of L, N and the grounding conductor 12 mm.
7. If the conductor cross-section is 1.5 mm^2 to 2.5 mm^2 , provide each conductor with a bootlace ferrule in accordance with DIN 46228.
8. Assemble the AC connector and connect the conductor to the AC connector (see manual of the AC connector).
9. Ensure that all conductors are securely connected to the AC connector.
10. Plug the AC connector into the jack for the AC connection. When doing so, align the AC connector so that the key on the inverter AC jack is inserted into the keyway on the AC connector bush insert.

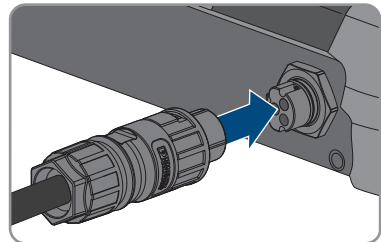

6.2.3 Connecting Additional Grounding

⚠ QUALIFIED PERSON

If additional grounding or equipotential bonding is required locally, you can connect additional grounding to the inverter. This prevents touch current if the grounding conductor on the AC connector fails. The necessary ring terminal lug and the screw are included in the scope of delivery of the inverter.

Additionally required material (not included in the scope of delivery):

- 1 grounding cable
- 1 ring terminal lug

Grounding cable requirements:

i Use of fine-stranded conductors

You can use an inflexible or a flexible, fine-stranded conductor.

- When using a fine-stranded conductor, it has to be double crimped by a ring terminal lug. Make sure that no insulated conductor is visible when pulling or bending. This will ensure sufficient strain relief by means of the ring terminal lug.

- Grounding cable cross-section: max. 10 mm²

Procedure:

1. Strip the grounding cable insulation.
2. Insert the stripped part of the grounding cable into the ring terminal lug and crimp using a crimping tool.

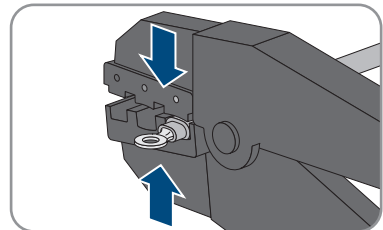

3. Insert the pan head screw M5x12 into the screw hole in the ring terminal lug and screw the ring terminal lug with screw firmly onto the connection point for additional grounding using a Torx screwdriver (TX 25, tightening torque: 2.5 Nm).

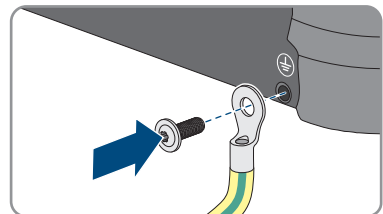

6.2.4 Equipotential Bonding

If components are used in the PV system that require equipotential bonding (e.g. mounting rack, module frame, etc.), these must be connected with a grounding busbar intended for this purpose.

Observe the installation guidelines and regulations applicable in your country. The enclosure of the inverter is not suitable as equipotential bonding. Improper implementation of the equipotential bonding can lead to a product defect that is not covered by the warranty.

6.3 Connecting the Network Cables

QUALIFIED PERSON

DANGER

Danger to life due to electric shock in case of overvoltages and if surge protection is missing

Overvoltages (e.g., in the event of a flash of lightning) can be further conducted into the building and to other connected devices in the same network via the network cables or other data cables if there is no surge protection. Touching live parts and cables results in death or lethal injuries due to electric shock.

- Ensure that all devices in the same network are integrated in the existing overvoltage protection.
- When laying the network cable outdoors, ensure that there is suitable surge protection at the network cable transition from the product outdoors to the network inside the building.
- The Ethernet interface of the product is classified as "TNV-1" and offers protection against overvoltages of up to 1.5 kV.

NOTICE

Product damage due to moisture penetration

Moisture penetration can damage the product and impair its functionality of the product.

- Connect the network cable with the supplied RJ45 protective sleeve to the product.

Additionally required material (not included in the scope of delivery):

- 1 network cable

Network cable requirements:

The cable length and quality affect the quality of the signal. Observe the following cable requirements:

- Cable type: 100BaseTx
- Cable category: minimum CAT5e
- Plug type: RJ45 of Cat5, Cat5e or higher
- Shielding: SF/UTP, S/UTP, SF/FTP or S/FTP
- Number of insulated conductor pairs and insulated conductor cross-section: at least 2 x 2 x 0.22 mm²
- Maximum cable length between 2 nodes when using patch cables: 50 m
- Maximum cable length between 2 nodes when using installation cables: 100 m
- UV-resistant for outdoor use.

Procedure:

1. Disconnect the product from voltage sources (see Section 9, page 77).
2. Unscrew the protective cap from the network port.

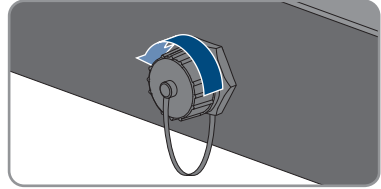

3. Press the cable support sleeve out of the threaded sleeve.
4. Feed the network cable through the swivel nut and threaded sleeve. Attach the cable support sleeve to the network cable.

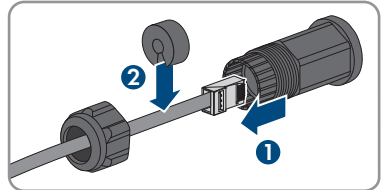

5. Press the cable support sleeve into the threaded sleeve.
6. Insert the network plug of cable into the product's network port. Ensure that the cable is correctly locked in place. Turn the threaded sleeve onto the thread of the network port on the product.

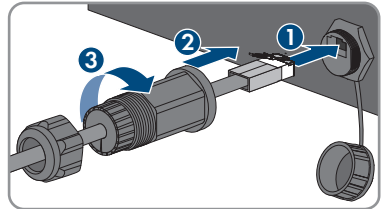

7. Screw the swivel nut onto the threaded sleeve.

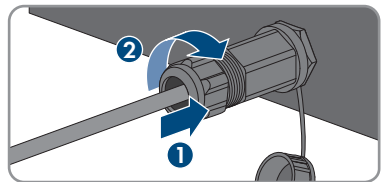

8. If you would like to establish a direct connection, connect the other end of the network cable directly to the end device.
9. If you would like to integrate the product into a local network, connect the other end of the network cable to the local network (e.g. via a router).

6.4 Connecting RS485 Devices

⚠ QUALIFIED PERSON

Additionally required material (not included in the scope of delivery):

- One communication cable for RS485 communication
- One M12 plug, 4-pole

Signal assignment:

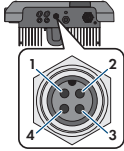
	Pin connector	Signal	Sunny Web-Box	Sunny Boy Control	<input checked="" type="checkbox"/> Insulated conductor color
	1	GND	5	5	
	2	+12 V	-	-	
	3	Data-	7	8	
	4	Data+	2	3	

RS485 configuration:

In the installation assistant, the application **SMA Data** must be selected for communication via RS485 between the product and other SMA products. In addition, depending on the position of the product in the RS485 communication bus, the terminating resistor must be activated.

Procedure:

1.

⚠ DANGER

Danger to life due to electric shock

- Disconnect the inverter from all voltage sources (see Section 9, page 77).

2. Assemble the M12 plug and connect the RS485 cable to the plug (see manual of the M12 connector).
3. Ensure that all conductors are correctly connected to the M12 plug.
4. Unscrew the protective cap from the jack for the RS485 communication connection.

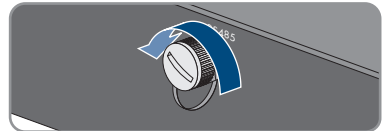

5. Plug the M12 connector into the jack for the RS485 communication connection and screw tight. When doing so, align the connector so that the key on the inverter AC jack is inserted into the keyway on the plug.

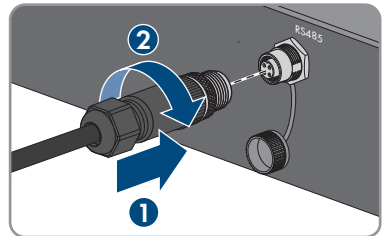

6.5 Mounting the WLAN Antenna

⚠ QUALIFIED PERSON

If the inverter is equipped with a Wi-Fi interface, the Wi-Fi antenna must be installed.

Requirement:

- The Wi-Fi antenna supplied must be used.

Procedure:

1. Disconnect the product from voltage sources (see Section 9, page 77).
2. Remove the protective cap from the jack on the inverter.
3. Plug the Wi-Fi antenna into the jack and screw tight (torque: 1 Nm).

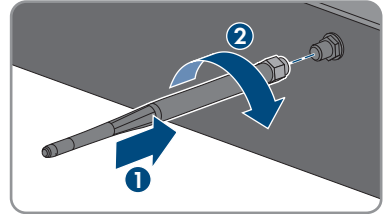

4. Pull on the Wi-Fi antenna to ensure that the Wi-Fi antenna is securely in place.

6.6 DC connection

6.6.1 Requirements for the DC Connection

Connection options:

The inverter has two DC inputs, to each of which one string can be connected in normal operation. You have the option of operating the DC inputs A and B in parallel, and therefore of connecting several strings to the inverter.

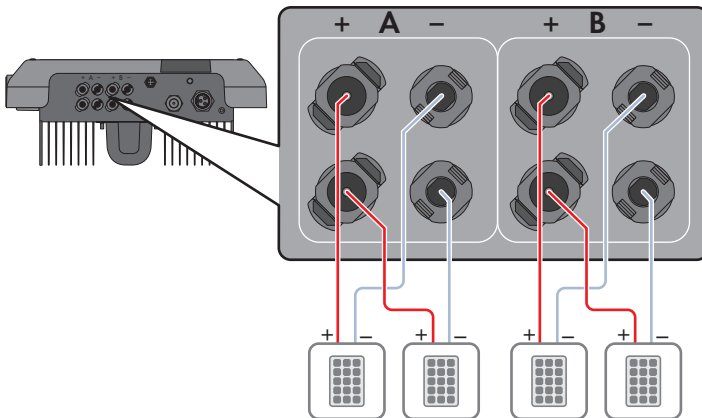

Figure 10: Connection overview for normal operation

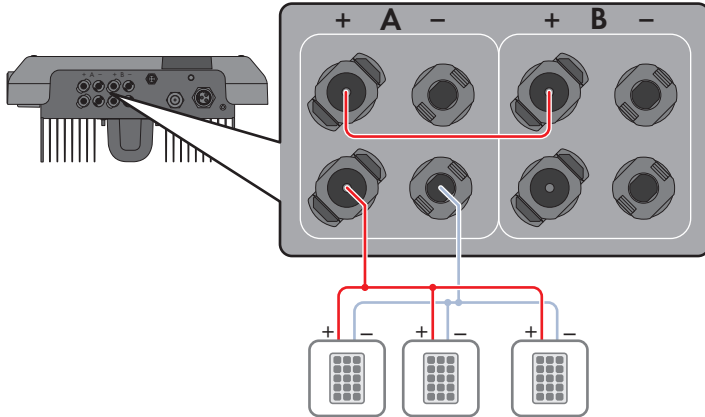

Figure 11: Connection overview for parallel connection of the DC inputs A and B

Requirements for the PV modules per input:

- All PV modules should be of the same type.
- All PV modules should be aligned and tilted identically.
- On the coldest day based on statistical records, the open-circuit voltage of the PV array must never exceed the maximum input voltage of the inverter.
- The same number of series-connected PV modules must be connected to each string.
- The maximum input current per string must be maintained and must not exceed the through-fault current of the DC connectors (see Section 13, page 112).
- The thresholds for the input voltage and the input current of the inverter must be adhered to (see Section 13, page 112).
- The positive connection cables of the PV modules must be equipped with positive DC connectors (see Section 6.6.2, page 41).
- The negative connection cables of the PV modules must be equipped with the negative DC connectors (see Section 6.6.2, page 41).

i Use of Y adapters for parallel connection of strings

The Y adapters must not be used to interrupt the DC circuit.

- Do not use the Y adapters in the immediate vicinity of the inverter. The adapters must not be visible or freely accessible.
- In order to interrupt the DC circuit, always disconnect the inverter as described in this document (see Section 9, page 77).

6.6.2 Assembling the DC Connectors

⚠ QUALIFIED PERSON

⚠ DANGER

Danger to life due to electric shock when live components or DC cables are touched

When exposed to light, the PV modules generate high DC voltage which is present in the DC cables. Touching live DC cables results in death or lethal injuries due to electric shock.

- Do not touch non-insulated parts or cables.
- Disconnect the product from voltage sources and ensure it cannot be reconnected before working on the device.
- Wear suitable personal protective equipment for all work on the product.

NOTICE

Destruction of the inverter due to overvoltage

If the open-circuit voltage of the PV modules exceeds the maximum input voltage of the inverter, the inverter can be destroyed due to overvoltage.

- If the open-circuit voltage of the PV modules exceeds the maximum input voltage of the inverter, do not connect any strings to the inverter and check the design of the PV system.

For connection to the inverter, all PV module connection cables must be fitted with the DC connectors provided. Assemble the DC connectors as described in the following. The procedure is identical for both connectors (+ and -). The graphics for the procedure are shown for only the positive connector as an example. Pay attention to the correct polarity when assembling the DC connectors. The DC connectors are marked with the symbols "+" and "-".

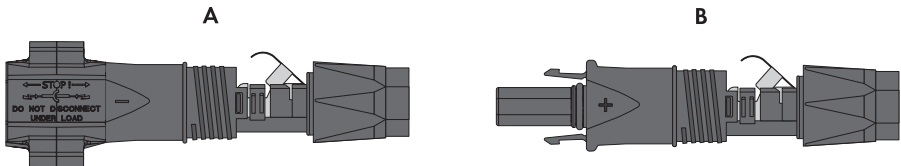

Figure 12: Negative (A) and positive (B) DC connectors

Cable requirements:

- External diameter: 5.5 mm to 8 mm
- Conductor cross-section: 2.5 mm² to 6 mm²
- Qty single wires: minimum 7
- Nominal voltage: minimum 1000 V
- Using bootlace ferrules is not allowed.

Procedure:

1. Strip approx. 15 mm of the cable insulation.

2. Insert the stripped cable into the DC connector up to the stop. When doing so, ensure that the stripped cable and the DC connector are of the same polarity.

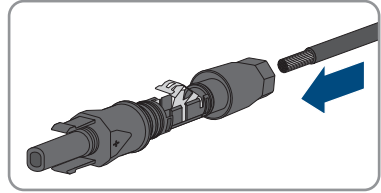

3. Press the clamping bracket down until it audibly snaps into place.

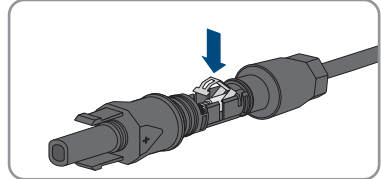

- ☑ The stranded wire can be seen inside the clamping bracket chamber.

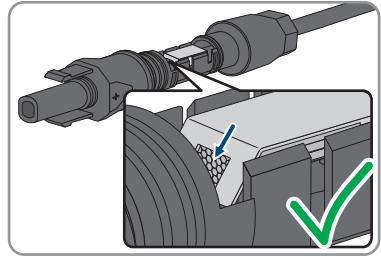

4. If the stranded wire is not visible in the chamber, the cable is not correctly inserted and the connector must be reassembled. To do this, the cable must be removed from the connector.
5. To take out the cable, loosen the clamping bracket. To do so, insert a screwdriver (blade width: 3.5 mm) into the clamping bracket and pry the clamping bracket open.

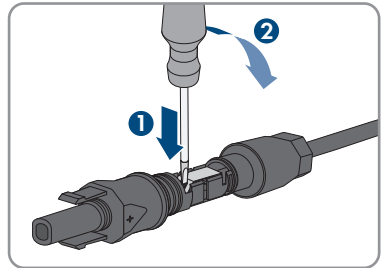

6. Remove the cable and go back to step 2.
7. Push the swivel nut up to the thread and tighten (torque: 2 Nm).

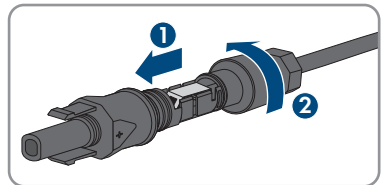

6.6.3 Connecting the PV Array

QUALIFIED PERSON

WARNING

Danger to life due to electric shock from destruction of the measuring device due to overvoltage

Overvoltage can damage a measuring device and result in voltage being present in the enclosure of the measuring device. Touching the live enclosure of the measuring device results in death or lethal injuries due to electric shock.

- Only use measuring devices with a DC input voltage range of 600 V or higher.

NOTICE

Destruction of the inverter due to overvoltage

If the open-circuit voltage of the PV modules exceeds the maximum input voltage of the inverter, the inverter can be destroyed due to overvoltage.

- If the open-circuit voltage of the PV modules exceeds the maximum input voltage of the inverter, do not connect any strings to the inverter and check the design of the PV system.

NOTICE

Damage to the DC connectors due to the use of contact cleaner of other cleaning agents

Some contact cleaners or other cleaning agents may contain substances that decompose the plastic of the DC connectors.

- Do not use contact cleaners or other cleaning agents for cleaning the DC connectors.

NOTICE

Damage to the product due to ground fault on DC side during operation

Due to the transformerless topology of the product, the occurrence of ground faults on DC side during operation can lead to irreparable damage. Damages to the product due to a faulty or damaged DC installation are not covered by warranty. The product is equipped with a protective device that checks whether a ground fault is present during the starting sequence. The product is not protected during operation.

- Ensure that the DC installation is carried out correctly and no ground fault occurs during operation.

Procedure:

1. Disconnect the AC miniature circuit breaker and secure against reconnection.
2. If an external DC load-break switch is installed, disconnect the external DC load-break switch from all voltage sources.

3. Turn the DC load-break switch of the inverter to position **O**.

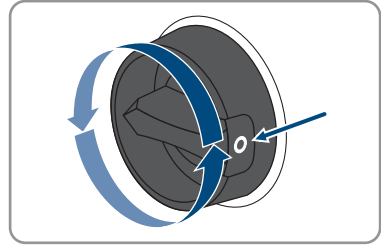

4. If your country requires the DC load-break switch to be protected against reconnection, secure the DC load-break switch against reconnection with a padlock.

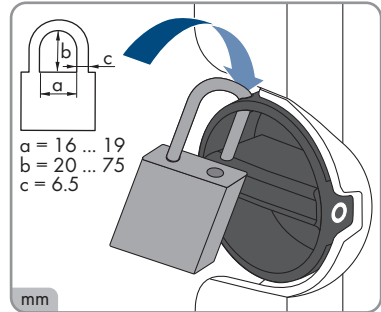

5. Measuring the voltage of the PV array. Ensure that the maximum input voltage of the inverter is adhered to and that there is no ground fault in the PV system.
6. Check whether the DC connectors have the correct polarity.
7. If the DC connector is equipped with a DC cable of the wrong polarity, the DC connector must be reassembled. When this is done, the DC cable must always have the same polarity as the DC connector.
8. Ensure that the whole open-circuit voltage of the PV array does not exceed the maximum input voltage of the inverter.
9. Connect the assembled DC connectors to the inverter.

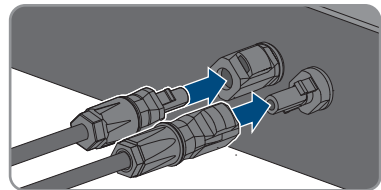

- The DC connectors snap into place.

10. Ensure that all DC connectors are securely in place.

11.

NOTICE**Damage to the product due to sand, dust and moisture ingress if the DC inputs are not closed**

The product is only properly sealed when all unused DC inputs are closed with DC connectors and sealing plugs. Sand, dust and moisture penetration can damage the product and impair its functionality.

- Seal all unused DC inputs using the DC connectors and sealing plugs as described in the following. When doing so, do not plug the sealing plugs directly into the DC inputs on the inverter.

12. For unused DC connectors, push down the clamping bracket and push the swivel nut up to the thread.

13. Insert the sealing plug into the DC plug connector.

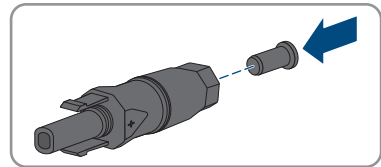

14. Insert the DC connectors with sealing plugs into the corresponding DC inputs on the inverter.

- The DC connectors snap into place.

15. Ensure that the DC connectors with sealing plugs are securely in place.

6.6.4 Disassembling the DC Connectors

⚠ QUALIFIED PERSON

To disassemble the DC connectors for connection to the pv modules (e.g. due to faulty assembly), proceed as follows.

⚠ DANGER

Danger to life due to electric shock when touching exposed DC conductors or DC plug contacts if the DC connectors are damaged or loose

The DC connectors can break or become damaged, become free of the DC cables, or no longer be connected correctly if the DC connectors are released and disconnected incorrectly. This can result in the DC conductors or DC plug contacts being exposed. Touching live DC conductors or DC plug connectors will result in death or serious injury due to electric shock.

- Wear insulated gloves and use insulated tools when working on the DC connectors.
- Ensure that the DC connectors are in perfect condition and that none of the DC conductors or DC plug contacts are exposed.
- Carefully release and remove the DC connectors as described in the following.

Procedure:

1. Release and remove the DC connectors. To do so, insert a flat-blade screwdriver or an angled screwdriver (blade width: 3.5 mm) into one of the side slots and pull the DC connectors out. When doing so, do not lever the DC connectors out, but insert the tool into one of the side slots only to release the locking mechanism, and do not pull on the cable.
2. Remove the DC connector swivel nut.

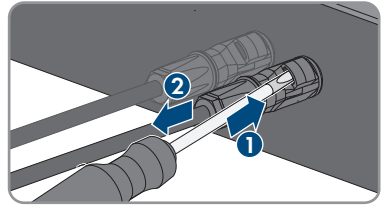

3. Unlock the DC connector. To do this, insert a flat-blade screwdriver (blade width: 3.5 mm) into the side catch mechanism and pry the catch mechanism open.

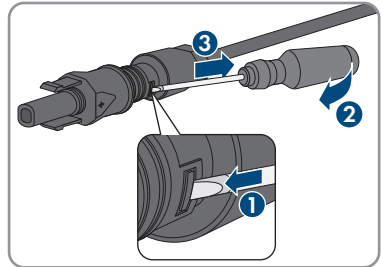
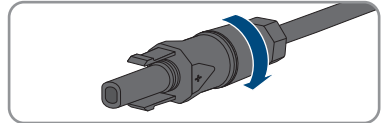

4. Carefully pull the DC connector apart.
5. Release the clamping bracket. To do so, insert a flat-blade screwdriver (blade width: 3.5 mm) into the clamping bracket and pry the clamping bracket open.

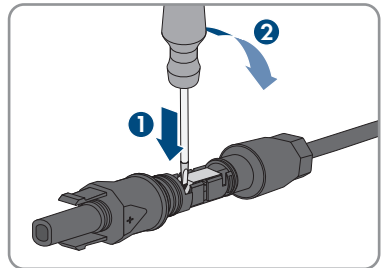

6. Remove the cable.

7 Commissioning

7.1 Commissioning Procedure

⚠ QUALIFIED PERSON

This section describes the commissioning procedure and gives an overview of the steps you must perform in the prescribed order.

i Commissioning a product in SMA Energy Systems

If the product is used in an SMA Energy System, the commissioning must be performed according to the manual of the SMA Energy System. The procedure and the sequence may differ from the steps described in this section.

- Commissioning an SMA Energy System (see system manual of the SMA Energy System).

i Commissioning an inverter that is captured in a communication device

When the inverter is captured in a communication device, the communication device (e.g. SMA Data Manager) is the unit for configuring the total system. The configuration is transferred to all inverters in the system. The system password assigned via the communication device is also the password for the user interface of the inverter.

- Commission the inverter (see Section 7.2, page 48).
- The initial configuration of the inverter is made via the communication device. The configuration is transferred to the inverter and the settings of the inverter are overwritten.
- Deactivate the Webconnect function of the inverter via the Sunny Portal. This prevents unnecessary connection attempts of the inverter with Sunny Portal.

i A country data set must be set for feed-in operation

From firmware version 4.00.00.R, the activation conditions for feed-in operation were changed.

To ensure the inverter begins feed-in operation during initial commissioning, a country data set must be set (for instance via the installation assistant on the user interface of the product, or via a communication product).

If no country data set is set, then feed-in operation will be stopped. This state is signaled by the green and red LEDs flashing simultaneously.

The inverter will automatically start feed-in operation only after the inverter configuration is completed.

Procedure	See
1. Commission the inverter.	Section 7.2, page 48

Procedure	See
2. Establish a connection to the user interface of the inverter. There are various connection options to choose from for this: <ul style="list-style-type: none"> • Direct connection via WLAN • Direct connection via Ethernet • Connection via WLAN in the local network • Connection via Ethernet in the local network 	Section 8.1, page 53
3. Log into the user interface.	Section 8.2, page 57
4. Select the inverter configuration option. Please note that the SMA Grid Guard code for changing the grid-relevant parameters must be available after completion of the first ten feed-in hours or installation assistant. You can request the SMA Grid Guard code via the Online Service Center.	Section 7.3, page 49
5. Configure the product and set country data set. Then the product will begin operation.	Section 8.13, page 68
6. Make further inverter settings as needed.	Section 8, page 53
7. For PV systems in Italy or Dubai: Start the self-test.	Section 7.4, page 51

7.2 Commissioning the Inverter

⚠ QUALIFIED PERSON

Requirements:

- The AC miniature circuit breaker must be correctly rated and mounted.
- The product must be correctly mounted.
- All cables must be correctly connected.

Procedure:

1. If the DC load-break switch has been protected against restarting with a padlock, open and detach the padlock on the DC load-break switch.
2. Turn the DC load-break switch of the inverter to position I.

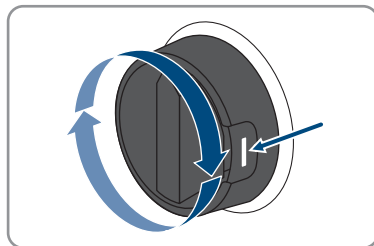

3. Switch on the AC circuit breaker.
 - ☑ All 3 LEDs light up. The start-up phase begins.
 - ☑ During start-up phase of the inverter, the desired firmware is being installed.
 - ☑ All 3 LEDs go out again after approximately 90 seconds.
 - ☑ The green LED starts to flash and, if the inverter is connected via Speedwire, the blue LED also starts to flash.
4. If the green and red LEDs flash simultaneously during initial commissioning, operation is stopped because no country data set has been set yet. For the inverter to begin operation, the configuration must be completed and a country data set must be set.
5. If the green LED is still flashing, the conditions for activating feed-in operation are not yet met. As soon as the conditions for feed-in operation are met, the inverter starts with feed-in operation and, depending on the available power, the green LED will light up continuously or it will pulse.
6. If the red LED lights up, an event has occurred. Find out which event has occurred and, if necessary, initiate countermeasures.

7.3 Selecting a configuration option

⚠ QUALIFIED PERSON

After you have assigned the password for the user groups **Installer** and **User** and have logged in as **Installer**, the **Configuring the Inverter** page opens.

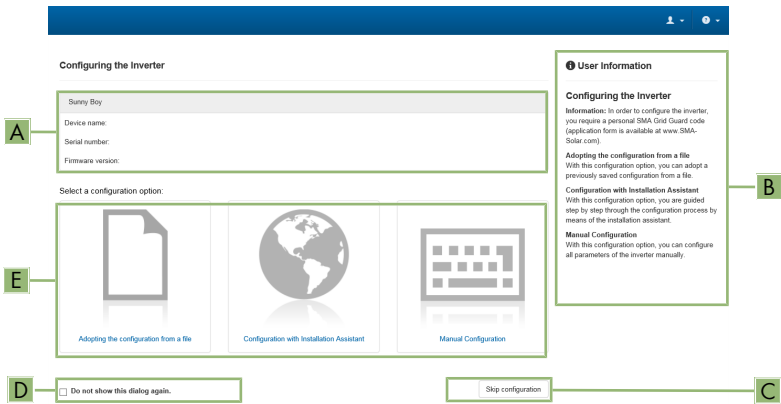

Figure 13: Layout of the **Configuring the Inverter** page

Position	Designation	Description
A	Device information	Provides the following information: <ul style="list-style-type: none"> • Device name • Inverter serial number • Inverter firmware version

Position	Designation	Description
B	User information	Provides brief information on the listed configuration options
C	Skip configuration	Offers the option of skipping the inverter configuration and go directly to the user interface (not recommended)
D	Checkbox	Allows you to choose not to have the displayed page displayed again when the user interface is called up again
E	Configuration options	Provides a selection of the various configuration options

Configuration options:

On the **Configuring the Inverter** page, different configuration options are available to choose from. Select one of the options and proceed for the selected option as described below. SMA Solar Technology AG recommends carrying out the configuration with the installation assistant. This way, you ensure that all relevant parameters are set for optimal inverter operation.

- Adoption of configuration from a file
- Configuration with the installation assistant (recommended)
- Manual configuration

Accepting the settings

Saving the made settings is indicated by an hourglass symbol on the user interface. If the DC voltage is sufficient, the data is transferred directly to the inverter and accepted. If the DC voltage is too low (e. g. in the evening), the settings are saved, but they cannot be directly transferred to or accepted by the inverter. As long as the inverter has not yet received and accepted the settings, the hourglass symbol will continue to be displayed on the user interface. The settings will be accepted when there is sufficient DC voltage applied and the inverter restarts. As soon as the hourglass symbol appears on the user interface, the settings have been saved. The settings will not be lost. You can log off of the user interface and leave the system.

Adopt the configuration from a file

You can adopt the inverter configuration from a file. To do this, there must be an inverter configuration saved to a file.

Procedure:

1. Select the configuration option **Adopt the configuration from a file**.
2. Select [**Browse...**] and select the desired file.
3. Select [**Import file**].

Configuring the Installation Assistant (Recommended)

1. Select the configuration option **Configuration with Installation Assistant**.
 - The installation assistant will open.

2. Follow the installation assistant steps and make the settings appropriate for your system.
3. For every setting made in a step, select [**Save and next**].
 - In the last step, all made settings are listed in a summary.
4. To correct settings you made, select [**Back**], navigate to the desired step, correct settings and select [**Save and continue**].
5. Once all settings are correct, select [**Next**] in the summary.
6. To save the settings to a file, select [**Export a summary**] and save the file on your smart device.
7. To export all parameters and their settings, select [**Export all parameters**]. This exports all parameters and their settings into an HTML file.
 - The start page of the user interface opens.

Manual configuration

You can configure the inverter manually by setting the desired parameters.

Procedure:

1. Select the configuration option **Manual Configuration**.
 - The **Device Parameters** menu on the user interface will open and all available parameter groups of the inverter will be displayed.
2. Select [**Edit parameters**].
3. Select the desired parameter group.
 - All available parameters of the parameter group will be displayed.
4. Set the desired parameters.
5. Select [**Save all**].
 - The inverter parameters are set.

7.4 Starting the Self-Test (for Italy and Dubai)

QUALIFIED PERSON

The self-test is only required for inverters that are to be commissioned in Italy or Dubai. The Italian standard CEI 0-21 and the DEWA (Dubai Electricity and Water Authority) stipulate that all inverters that feed into the utility grid are equipped with a self-test function. During the self-test, the inverter will consecutively check the reaction times for overvoltage, undervoltage, maximum frequency and minimum frequency.

The self-test changes the upper and lower disconnection values for each protective function on a linear basis for frequency monitoring and voltage monitoring. As soon as the measured value exceeds the permitted disconnection threshold, the inverter disconnects from the utility grid. In this way, the inverter determines the reaction time and checks itself.

After the self-test has been completed, the inverter automatically switches back to feed-in operation, resets the original disconnection conditions and connects to the utility grid. The test takes approximately three minutes.

Requirements:

- The country data set of the inverter must be set to **[IT] CEI 0-21 intern** or **[AE] DEWA 2016 intern**.

Procedure:

1. Select the menu **Device Configuration**.
2. Select **[Settings]**.
3. Select **[Starting the Self-Test]** in the subsequent context menu.
4. Follow the instructions appearing in the dialog and save the report of the self-test where necessary.

8 Operation

8.1 Establishing a connection to the user interface

8.1.1 Establishing a Direct Connection via Ethernet

Requirements:

- The product must be commissioned.
- A smart device (e.g. laptop) with an Ethernet interface must be available.
- The product must be connected directly to the smart device.
- The respective latest version of one of the following web browsers must be installed on the smart device: Chrome, Edge, Firefox or Safari.
- The installer's SMA Grid Guard code must be available to change network-relevant settings after the first 10 hours of feed-in operation, or after completing the installation assistant. You can request the SMA Grid Guard code via the Online Service Center.
- JavaScript must be enabled in the web browser of the smart device.

i IP address of the inverter

- Standard inverter IP address for the direct connection via Ethernet: **169.254.12.3**

Procedure:

1. Open the web browser of your smart device and enter the IP address **169.254.12.3** in the address bar.
 2. **i Web browser displays warning**

After the access address of the product has been entered, a message might appear indicating that the connection to the user interface of the product is not secure.

 - Continue loading the user interface (scroll to bottom and click proceed/advance).
- The login page of the user interface opens.

8.1.2 Establishing a direct connection via WLAN

You have several options to connect the product to an end device. The procedure can be different depending on the end devices. If the procedures described do not apply to your end device, establish the direct connection via Wi-Fi as described in the manual of your end device.

The following connection options are available:

- Connection to SMA 360° App
- Connection with WPS
- Connection with Wi-Fi network search

Requirements:

- The product must be commissioned.
- A smart device (e.g. smartphone, tablet or laptop) must be available.

- The respective latest version of one of the following web browsers must be installed on the smart device: Chrome, Edge, Firefox or Safari.
- JavaScript must be enabled in the web browser of the smart device.
- The installer's SMA Grid Guard code must be available to change network-relevant settings after the first 10 hours of feed-in operation, or after completing the installation assistant. You can request the SMA Grid Guard code via the Online Service Center.

i SSID, IP address and WLAN password

- SSID in WiFi: **https://SMA[serial number]** (e.g. **https://SMA0123456789**)
- Device-specific WLAN password: see WPA2-PSK on the type label of the product or the rear side of the manual included in delivery
- Standard access address for a direct connection via WLAN outside of a local network: **http://smalogin.net** or **192.168.12.3**

i Importing and exporting files with smart devices having an iOS operating system is not possible

For technical reasons, importing and exporting files (e.g., importing an inverter configuration, saving the current inverter configuration or exporting events and parameters) is not possible with smart devices having an iOS operating system.

- Use a smart device that does not have an iOS operating system for importing and exporting files.

Connection to SMA 360° App

Requirements:

- A smart device with camera (e.g. smartphone or tablet) must be available.
- The SMA 360° App must be installed on the smart device.
- An user account for Sunny Portal must already exist.

Procedure:

1. Open the SMA 360° App and login with the Sunny Portal account details.
2. Select **QR-Code Scan** in the menu.
3. Scan the QR Code on you product via the SMA 360° App.
 - The smart device automatically connects to the product. The web browser of your smart device opens and the login page of the user interface is displayed.
4. If the web browser of the smart end device does not open automatically and the login page of the user interface is not displayed, open the web browser and enter **https://smalogin.net** in the address bar.

Connection with WPS

Requirements:

- The end device must have a WPS function.

Procedure:

1. Enable the WPS function on the inverter. To do this, tap on the enclosure lid of the inverter twice.
 - The blue LED flashes quickly for approx. two minutes. The WPS function is active during this time.
2. Enable the WPS function on your end device.
 - The smart device automatically connects to the product. The web browser of your smart device opens and the login page of the user interface is displayed.
3. If the web browser of the smart end device does not open automatically and the login page of the user interface is not displayed, open the web browser and enter **https://smalogin.net** in the address bar.

Connection with Wi-Fi network search

1. Search for Wi-Fi networks with your end device.
2. Select the SSID of the product **SMA[serial number]** in the list with the detected Wi-Fi networks.
3. Enter the device-specific Wi-Fi password (see WPA2-PSK on the type label of the product or the rear side of the manual included in delivery).
4. Open the web browser of your smart end device and enter **https://smalogin.net** in the address bar.
 - The login page of the user interface is displayed.
5. If the login page of the user interface does not open, enter the IP address **192.168.12.3** or, if your smart device supports mDNS services, **SMA[serial number].local** or **http://SMA[serial number]** in the address bar of the web browser.

8.1.3 Establishing a Connection via Ethernet in the local network

i New IP address for connecting with a local network

If the product is connected to a local network (e.g. via a router), the product will receive a new IP address. Depending on the type of configuration, the new IP address will be assigned automatically by the DHCP server (router) or manually by you. Upon completion of the configuration, the product can only be reached via the following access addresses:

- Generally applicable access address: IP address manually assigned or assigned by the DHCP server (router) (identification via network scanner software or network configuration of the router).
- Access address for Apple and Linux systems: **https://SMA[serial number].local** (e.g. **https://SMA0123456789.local**)
- Access address for Windows and Android systems: **http://SMA[serial number]** (e.g., **http://SMA0123456789**)

i Communication disturbances in the local network

The IP address range 192.168.12.0 to 192.168.12.255 is occupied for communication amongst SMA products and for direct access to SMA products.

Communication problems might occur if this IP address range is used in the local network.

- Do not use the IP address range 192.168.12.0 to 192.168.12.255 in the local network.

Requirements:

- The product must be connected to the local network via a network cable (e.g. via a router).
- The product must be integrated into the local network. Tip: There are various methods of integrating the product into the local network with the aid of the installation assistant.
- A smart device (e.g. smartphone, tablet or laptop) must be available.
- The smart device must be in the same local network as the product.
- The respective latest version of one of the following web browsers must be installed on the smart device: Chrome, Edge, Firefox or Safari.
- The installer's SMA Grid Guard code must be available to change network-relevant settings after the first 10 hours of feed-in operation, or after completing the installation assistant. You can request the SMA Grid Guard code via the Online Service Center.

Procedure:

1. Open the web browser of your smart device. Enter the IP address of the product in the address bar of the web browser.
 2. **i** **Web browser displays warning**
After the access address of the product has been entered, a message might appear indicating that the connection to the user interface of the product is not secure.
 - Continue loading the user interface (scroll to bottom and click proceed/advance).
- The login page of the user interface opens.

8.1.4 Establishing a Connection via WLAN in the Local Network

i New IP address for connecting with a local network

If the product is connected to a local network (e.g. via a router), the product will receive a new IP address. Depending on the type of configuration, the new IP address will be assigned automatically by the DHCP server (router) or manually by you. Upon completion of the configuration, the product can only be reached via the following access addresses:

- Generally applicable access address: IP address manually assigned or assigned by the DHCP server (router) (identification via network scanner software or network configuration of the router).
- Access address for Apple and Linux systems: **https://SMA[serial number].local** (e.g. **https://SMA0123456789.local**)
- Access address for Windows and Android systems: **http://SMA[serial number]** (e.g., **http://SMA0123456789**)

Requirements:

- The product must be commissioned.
- The product must be integrated into the local network. Tip: There are various methods of integrating the product into the local network with the aid of the installation assistant.
- A smart device (e.g. smartphone, tablet or laptop) must be available.
- The smart device must be in the same local network as the product.
- The respective latest version of one of the following web browsers must be installed on the smart device: Chrome, Edge, Firefox or Safari.
- The installer's SMA Grid Guard code must be available to change network-relevant settings after the first 10 hours of feed-in operation, or after completing the installation assistant. You can request the SMA Grid Guard code via the Online Service Center.

i **Importing and exporting files with smart devices having an iOS operating system is not possible**

For technical reasons, importing and exporting files (e.g., importing an inverter configuration, saving the current inverter configuration or exporting events and parameters) is not possible with smart devices having an iOS operating system.

- Use a smart device that does not have an iOS operating system for importing and exporting files.

Procedure:

- Enter the IP address of the product in the address bar of the web browser.
 - The login page of the user interface opens.

8.2 Logging In and Out of the User Interface

After a connection to the user interface of the inverter has been established, the login page opens. Log onto the user interface as described below.

i **Usage of cookies**

For the correct display of the user interface, cookies are required. The cookies are used for convenience only. By using this user interface you agree to the placement of cookies.

Log in as Installer or User for the First Time

i **Password assignment for user and installer**

The passwords for the user groups **Installer** and **User** must be assigned when accessing the user interface for the first time. If the inverter was registered in a System Manager (e.g. SMA Data Manager) and the system password was assigned, the system password is also the installer password. In this case, only the user password must be assigned.

- If you as a specialist assign the user password, only pass the password on to persons to access the inverter data via the user interface.
- If you as a user assign the installer password, only pass the password on to persons to receive access to the system.

i **Installer password for inverters registered in a System Manager or in Sunny Portal**

To be able to register the inverter in a System Manager (e.g. SMA Data Manager) or in a Sunny Portal system, the password for the user group **Installer** must match the system password. If you assign a password for the user group **Installer** via the user interface of the inverter, the same password must also be used as the system password.

- Assign a uniform installer password to all SMA devices in the system.

Procedure:

1. In the drop-down list **Language**, select the desired language.
 2. In the **Password** field, enter a password for the **User** user group.
 3. In the **Repeat password** field, enter the password again.
 4. Click on **Save**.
 5. In the **New password** field, enter a password for the **Installer** user group. Assign a uniform password to all SMA devices to be registered in a system. The installer password is also the system password.
 6. In the **Repeat password** field, enter the password again.
 7. Click on **Save and log in**.
- The **Configuring the Inverter** page opens.

Log in as the User or Installer

1. In the drop-down list **Language**, select the desired language.
 2. In the **User group** drop-down list, select the entry **Installer** or **User**.
 3. Enter the password in the field **Password**.
 4. Select **Login**.
- The start page of the user interface opens.

Log out as the User or Installer

1. On the right-hand side of the menu bar, select the menu **User Settings**.
 2. In the subsequent context menu, select [**Logout**].
- The login page of the user interface opens. The logout was successful.

8.3 Start Page Design of the User Interface

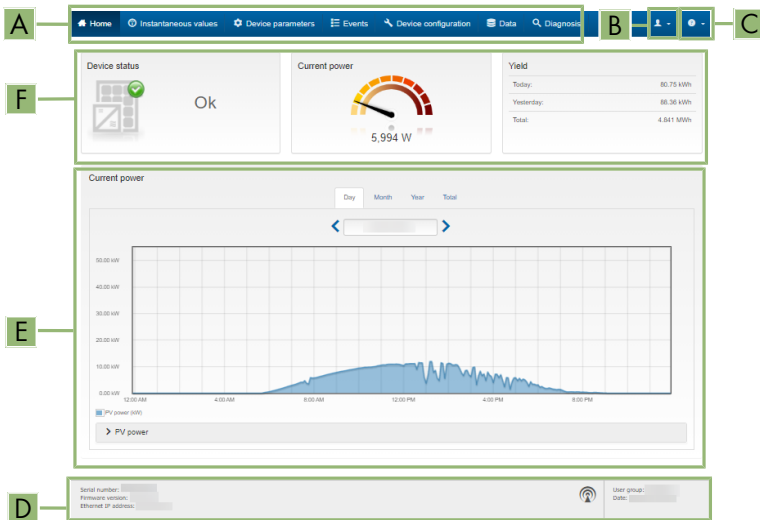

Figure 14: Design of the user interface's home page (example)

Position	Designation	Description
A	Menu	<p>Provides the following functions:</p> <ul style="list-style-type: none"> • Home Opens the user interface home page • Instantaneous values Current measured values of the inverter • Device Parameters The various operating parameters of the inverter can be viewed and configured here depending on the user group. • Events All events that have occurred in the selected time period are displayed here. The event types are Information, Warning and Error. Currently existing events of the types Error and Warning will be additionally displayed in the Device status viewlet. However, only the higher-priority event is displayed. If, for example, there is a Warning and an Error present at the same time, only the error will be displayed. • Device Configuration Various settings for the inverter can be made here. The selection available is dependent on which user group you are logged in as and the operating system of the device with which the user interface has been called up. • Data You will find all data that is saved in the internal memory of the inverter or on an external storage medium on this page. • Diagnosis Here, an I-V characteristic curve of the PV array per MPP tracker can be created and exported.
B	User settings	<p>Provides the following functions, depending on the user group logged in:</p> <ul style="list-style-type: none"> • Starting the installation assistant • Set access rights • Activating and Deactivating the Smart Inverter Screen • SMA Grid Guard login • Show eManual • Logout

Position	Designation	Description
C	Help	Provides the following functions: <ul style="list-style-type: none"> • Displaying information on Open Source licenses used • Link to the website of SMA Solar Technology AG
D	Status bar	Displays the following information: <ul style="list-style-type: none"> • Inverter serial number • Inverter firmware version • IP address of the inverter within the local network and/or IP address of the inverter during WLAN connection • With WLAN connection: Signal strength of WLAN connection • User group logged in • Date and device time of the inverter
E	Current power and current consumption	Temporal progression of the PV power and the power consumption of the household over the selected time period. Please note, the power consumption will only be displayed if an energy meter is installed in the PV system.
F	Status display	The various areas display information on the current status of the PV system. <ul style="list-style-type: none"> • Device status Displays whether the inverter is currently in a fault-free operating state or whether there is an Error or Warning present. • Current power Displays the power currently being generated by the inverter. • Modular technology status Displays how many module technology components are available and the status of each one (only present if the TS4 module technology is connected). • Yield Displays the energy yield of the inverter. • Grid supply Displays the energy supply from the utility grid. • Power at the grid connection point Indicates which power is currently fed in or obtained at the grid-connection point.

8.4 Activating the Smart Inverter Screen

With the Smart Inverter Screen, the most important inverter data is displayed directly on the user interface login page. To activate the Smart Inverter Screen, proceed as listed in the following.

Procedure:

1. Open the user interface (see Section 8.1, page 53).
 2. Log in as **Installer** or **User**.
 3. Select the menu **User Settings** (see Section 8.3, page 59) on the start page of the user interface.
 4. Select [**Smart Inverter Screen**].
- The Smart Inverter Screen has been activated.

8.5 Starting the Installation Assistant

QUALIFIED PERSON

The installation assistant leads you step-by-step through the steps necessary for the initial configuration of the inverter.

Layout of the installation assistant

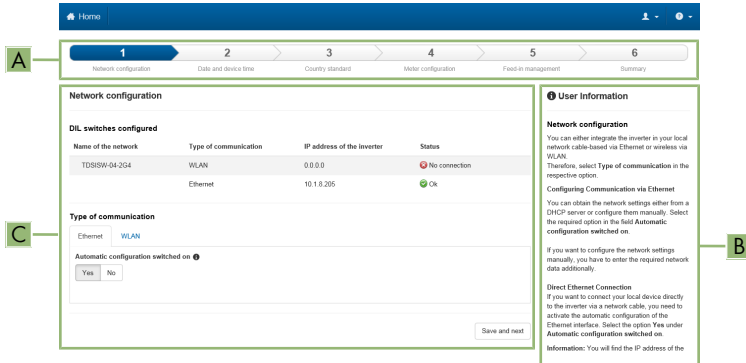

Figure 15: Layout of the installation assistant (example)

Position	Designation	Description
A	Configuration steps	Overview of the installation assistant steps. The number of steps depends on the type of device and the additionally installed modules. The current step is highlighted in blue.
B	User information	Information about the current configuration step and the setting options of the configuration step.
C	Configuration field	You can make settings in this field.

Requirement:

- The SMA Grid Guard code must be available to change network-relevant parameters after the first 10 hours of feed-in operation, or after completing the installation assistant. You can request the SMA Grid Guard code via the Online Service Center.

Procedure:

1. Open the user interface (see Section 8.1, page 53).
 2. Log in as **Installer**.
 3. Select the menu **User Settings** (see Section 8.3, page 59) on the start page of the user interface.
 4. In the context menu, select [**Starting the installation assistant**].
- The installation assistant will open.

8.6 Activate WPS Function

The WPS function can be used for different purposes:

- Automatic connection to a network (e.g. via router)
- Direct connection between the product and a smart device

Depending on the intended application of the WPS function, the procedure for activation will vary.

Activating WPS function for automatic connection to a network

Requirements:

- WLAN must be activated in the product.
- WPS must be activated on the router.

Procedure:

1. Open the user interface (see Section 8.1, page 53).
 2. Log in as **Installer**.
 3. Start the installation assistant (see Section 8.5, page 62).
 4. Select **Network configuration**.
 5. Select **WPS for WLAN network** button in the **WLAN** tab.
 6. Select **Activate WPS**.
 7. Select **Save and next** and exit the installation assistant.
- The WPS function is activated and the automatic connection to the network can be established.

Activating the WPS function for direct connection to the smart device.

- Tap on the enclosure lid of the product twice. This will activate the WPS function on the product for about 2 minutes. Activation is signaled by rapid flashing of the blue LED.

8.7 Switching WLAN On and Off

The inverter is equipped with an activated WLAN interface as standard. If you do not want to use WLAN, you can switch the WLAN function off and switch it on again whenever needed. In doing so, you can switch the WLAN direct connection and the WLAN connection in the local network on independently of each other.

Switching on the WLAN function only possible via Ethernet connection

If you switch off both the WLAN function for the direct connection and for the connection in the local network, access to the inverter user interface and therefore reactivation of the WLAN interface is only possible via an Ethernet connection.

The basic procedure for changing operating parameters is explained in another section (see Section 8.12, page 67).

Switching WLAN Off

If you would like to switch the WLAN function off completely, you must switch off both the direct connection and the connection in the local network.

Procedure:

- To switch off the direct connection in the parameter group **System communication > WiFi**, select the parameter **Soft-access-point is turned on** and set it to **No**.
- To switch off the connection in the local network in the parameter group **System communication > WiFi**, select the parameter **WiFi is turned on** and set it to **No**.

Switching WLAN On

If you have switched the WLAN function for direct connection or for connection in the local network off, you can switch the WLAN function back on in accordance with the following procedure.

Requirement:

- If the WLAN function was previously switched off completely, the inverter must be connected to a computer or router via Ethernet.

Procedure:

- To switch on the Wi-Fi direct connection in the parameter group **System communication > WiFi**, select the parameter **Soft-access-point is turned on** and set it to **Yes**.
- To switch on the Wi-Fi connection in the local network in the parameter group **System communication > WiFi**, select the parameter **WiFi is turned on** and set it to **Yes**.

8.8 Switching the Dynamic Power Display Off

As standard, the product signals its power dynamically via the pulsing of the green LED. When doing so, the LED flashes on and off uniformly or is permanently lit at full power. The various gradations are related here to the set active power limit of the product. If this display is not desired, switch this function off in accordance with the following procedure. Once this has been done, the green LED is lit permanently to signalize feed-in operation.

The basic procedure for changing operating parameters is explained in another section (see Section 8.12, page 67).

Procedure:

- In the parameter group **Device > Operation**, select the parameter **Dynamic power display via green LED** and set it to **Off**.

8.9 Changing the Password

The password for the product can be changed for both user groups. Furthermore, the user group **Installer** can change the password for the user group **User** as well as their own password.

i PV systems registered in a communication product

With PV systems that are registered in a communication product (e.g. Sunny Portal, Sunny Home Manager), you can also assign a new password for the user group **Installer** via the communication product. The password for the user group **Installer** is also the system password. If you assign a password for the user group **Installer** via the user interface of the inverter that does not correspond to the system password in the communication product, the inverter can no longer be reached by the communication product.

- Ensure that the password of the **Installer** user group corresponds to the system password in the communication product.

Procedure:

1. Open the user interface (see Section 8.1, page 53).
2. Log into the user interface (see Section 8.2, page 57).
3. Call up the menu **Device parameters**.
4. Click on **[Edit parameters]**.
5. In the parameter group **User Rights > Access Control** change the password of the desired user group.
6. Select **[Save all]** to save the changes.

8.10 Generating or Changing a Product Key

If you have forgotten the product's password, you can use the product key to create a new one. The product key is stored only on the device. A lost product key cannot be recovered, it can only be recreated. Creating a product key is not mandatory, but is recommended by SMA Solar Technology AG because the product key significantly increases the security of the system.

Generating a product key for the first time

A product key must be generated for each of the groups **User** and **Installer**.

Procedure:

1. Open the user interface (see Section 8.1, page 53).
2. Log into (see Section 8.2, page 57) the user interface as **User** or as **Installer**.
3. Select the menu **User settings**.
4. Select **[Access rights]**.
5. Select **[Product key]**.

6. Enter the specific device secret of the product. Which specific device secret is used and where you can find the specific device secret is indicated on the user interface.
7. Click on **[Generate]**.
 - A string representing the product key is generated.
8. Write down the product key immediately and keep it safe. After leaving this page, the newly generated product key can no longer be displayed. The copy of the product key must be accessible only to you.

Generate new product key

If the product key has become accessible to unauthorized persons, you can generate a new product key at any time. To generate a new product key, the currently valid product key must be available.

Procedure:

1. Open the user interface (see Section 8.1, page 53).
2. Log into (see Section 8.2, page 57) the user interface as **User** or as **Installer**.
3. Select the menu **User settings**.
4. Select **[Access rights]**.
5. Select **[Product key]**.
6. Enter the currently valid product key.
7. Click on **[Generate]**.
 - A string representing the new product key is generated.
8. Write down the new product key immediately and keep it safe. After leaving this page, the newly generated product key can no longer be displayed. The previously valid product key is invalid after a new product key is generated. The copy of the product key must be accessible only to you.

8.11 Configuring the Service Access

In the event of a malfunction of the product, it may be necessary for a service user authorized by SMA Solar Technology AG to access the user interface of the product.

Service access must be activated to execute warranty services. If a quick and uncomplicated service intervention is to be enabled in an emergency, the service access must be permanently activated.

Service access can be activated or deactivated at any time.

Procedure:

1. Open the user interface (see Section 8.1, page 53).
2. Log into (see Section 8.2, page 57) the user interface as **User** or as **Installer**.
3. Select the menu **User settings**.
4. Select **[Access rights]**.
5. Select **[Service]**.
6. Enable or disable service access using the drop-down list:

7. To activate service access permanently, click **Yes, permanently** in the drop-down list.
8. To enable service access for a specific time, click **Yes, temporary** in the drop-down list and adjust the expiration date if necessary.
9. To deactivate service access, click **No** in the drop-down list.
10. Click on [**Save**] to save the changes.

8.12 Changing Operating Parameters

The parameters of the inverter are set to certain values by default. You can change the parameters to optimize the performance of the inverter.

This section describes the basic procedure for changing operating parameters. Always change operating parameters as described in this section.

Some function-sensitive parameters can only be viewed by qualified persons and can only be changed by qualified persons by entering the personal SMA Grid Guard code. You can request the SMA Grid Guard code via the Online Service Center.

No configuration via Sunny Explorer

Sunny Explorer does not support the configuration of inverters with their own user interface. The inverter can be detected via Sunny Explorer, however it is expressly not recommended to use Sunny Explorer to configure this inverter. SMA Solar Technology AG does not accept liability for missing or incorrect data and possibly resulting yield losses.

- Use the inverter's user interface for configuration.

Requirements:

- Changes to grid-relevant parameters must be approved by the responsible grid operator.

Procedure:

1. Open the user interface (see Section 8.1, page 53).
 2. Log into the user interface (see Section 8.2, page 57).
 3. Call up the menu **Device parameters**.
 4. Click on [**Edit parameters**].
 5. Navigate to the parameter or use the search function. In the view and search, it is possible to switch between channel and name.
 6. Log in using the SMA Grid Guard code to change those parameters designated by a lock (only for installers). In the menu, select **User Settings > SMA Grid Guard Login**, enter the SMA Grid Guard code and select [**Login**].
 7. Change the required parameters.
 8. Select [**Save all**] to save the changes.
- The parameters are set.

i Accepting the settings

Saving the made settings is indicated by an hourglass symbol on the user interface. If the DC voltage is sufficient, the data is transferred directly to the inverter and accepted. If the DC voltage is too low (e. g. in the evening), the settings are saved, but they cannot be directly transferred to or accepted by the inverter. As long as the inverter has not yet received and accepted the settings, the hourglass symbol will continue to be displayed on the user interface. The settings will be accepted when there is sufficient DC voltage applied and the inverter restarts. As soon as the hourglass symbol appears on the user interface, the settings have been saved. The settings will not be lost. You can log off of the user interface and leave the system.

8.13 Configuring the Country Data Set

⚠ QUALIFIED PERSON

For the product to begin operation, a country data set must be set (for instance via the installation assistant on the user interface of the product, or via a communication product). As long as no country data set is set, operation of the product will remain stopped. This state is signaled by the green and red LEDs flashing simultaneously. Once configuration of the product is completed, the product will start operating automatically.

By default, the inverter is set to a universally valid country data set. You must adjust the country data set for the installation site.

i The country data set must be set correctly.

If you select a country data set which is not valid for your country and purpose, it can cause a disturbance in the PV system and lead to problems with the grid operator. When selecting the country data set, you must always observe the locally applicable standards and directives as well as the properties of the PV system (e.g. PV system size, grid-connection point).

- If you are not sure which standards and directives are valid for your country or purpose, contact the grid operator.

i Change to the names and units of grid parameters to comply with the grid-connection requirements in accordance with Regulation (EU) 2016/631 (valid from April 27, 2019)

To comply with the EU grid-connection requirements (valid from April 27, 2019) the names and units of grid parameters were changed. This change is valid from firmware version $\geq 3.00.00.R$ if a country data set for fulfilling the EU grid-connection requirements (valid from 2019-04-27) is set. Names and units of grid parameters for inverters with firmware version $\leq 2.99.99.R$ are not affected by this change and remain valid. This also applies from firmware version $\geq 3.00.00.R$ if a country data set that is valid for countries outside the EU is set.

The basic procedure for changing operating parameters is explained in another section (see Section 8.12, page 67).

Procedure:

- In the parameter group **Grid Monitoring > Grid Monitoring** select the parameter **Set country standard** and set the required country data set.

8.14 Configuring the Active Power Mode

⚠ QUALIFIED PERSON

Starting the Installation Assistant

1. Open the user interface (see Section 8.1, page 53).
2. Log in as **Installer**.
3. Start the installation assistant (see Section 8.5, page 62).
4. Select [**Save and continue**] after each step up until the step **Grid management service**.
5. Make the settings as described in the following.

Setting the connected line conductors

- In the tab **Active power mode** from the drop-down list **Connected line conductors**, select the line conductor to which the inverter is connected.

Make the settings for systems with external setpoint

1. Set the **Grid connection point regulation** to [**Off**].
2. In the tab **Active power mode** set the switch **Active power setpoint** to [**On**].
3. In the drop-down list **Operating mode active power setpoint**, select the entry **External setpoint**.
4. In the drop-down list **Fallback behavior**, select the entry **Apply fallback values**.
5. In the field **Fallback value of maximum active power** enter the value to which the inverter is to limit its rated power in case of a communication failure to the higher control unit at the end of the timeout time.
6. In the field **Timeout**, enter the time that the inverter is to wait before it limits its rated power to the set fallback value.
7. If, in the event of a 0% or 0 W specification, the inverter is not permitted to feed small amounts of active power into the utility grid, select the entry **Yes** in the drop-down list **Grid disconnection for 0% active power setting**. This ensures that in the event of a 0% or 0 W specification, the inverter disconnects from the utility grid and does not feed in active power.

Make the settings for systems with manual setpoint

1. In the tab **Active power mode** set the switch **Grid connection point regulation** to [**On**].
2. Enter the total power of the PV modules in the field **Nominal PV system power**.
3. In the drop-down list **Operating mode of act. power limit. at grid connection pt**, select whether active power limitation is to be performed via a fixed specification in percent or in watts.
4. In the field **Set active power limit at grid connection point**, enter the value to which the active power at the point of interconnection is to be limited. The value must be set to **0** for zero power output.
5. Set **Active power setpoint** to [**On**].

6. For the manual preset, in the drop-down list **Operating mode active power setting**, select **Manual setting in %** or **Manual setting in W** and enter the respective default value in the field **Active power**.
7. If the inverter itself is to control the active power at the point of interconnection, select **External setting** in the **Operating mode active power setting** drop-down list, select **Apply fallback values** in the **Fallback behavior** drop-down list, and select **No** in the **Grid disconnection for 0% active power setting** drop-down list.

8.15 Configuring the Modbus Function

QUALIFIED PERSON

The Modbus interface is deactivated by default and the communication ports 502 set.

In order to access SMA inverters with SMA Modbus[®] or SunSpec[®] Modbus[®], the Modbus interface must be enabled. After enabling the interface, the communication ports of both IP protocols can be changed. For information on commissioning and configuration of the Modbus interface, see the technical information "SMA and SunSpec Modbus[®] Interface" at www.SMA-Solar.com.

For information on which Modbus registers are supported, see the technical information "Modbus[®] parameters and measured values" at www.SMA-Solar.com.

Measures for data security during activated Modbus interface

If you activate the Modbus interface, there is a risk that unauthorized users may access and manipulate the data or devices in your PV system.

To ensure data security, take appropriate protective measures such as:

- Set up a firewall.
- Close unnecessary network ports.
- Only enable remote access via VPN tunnel.
- Do not set up port forwarding at the communication port in use.
- In order to deactivate the Modbus interface, reset the inverter to the default settings or deactivate the activated parameter again.

Procedure:

- Activate the Modbus interface and adjust the communication ports if necessary (see the technical information "SMA MODBUS" or "SUNSPEC MODBUS" at www.SMA-Solar.com).

8.16 Activating the Receipt of Control Signals (Only for Italy)

QUALIFIED PERSON

In order for PV systems in Italy to receive control commands from the grid operator, set the following parameters.

The basic procedure for changing operating parameters is explained in another section (see Section 8.12, page 67).

Parameter	Value/range	Resolution	Default
Application-ID	0 to 16384	1	16384
Goose-Mac address	01:0C:CD:01:00:00 to 01:0C:CD:01:02:00	1	01:0C:CD:01:00:00

Procedure:

1. Select the parameter group **External Communication > IEC 61850 configuration**.
 2. Set the parameter **IEC server switched on** to **Yes**.
 3. Select the parameter group **GOOSE configuration**.
 4. Select the parameter **Application-ID** and enter the GOOSE application ID determined by the grid operator. 16384 is set by default. With the default value the processing of GOOSE messages is disabled. Only with a valid Application-ID the processing of GOOSE messages can be activated.
 5. Select the parameter **Goose-Mac address** and enter the MAC address of the grid operator gateway from which the inverter is to receive the control commands. You will receive this value from your grid operator.
 6. Select [**Save all**].
 7. Restart the inverter. For this: Switch off the DC load-break switch. Wait 5 minutes. Switch on the DC load-break switch again.
- The receipt of control signals from the grid operator is activated.

8.17 Deactivating Grounding Conductor Monitoring

QUALIFIED PERSON

If the inverter is to be installed in an IT network or another grid configuration in which deactivation of the grounding conductor monitoring is required, deactivate the grounding conductor monitoring as follows.

The basic procedure for changing operating parameters is explained in another section (see Section 8.12, page 67).

Procedure:

- In the parameter group **Grid Monitoring > Grid Monitoring > Country standard**, select the parameter **PE connection monitoring** and set it to **Off**.

8.18 Setting SMA ShadeFix

QUALIFIED PERSON

You can set the time interval in which the inverter has to determine the optimum operating point and to optimize the MPP of the PV system. If you do not want to use SMA ShadeFix, you can disable the feature.

The basic procedure for changing operating parameters is explained in another section (see Section 8.12, page 67).

Procedure:

- In the parameter group **DC Side > DC settings > SMA ShadeFix**, select the parameter **Cycle time of SMA ShadeFix** and set the required time interval. The ideal time interval is usually 6 minutes. This value should only be increased if the shading situation changes extremely slowly.
- In order to disable the SMA ShadeFix feature, in the parameter group **DC Side > DC settings > SMA ShadeFix**, set the parameter **SMA ShadeFix** to **Off**.

8.19 Generating characteristic curves

During the measurement, the inverter can briefly interrupt the feed-in or feed in with reduced power. The duration of a measurement is approx. 20 seconds per DC inputs. To avoid misuse of the function and thus yield loss, the measurement can be carried out a maximum of 10 times per day. If more than 10 measurements per day are to be carried out, the inverter must be restarted.

The measuring curve has over 200 measuring points. The display is from 0 V up to the maximum MPP voltage of the inverter. The current is limited by the maximum possible input current of the inverter.

The measurement curve can be visualized as an I-V characteristic curve or as a power/voltage characteristic curve (P-V characteristic curve).

The data is stored on the user interface until the next measurement.

Further information as well as help for the interpretation of the I-V-characteristic curve can be found in the technical information "I-V and P-V diagnostics function: Using the inverter to determine the generator's characteristic curve to detect faults in PV modules".

i Using the function when using external module optimizers is not recommended.

Using the function when using external module optimizers does not produce interpretable results and is therefore not recommended.

Requirements:

- In order to avoid misinterpretation of the determined characteristic curve at low powers, a measurement should be carried out at at least 50% of the inverter's nominal power.
- In the case of comparative measurements (e.g. at annual intervals), similar ambient conditions (solar irradiation, shading, temperature) should prevail.

Procedure:

1. Log on to the user interface of the inverter.
2. Click on **Diagnosis** in the menu.
3. Click on [**Start new measurement**].
4. Go to [**PDF export**] or [**CSV export**] to export the data shown.

8.20 Setting the Rated Residual Current of the Residual-Current Device

QUALIFIED PERSON

When using residual-current devices with a rated residual current of 30 mA, set the rated residual current to 30 mA. In this way the inverter reduces the operational leakage currents and prevents a false triggering of the residual-current device (further information see technical information "Leading Leakage Currents" at www.SMA-Solar.com).

The basic procedure for changing operating parameters is explained in another section (see Section 8.12, page 67).

Procedure:

- Select the **RCD adjustment** parameter and set it to **30 mA**.

8.21 Activating or Deactivating SMA ArcFix

QUALIFIED PERSON

The basic procedure for changing operating parameters is explained in another section (see Section 8.12, page 67).

Activate arc-fault circuit interrupter (AFCI)

Procedure:

- In the parameter group **Device > Inverter**, select the parameter **AFCI switched on** and set it to **Yes**.

Deactivating the Arc-Fault Circuit Interrupter (AFCI)

Procedure:

- In the parameter group **Device > Inverter**, select the parameter **AFCI switched on** and set it to **No**.

8.22 Saving the Configuration in a File

You can save the current configuration of the inverter in a file. You can use this file as a data backup for this inverter and then import this file into this inverter again or another inverter from the same type or device family to configure the inverter. When saving, only the device parameters will be saved, not any passwords.

Procedure:

1. Open the user interface (see Section 8.1, page 53).
2. Log into the user interface (see Section 8.2, page 57).
3. Select the menu **Device Configuration**.
4. Select [**Settings**].
5. In the context menu, select [**Saving the configuration in a file**].
6. Follow the instructions in the dialog.

8.23 Adopting a Configuration from a File

QUALIFIED PERSON

To configure the inverter, you can adopt the configuration from a file. To be able to do this, you must first save the configuration of another inverter from the same type or device family in a file (see Section 8.22, page 73). When saving, only the device parameters will be adopted, not any passwords.

Requirements:

- Changes to grid-relevant parameters must be approved by the responsible grid operator.
- The SMA Grid Guard code must be available. You can request the SMA Grid Guard code via the Online Service Center.

Procedure:

1. Open the user interface (see Section 8.1, page 53).
2. Log into (see Section 8.2, page 57) the user interface as **Installer**.
3. Select the menu **Device Configuration**.
4. Select [**Settings**].
5. In the context menu, select [**Adopting the configuration from a file**].
6. Follow the instructions in the dialog.

8.24 Firmware Update

You can activate an automatic firmware update in the inverter or in the communication product.

If no automatic update is set in the communication product (e.g. SMA Data Manager or Sunny Home Manager) or in Sunny Portal, you have the option of carrying out a manual firmware update.

You have the following options to update the firmware:

- Automatic Firmware Update (Recommended)
- Update the firmware with the existing update file via the user interface of the inverter.
- Search and install the firmware via the user interface of the inverter.

8.24.1 Activating Automatic Firmware Update

QUALIFIED PERSON

You can activate the automatic firmware update in the inverter or in the communication product.

If the automatic firmware update is activated in the inverter, the inverter searches for updates and carries out the update.

If the automatic firmware update is activated in the communication product, the communication product searches for updates for the inverter and carries out the update of the inverter. In this case, the automatic firmware update is deactivated by default in the inverter. This prevents multiple downloads of updates.

In this section we describe how to activate the automatic firmware update in the inverter. The procedure for activating the automatic firmware update for detected devices in the communication product can be found in the manual for the communication product.

The basic procedure for changing operating parameters is explained in another section (see Section 8.12, page 67).

Procedure:

- In the parameter group **Device > Update**, select the parameter **Automatic update** and set it to **Yes**.

8.24.2 Updating Firmware with Update File via the User Interface

QUALIFIED PERSON

Requirements:

- An update file with the desired inverter firmware must be available. The update file is, for example, available for download on the product page of the inverter at www.SMA-Solar.com. To download the update file, it is necessary to enter the serial number of the inverter.

Procedure:

1. Open the user interface (see Section 8.1, page 53).
2. Log into (see Section 8.2, page 57) the user interface as **Installer**.
3. Click on **[Edit parameters]**.
4. Select the menu **Device Configuration**.
5. In the product row, click on the gear icon and select **Update firmware**.
6. Select **[Browse]** and select the update file for the product.
7. Select **Update firmware**.
8. Follow the instructions in the dialog.

8.24.3 Searching for and Installing New Firmware via the User Interface

QUALIFIED PERSON

Requirement:

- The inverter must be connected to the Internet.

Procedure:

1. Open the user interface (see Section 8.1, page 53).
2. Log into (see Section 8.2, page 57) the user interface as **Installer**.
3. Select the menu **Device Parameters**.
4. Click on **[Edit parameters]**.
5. Select **Device > Update**.

6. Select the **Check for update and install it** parameter and set it to **Execute**.
 7. Click on [**Save all**].
- The firmware is updated in the background.

9 Disconnecting the Inverter from Voltage Sources

⚠ QUALIFIED PERSON

Prior to performing any work on the product, always disconnect it from all voltage sources as described in this section. Always adhere to the prescribed sequence.

⚠ WARNING

Danger to life due to electric shock from destruction of the measuring device due to overvoltage

Overvoltage can damage a measuring device and result in voltage being present in the enclosure of the measuring device. Touching the live enclosure of the measuring device results in death or lethal injuries due to electric shock.

- Only use measuring devices with a DC input voltage range of 600 V or higher.

Procedure:

1. Disconnect the AC miniature circuit breaker and secure against reconnection.
2. Turn the DC load-break switch to the position **O**.

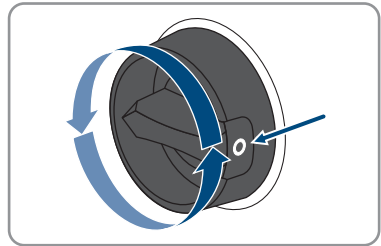

3. If your country requires the DC load-break switch to be protected against reconnection, secure the DC load-break switch against reconnection with a padlock.

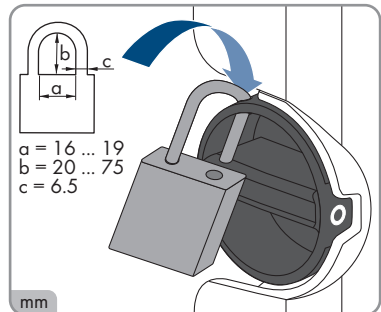

4. Wait until the LEDs have gone out.

5. Use a current clamp to ensure that no current is present in the DC cables.

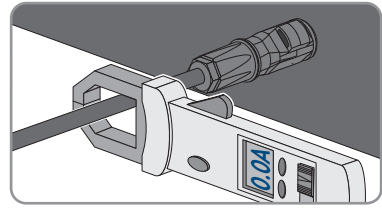

6. **⚠ DANGER**

Danger to life due to electric shock when touching exposed DC conductors or DC plug contacts if the DC connectors are damaged or loose

The DC connectors can break or become damaged, become free of the DC cables, or no longer be connected correctly if the DC connectors are released and disconnected incorrectly. This can result in the DC conductors or DC plug contacts being exposed. Touching live DC conductors or DC plug connectors will result in death or serious injury due to electric shock.

- Wear insulated gloves and use insulated tools when working on the DC connectors.
- Ensure that the DC connectors are in perfect condition and that none of the DC conductors or DC plug contacts are exposed.
- Carefully release and remove the DC connectors as described in the following.

7. Release and remove the DC connectors. To do so, insert a flat-blade screwdriver or an angled screwdriver (blade width: 3.5 mm) into one of the side slots and pull the DC connectors out. When doing so, do not lever the DC connectors out, but insert the tool into one of the side slots only to release the locking mechanism, and do not pull on the cable.

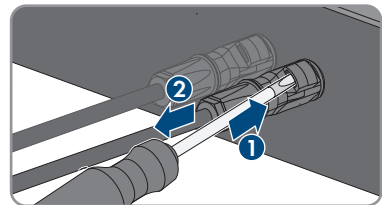

8. Ensure that no voltage is present between the positive terminal and negative terminal at the DC inputs using a suitable measuring device.

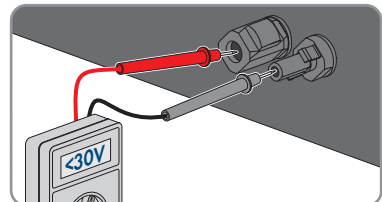

9. Ensure that no voltage is present between the positive terminal and ground as well as between the negative terminal and ground on the DC inputs using a suitable measuring device.

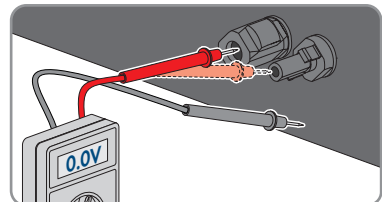

10. Unlock the AC connector and pull it out of the socket for the AC connection.

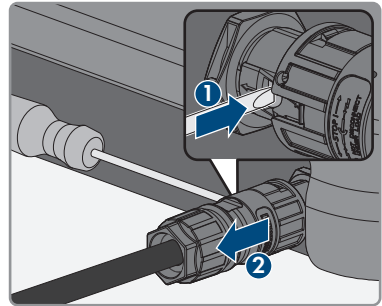

10 Cleaning the Product

NOTICE

Damage to the product due to cleaning agents

The use of cleaning agents may cause damage to the product and its components.

- Clean the product and all its components only with a cloth moistened with clear water.

Procedure:

- Ensure that the product is free of dust, leaves and other dirt.

11 Troubleshooting

11.1 Product Key Lost

If you have forgotten the password for the product and additionally lost the product key, use the procedure described below to generate a new password. The procedure requires physical access to the product.

Password assignment for inverters that are registered in a communication product

The password for the user group **Installer** is also the system password for the PV system in the communication product. Changing the password of the user group **Installer** can lead to the inverter no longer being able to be reached by the communication product.

- In the communication product, assign the changed password of the user group **Installer** as the new system password (see the manual of the communication product).

Procedure:

1. Open the user interface (see Section 8.1, page 53).
2. Select user group **User** or **Installer**.
3. Click on **[Forgot your password?]**.
4. Click on **[Product key lost?]** wählen. If you have not yet generated a product key, the name of the specific device secret is displayed instead of **Product key**. In this case, click on **[### lost?]**.
5. Read the help text and enter a new password.
6. Click on **[Next]**.
7. Perform one of the displayed actions within the specified time period.
 - A newly generated product key is displayed.
 - If the action performed was tapping the enclosure lid 2 times, the blue LED will flash rapidly.
8. Write down the new product key immediately and keep it safe. After leaving this page, the newly generated product key can no longer be displayed. The previously valid product key is invalid after a new product key is generated. The copy of the product key must be accessible only to you.
9. Select **[Login]**.
 - You are logged in on the user interface of the product.

11.2 Event messages

11.2.1 Event 101

QUALIFIED PERSON

Event message:

- **Grid incident**

Explanation:

The grid voltage or grid impedance at the connection point of the inverter is too high. The inverter has disconnected from the utility grid.

Corrective measures:

- Check whether the grid voltage at the connection point of the inverter is permanently in the permissible range.

If the grid voltage is outside the permissible range due to local grid conditions, contact the grid operator. The grid operator must agree with an adjustment of the voltage at the feed-in point or with a change of the monitored operating limits.

If the grid voltage is permanently within the permissible range and this message is still displayed, contact the Service.

11.2.2 Event 102

QUALIFIED PERSON

Event message:

- **Grid incident**

Explanation:

The grid voltage or grid impedance at the connection point of the inverter is too high. The inverter has disconnected from the utility grid.

Corrective measures:

- Check whether the grid voltage at the connection point of the inverter is permanently in the permissible range.

If the grid voltage is outside the permissible range due to local grid conditions, contact the grid operator. The grid operator must agree with an adjustment of the voltage at the feed-in point or with a change of the monitored operating limits.

If the grid voltage is permanently within the permissible range and this message is still displayed, contact the Service.

11.2.3 Event 103

QUALIFIED PERSON

Event message:

- **Grid incident**

Explanation:

The grid voltage or grid impedance at the connection point of the inverter is too high. The inverter has disconnected from the utility grid.

Corrective measures:

- Check whether the grid voltage at the connection point of the inverter is permanently in the permissible range.

If the grid voltage is outside the permissible range due to local grid conditions, contact the grid operator. The grid operator must agree with an adjustment of the voltage at the feed-in point or with a change of the monitored operating limits.

If the grid voltage is permanently within the permissible range and this message is still displayed, contact the Service.

11.2.4 Event 104

QUALIFIED PERSON

Event message:

- **Grid incident**

Explanation:

The grid voltage or grid impedance at the connection point of the inverter is too high. The inverter has disconnected from the utility grid.

Corrective measures:

- Check whether the grid voltage at the connection point of the inverter is permanently in the permissible range.

If the grid voltage is outside the permissible range due to local grid conditions, contact the grid operator. The grid operator must agree with an adjustment of the voltage at the feed-in point or with a change of the monitored operating limits.

If the grid voltage is permanently within the permissible range and this message is still displayed, contact the Service.

11.2.5 Event 105

QUALIFIED PERSON

Event message:

- **Grid incident**

Explanation:

The grid voltage or grid impedance at the connection point of the inverter is too high. The inverter has disconnected from the utility grid.

Corrective measures:

- Check whether the grid voltage at the connection point of the inverter is permanently in the permissible range.

If the grid voltage is outside the permissible range due to local grid conditions, contact the grid operator. The grid operator must agree with an adjustment of the voltage at the feed-in point or with a change of the monitored operating limits.

If the grid voltage is permanently within the permissible range and this message is still displayed, contact the Service.

11.2.6 Event 202**⚠ QUALIFIED PERSON****Event message:**

- **Grid incident**

Explanation:

The utility grid has been disconnected, the AC cable is damaged or the grid voltage at the connection point of the inverter is too low. The inverter has disconnected from the utility grid.

Corrective measures:

- Ensure that the miniature circuit breaker is switched on.
- Ensure that the AC cable is not damaged and that it is connected correctly.
- Ensure that the country data set has been configured correctly.
- Check whether the grid voltage at the connection point of the inverter is permanently in the permissible range.

If the grid voltage is outside the permissible range due to local grid conditions, contact the grid operator. The grid operator must agree with an adjustment of the voltage at the feed-in point or with a change of the monitored operating limits.

If the grid voltage is permanently within the permissible range and this message is still displayed, contact the Service.

11.2.7 Event 203**⚠ QUALIFIED PERSON****Event message:**

- **Grid incident**

Explanation:

The utility grid has been disconnected, the AC cable is damaged or the grid voltage at the connection point of the inverter is too low. The inverter has disconnected from the utility grid.

Corrective measures:

- Ensure that the miniature circuit breaker is switched on.

- Ensure that the AC cable is not damaged and that it is connected correctly.
- Ensure that the country data set has been configured correctly.
- Check whether the grid voltage at the connection point of the inverter is permanently in the permissible range.

If the grid voltage is outside the permissible range due to local grid conditions, contact the grid operator. The grid operator must agree with an adjustment of the voltage at the feed-in point or with a change of the monitored operating limits.

If the grid voltage is permanently within the permissible range and this message is still displayed, contact the Service.

11.2.8 Event 205

QUALIFIED PERSON

Event message:

- **Grid incident**

Explanation:

The utility grid has been disconnected, the AC cable is damaged or the grid voltage at the connection point of the inverter is too low. The inverter has disconnected from the utility grid.

Corrective measures:

- Ensure that the miniature circuit breaker is switched on.
- Ensure that the AC cable is not damaged and that it is connected correctly.
- Ensure that the country data set has been configured correctly.
- Check whether the grid voltage at the connection point of the inverter is permanently in the permissible range.

If the grid voltage is outside the permissible range due to local grid conditions, contact the grid operator. The grid operator must agree with an adjustment of the voltage at the feed-in point or with a change of the monitored operating limits.

If the grid voltage is permanently within the permissible range and this message is still displayed, contact the Service.

11.2.9 Event 206

QUALIFIED PERSON

Event message:

- **Grid incident**

Explanation:

The utility grid has been disconnected, the AC cable is damaged or the grid voltage at the connection point of the inverter is too low. The inverter has disconnected from the utility grid.

Corrective measures:

- Ensure that the miniature circuit breaker is switched on.
- Ensure that the AC cable is not damaged and that it is connected correctly.
- Ensure that the country data set has been configured correctly.
- Check whether the grid voltage at the connection point of the inverter is permanently in the permissible range.

If the grid voltage is outside the permissible range due to local grid conditions, contact the grid operator. The grid operator must agree with an adjustment of the voltage at the feed-in point or with a change of the monitored operating limits.

If the grid voltage is permanently within the permissible range and this message is still displayed, contact the Service.

11.2.10 Event 301**⚠ QUALIFIED PERSON****Event message:**

- **Grid incident**

Explanation:

The ten-minute average value of the grid voltage is no longer within the permissible range. The grid voltage or grid impedance at the connection point is too high. The inverter disconnects from the utility grid to maintain power quality.

Corrective measures:

- During the feed-in operation, check whether the grid voltage at the connection point of the inverter is permanently in the permissible range.

If the grid voltage is outside the permissible range due to local grid conditions, contact the grid operator. The grid operator must agree with an adjustment of the voltage at the feed-in point or with a change of the monitored operating limits.

If the grid voltage is permanently within the permissible range and this message is still displayed, contact the Service.

11.2.11 Event 302**⚠ QUALIFIED PERSON****Event message:**

- **Active power limited AC voltage**

Explanation:

The inverter has reduced its power due to a too-high grid voltage to ensure grid stability.

Corrective measures:

- If possible, check the grid voltage and observe how often fluctuations occur. If fluctuations occur frequently and this message is displayed often, contact the grid operator and request approval to change the operating parameters of the inverter. If the grid operator gives approval, discuss any changes to the operating parameters with the Service.

11.2.12 Event 401

⚠ QUALIFIED PERSON**Event message:**

- **Grid incident**

Explanation:

The inverter has disconnected from the utility grid. A stand-alone grid or a very large change in the grid frequency was detected.

Corrective measures:

- Make sure there is no power outage or work being done on the utility grid and contact a grid operator if necessary.
- Check the grid connection for significant short-term frequency fluctuations.

11.2.13 Event 404

⚠ QUALIFIED PERSON**Event message:**

- **Grid incident**

Explanation:

The inverter has disconnected from the utility grid. A stand-alone grid or a very large change in the grid frequency was detected.

Corrective measures:

- Make sure there is no power outage or work being done on the utility grid and contact a grid operator if necessary.
- Check the grid connection for significant short-term frequency fluctuations.

11.2.14 Event 501

⚠ QUALIFIED PERSON**Event message:**

- **Grid incident**

Explanation:

The grid frequency is not within the permissible range. The inverter has disconnected from the utility grid.

Corrective measures:

- If possible, check the grid frequency and observe how often fluctuations occur.
If fluctuations occur frequently and this message is displayed often, contact the grid operator and request approval to change the operating parameters of the inverter.
If the grid operator gives approval, discuss any changes to the operating parameters with the Service.

11.2.15 Event 502

⚠ QUALIFIED PERSON**Event message:**

- **Grid incident**

Explanation:

The grid frequency is not within the permissible range. The inverter has disconnected from the utility grid.

Corrective measures:

- If possible, check the grid frequency and observe how often fluctuations occur.
If fluctuations occur frequently and this message is displayed often, contact the grid operator and request approval to change the operating parameters of the inverter.
If the grid operator gives approval, discuss any changes to the operating parameters with the Service.

11.2.16 Event 503

⚠ QUALIFIED PERSON**Event message:**

- **Grid incident**

Explanation:

The grid frequency is not within the permissible range. The inverter has disconnected from the utility grid.

Corrective measures:

- If possible, check the grid frequency and observe how often fluctuations occur.
If fluctuations occur frequently and this message is displayed often, contact the grid operator and request approval to change the operating parameters of the inverter.
If the grid operator gives approval, discuss any changes to the operating parameters with the Service.

11.2.17 Event 507

QUALIFIED PERSON

Event message:

- **Active power limit AC frequency**

Explanation:

The inverter has reduced its power due to a too-high grid frequency to ensure grid stability.

Corrective measures:

- If possible, check the grid frequency and observe how often fluctuations occur. If fluctuations occur frequently and this message is displayed often, contact the grid operator and request approval to change the operating parameters of the inverter. If the grid operator gives approval, discuss any changes to the operating parameters with the Service.

11.2.18 Event 601

QUALIFIED PERSON

Event message:

- **Grid incident**

Explanation:

The inverter has detected an excessively high proportion of direct current in the grid current.

Corrective measures:

- Check the grid connection for direct current.
- If this message is displayed frequently, contact the grid operator and check whether the monitoring threshold on the inverter can be raised.

11.2.19 Event 701

QUALIFIED PERSON

Event message:

- **Frequency not permitted**
- **Check parameter**

Explanation:

The grid frequency is not within the permissible range. The inverter has disconnected from the utility grid.

Corrective measures:

- Check the AC wiring from the inverter to the feed-in meter.

- If possible, check the grid frequency and observe how often fluctuations occur.
If fluctuations occur frequently and this message is displayed often, contact the grid operator and request approval to change the operating parameters of the inverter.
If the grid operator gives approval, discuss any changes to the operating parameters with the Service.

11.2.20 Event 901

QUALIFIED PERSON

Event message:

- PE connection missing
- Check connection

Explanation:

The grounding conductor is not correctly connected.

Corrective measures:

- Ensure that the grounding conductor is correctly connected.

11.2.21 Event 1001

QUALIFIED PERSON

Event message:

- L / N swapped

Explanation:

Incorrect installation of the L / N connection.

Corrective measures:

- Check the AC wiring from the inverter to the feed-in meter.
- Check the AC voltages on the inverter connection.
- If this message is still displayed, contact the Service.

11.2.22 Event 1101

QUALIFIED PERSON

Event message:

- Installation error
- Check connection

Explanation:

A second line conductor is connected to N.

Corrective measures:

- Connect the neutral conductor to N.

11.2.23 Event 1302

⚠ QUALIFIED PERSON**Event message:**

- **Waiting for grid voltage**
- **Grid connection installation failure**
- **Check grid and fuses**

Explanation:

L or N not connected.

Corrective measures:

- Ensure that the line conductors are connected.
- Ensure that the miniature circuit breaker is switched on.
- Ensure that the AC cable is not damaged and that it is connected correctly.

11.2.24 Event 1501

⚠ QUALIFIED PERSON**Event message:**

- **Reconnection fault grid**

Explanation:

The changed country standard or the value of a parameter you have set does not correspond to the local requirements. The inverter cannot connect to the utility grid.

Corrective measures:

- Ensure that the country data set has been configured correctly. To do this, select the parameter **Set country standard** and check the value.

11.2.25 Event 3302

⚠ QUALIFIED PERSON**Event message:**

- **Unstable operation**

Explanation:

There is not enough power at the DC input of the inverter for stable operation. The inverter cannot connect to the utility grid.

Corrective measures:

- Ensure that the PV module is dimensioned correctly.
- Ensure that the PV module is not covered by snow or otherwise shaded.
- Ensure that the PV module is free of defects.

11.2.26 Event 3303**⚠ QUALIFIED PERSON****Event message:**

- **Unstable operation**

Explanation:

There is not enough power at the DC input of the inverter for stable operation. The inverter cannot connect to the utility grid.

Corrective measures:

- Ensure that the PV module is dimensioned correctly.
- Ensure that the PV module is not covered by snow or otherwise shaded.
- Ensure that the PV module is free of defects.

11.2.27 Event 3501**⚠ QUALIFIED PERSON****Event message:**

- **Insulation failure**
- **Check generator**

Explanation:

The inverter has detected a ground fault in the PV module.

Corrective measures:

- Check the PV system for ground faults.

11.2.28 Event 3601**⚠ QUALIFIED PERSON****Event message:**

- **High discharge current**
- **Check generator**

Explanation:

The leakage current of the inverter and the PV module is too high. There is a ground fault, a residual current or a malfunction.

The inverter interrupts feed-in operation immediately after exceeding a threshold. When the fault is eliminated, the inverter automatically reconnects to the utility grid.

Corrective measures:

- Check the PV system for ground faults.

11.2.29 Event 3701

QUALIFIED PERSON

Event message:

- **Residual current too high**
- **Check generator**

Explanation:

The inverter has detected a residual current through brief grounding of the PV module.

Corrective measures:

- Check the PV system for ground faults.

11.2.30 Event 3801

QUALIFIED PERSON

Event message:

- **Residual current too high**
- **Check generator**

Explanation:

Overcurrent at the DC input. The inverter briefly interrupts feed-in operation.

Corrective measures:

- If this message is displayed frequently, ensure that the PV module has been correctly rated and wired.

11.2.31 Event 3802

QUALIFIED PERSON

Event message:

- **Residual current too high**
- **Check generator**

Explanation:

Overcurrent at the DC input. The inverter briefly interrupts feed-in operation.

Corrective measures:

- If this message is displayed frequently, ensure that the PV module has been correctly rated and wired.

11.2.32 Event 3805**⚠ QUALIFIED PERSON****Event message:**

- **Residual current too high**
- **Check generator**

Explanation:

Overcurrent at the DC input. The inverter briefly interrupts feed-in operation.

Corrective measures:

- If this message is displayed frequently, ensure that the PV module has been correctly rated and wired.

11.2.33 Event 3901**⚠ QUALIFIED PERSON****Event message:**

- **Waiting for DC start conditions**
- **Start conditions not met**

Explanation:

The feed-in conditions for the utility grid are not yet fulfilled.

Corrective measures:

- Ensure that the PV module is not covered by snow or otherwise shaded.
- Wait for higher irradiation.
- If this message is displayed frequently in the morning, increase the voltage limit for starting grid feed-in. Change the parameter **Critical voltage to start feed-in**.
- If this message is displayed frequently with medium irradiation, ensure that the PV module is correctly rated.

11.2.34 Event 3902**⚠ QUALIFIED PERSON****Event message:**

- **Waiting for DC start conditions**
- **Start conditions not met**

Explanation:

The feed-in conditions for the utility grid are not yet fulfilled.

Corrective measures:

- Ensure that the PV module is not covered by snow or otherwise shaded.
- Wait for higher irradiation.
- If this message is displayed frequently in the morning, increase the voltage limit for starting grid feed-in. Change the parameter **Critical voltage to start feed-in**.
- If this message is displayed frequently with medium irradiation, ensure that the PV module is correctly rated.

11.2.35 Event 3908

QUALIFIED PERSON

Event message:

- **Leakage current-carrying capacity of DC generator too high.**

Explanation:

The permissible residual current reaches or exceeds the threshold.

Corrective measures:

- If a residual-current device is installed, ensure that it is set correctly.
- Observe the behavior of the inverter and wait to see whether the inverter resumes operation on its own.
- Ensure that no insulation error is present and that the residual-current device is functional.

11.2.36 Event 4011

QUALIFIED PERSON

Event message:

- **Bridged strings determined**

Explanation:

The DC inputs A and B are connected in parallel.

11.2.37 Event 4012

QUALIFIED PERSON

Event message:

- **No bridged strings determined**

Explanation:

The DC inputs A and B are not connected in parallel.

11.2.38 Event 4301

QUALIFIED PERSON

Event message:

- **Serial el.arc in String |s0| detected by AFCI mod.**

Explanation:

The inverter has detected an electric arc in the displayed string. If "String N/A" is displayed, the string could not be uniquely assigned.

Corrective measures:

- Disconnect the inverter from all voltage sources.
- Check the PV modules and the cabling in the affected string or, if the string was not displayed, in all strings for damage.
- Ensure that the DC connection in the inverter is correct.
- Repair or replace defective PV modules, DC cables or the DC connection in the inverter.
- Start manual restart (if necessary).

11.2.39 Event 6001-6499

QUALIFIED PERSON

Event message:

- **Self-diagnosis**
- **Interference device**

Explanation:

The cause must be determined by the Service.

Corrective measures:

- Contact Service.

11.2.40 Event 6501

QUALIFIED PERSON

Event message:

- **Self-diagnosis**
- **Overtemperature**

Explanation:

The inverter has switched off due to excessive temperature.

Corrective measures:

- Clean the cooling fins on the rear of the enclosure and the air ducts on the top using a soft brush.
- Ensure that the inverter has sufficient ventilation.
- Ensure that the inverter is not exposed to direct solar irradiation.
- Ensure the maximum ambient temperature is not exceeded.

11.2.41 Event 6502

⚠ QUALIFIED PERSON**Event message:**

- **Self-diagnosis**
- **Overtemperature**

Explanation:

The inverter has switched off due to excessive temperature.

Corrective measures:

- Clean the cooling fins on the rear of the enclosure and the air ducts on the top using a soft brush.
- Ensure that the inverter has sufficient ventilation.
- Ensure that the inverter is not exposed to direct solar irradiation.
- Ensure that the maximum permissible ambient temperature is complied with.

11.2.42 Event 6509

⚠ QUALIFIED PERSON**Event message:**

- **Self-diagnosis**
- **Overtemperature**

Explanation:

The inverter has switched off due to excessive temperature.

Corrective measures:

- Clean the cooling fins on the rear of the enclosure and the air ducts on the top using a soft brush.
- Ensure that the inverter has sufficient ventilation.
- Ensure that the inverter is not exposed to direct solar irradiation.
- Ensure the maximum ambient temperature is not exceeded.

11.2.43 Event 6512

Event message:

- **Minimum operating temperature not reached**

Explanation:

The inverter will only recommence grid feed-in once the temperature has reached at least -25°C .

11.2.44 Event 6603

⚠ QUALIFIED PERSON**Event message:**

- **Self-diagnosis**
- **Overcurrent grid (HW)**

Explanation:

The cause must be determined by the Service.

Corrective measures:

- Contact Service.

11.2.45 Event 6604

⚠ QUALIFIED PERSON**Event message:**

- **Self-diagnosis**
- **Overvoltage intermediate circuit (SW)**

Explanation:

The cause must be determined by the Service.

Corrective measures:

- Contact Service.

11.2.46 Event 6801

⚠ QUALIFIED PERSON**Event message:**

- **Self-diagnosis**
- **Input A defective**

Explanation:

Polarity error on the inverter.

Corrective measures:

- Check whether a string is connected to input A.
- Contact Service.

11.2.47 Event 6802

⚠ QUALIFIED PERSON**Event message:**

- **Self-diagnosis**
- **Input A defective**

Explanation:

Polarity error on the inverter.

Corrective measures:

- Check whether a string is connected to input A.
- Contact Service.

11.2.48 Event 6901

⚠ QUALIFIED PERSON**Event message:**

- **Self-diagnosis**
- **Input B defective**

Explanation:

Polarity error on the inverter.

Corrective measures:

- Check whether a string is connected to input B.
- Contact Service.

11.2.49 Event 6902

⚠ QUALIFIED PERSON**Event message:**

- **Self-diagnosis**
- **Input B defective**

Explanation:

Polarity error on the inverter.

Corrective measures:

- Check whether a string is connected to input B.
- Contact Service.

11.2.50 Event 7001

⚠ QUALIFIED PERSON**Event message:**

- **Fault sensor interior temperature**

Explanation:

A temperature sensor in the inverter is defective and the inverter interrupts the feed-in operation. The cause must be determined by the Service.

Corrective measures:

- Contact Service.

11.2.51 Event 7002

⚠ QUALIFIED PERSON**Event message:**

- **Fault sensor interior temperature**

Explanation:

A temperature sensor in the inverter is defective and the inverter interrupts the feed-in operation. The cause must be determined by the Service.

Corrective measures:

- Contact Service.

11.2.52 Event 7701

⚠ QUALIFIED PERSON**Event message:**

- **Self-diagnosis**
- **Interference device**

Explanation:

The cause must be determined by the Service.

Corrective measures:

- Contact Service.

11.2.53 Event 7702

QUALIFIED PERSON

Event message:

- Self-diagnosis
- Interference device

Explanation:

The cause must be determined by the Service.

Corrective measures:

- Contact Service.

11.2.54 Event 7703

QUALIFIED PERSON

Event message:

- Self-diagnosis
- Interference device

Explanation:

The cause must be determined by the Service.

Corrective measures:

- Contact Service.

11.2.55 Event 8003

QUALIFIED PERSON

Event message:

- Temperature derating

Explanation:

The inverter has reduced its power output for more than 10 minutes due to excessive temperature.

Corrective measures:

- Clean the cooling fins on the rear of the enclosure and the air ducts on the top using a soft brush.
- Ensure that the inverter has sufficient ventilation.
- Ensure the maximum ambient temperature is not exceeded.
- Ensure that the inverter is not exposed to direct solar irradiation.

11.2.56 Event 8204

QUALIFIED PERSON

Event message:

- AFCI self-test failed

Explanation:

An error occurred during the self-test of SMA ArcFix. It is not guaranteed that SMA ArcFix will function correctly. The device does not feed in.

Corrective measures:

- Contact Service.

11.2.57 Event 8205

QUALIFIED PERSON

Event message:

- AFCI self-test successful

Explanation:

The self-test of SMA ArcFix has been completed successfully.

11.2.58 Event 8708

QUALIFIED PERSON

Event message:

- Timeout in communication for active power limitation

Explanation:

Communication to the system control absent. Depending on the fallback setting, either the last received values will be retained or the active power will be limited to the set percentage value of the inverter nominal power.

Corrective measures:

- Ensure that the connection to the System Manager is intact and that no cables are damaged or that no plugs have been pulled.

11.2.59 Event 8709

QUALIFIED PERSON

Event message:

- Timeout in communication for reactive power spec.

Explanation:

Communication to the system control absent.

Corrective measures:

- Ensure that the connection to the System Manager is intact and that no cables are damaged or that no plugs have been pulled.

11.2.60 Event 8710

QUALIFIED PERSON

Event number:

- **Timeout in communication for cos-Phi spec.**

Explanation:

Communication to the system control absent.

Corrective measures:

- Ensure that the connection to the System Manager is intact and that no cables are damaged or that no plugs have been pulled.

11.2.61 Event 9002

QUALIFIED PERSON

Event message:

- **Installer code invalid**

Explanation:

The SMA Grid Guard code entered is incorrect. The operating parameters are still protected and cannot be changed.

Corrective measures:

- Enter the correct SMA Grid Guard code.

11.2.62 Event 9003

QUALIFIED PERSON

Event message:

- **Grid parameter locked**

Explanation:

Changes to the grid parameters are now blocked. In order to be able to make changes to the grid parameters, from now on you must log in using the SMA Grid Guard code.

Corrective measures:

- Log in as **Installer** and enter the SMA Grid Guard code.

11.2.63 Event 9007

⚠ QUALIFIED PERSON**Event message:**

- **Abort self-test**

Explanation:

The self-test was terminated.

Corrective measures:

- Ensure that the AC connection is correct.
- Ensure that the country data set has been entered correctly.
- Restart the self-test.

11.2.64 Event 10102

Display text:

Parameter |In04| set successfully

Description:

This message is issued at the beginning of a measurement.

11.2.65 Event 10431

Event message:

- **I-V curve measurement was successful**

Explanation:

This message is issued at the end of a measurement.

11.2.66 Event 29001

⚠ QUALIFIED PERSON**Event message:**

- **SMA Grid Guard code valid**

Explanation:

The entered SMA Grid Guard code is valid. The parameters protected with the SMA Grid Guard code can now be set.

11.3 Checking the PV System for Ground Faults

QUALIFIED PERSON

A ground fault may be present if the inverter beeps, the red LED lights up and the event numbers 3501, 3601 or 3701 are being displayed in the **Results** menu on the inverter user interface. The electrical insulation from the PV system to ground is defective or insufficient.

DANGER

Danger to life due to electric shock when touching live system components in case of a ground fault

If a ground fault occurs, parts of the system may still be live. Touching live parts and cables results in death or lethal injuries due to electric shock.

- Disconnect the product from voltage sources and ensure it cannot be reconnected before working on the device.
- Only touch the cables of the PV modules on their insulation.
- Do not touch any parts of the substructure or frame of the PV array.
- Do not connect PV strings with ground faults to the inverter.

WARNING

Danger to life due to electric shock from destruction of the measuring device due to overvoltage

Overvoltage can damage a measuring device and result in voltage being present in the enclosure of the measuring device. Touching the live enclosure of the measuring device results in death or lethal injuries due to electric shock.

- Only use measuring devices with a DC input voltage range of 600 V or higher.

Procedure:

In order to check the PV system for ground faults, perform the following actions in the prescribed order. The exact procedure is described in the following sections.

- Check the PV system for ground faults by measuring the voltage.
- If the voltage measurement was not successful, check the PV system via insulation resistance measurement for ground faults.

Test by Measuring the Voltage

Proceed as follows to check each string in the PV system for ground faults.

Procedure:

1.

DANGER

Danger to life due to high voltages

- Disconnect the inverter from all voltage sources (see Section 9, page 77).

2. Measure the voltage between the positive terminal and the ground potential (PE).

3. Measure the voltage between the negative terminal and the ground potential (PE).
4. Measure the voltage between the positive and negative terminals.
5. If the following results are present at the same time, there is a ground fault in the PV system:
 - All measured voltages are stable.
 - The sum of the two voltages to ground potential is approximately equal to the voltage between the positive and negative terminals.
6. If a ground fault is present, determine the location of the ground fault via the ratio of the two measured voltages and eliminate the ground fault.
7. If a definite ground fault cannot be measured and the message is still displayed, measure the insulation resistance.
8. Reconnect the strings without ground faults to the inverter and recommission the inverter (see inverter installation inverter).



Location of the ground fault

The example shows a ground fault between the second and third PV module.

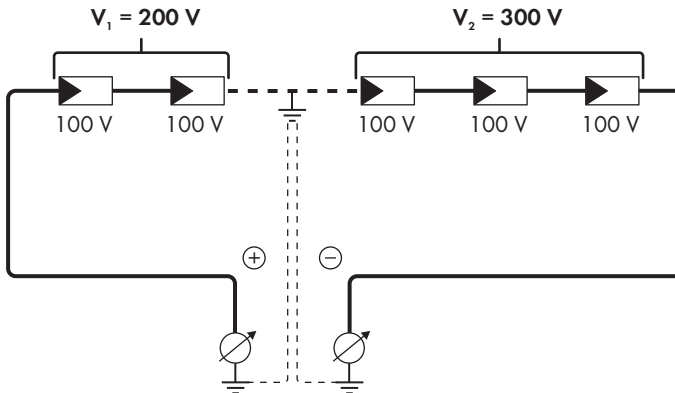

Test by Measuring the Insulation Resistance

If the voltage measurement does not provide sufficient evidence of a ground fault, the insulation resistance measurement can provide more exact results.

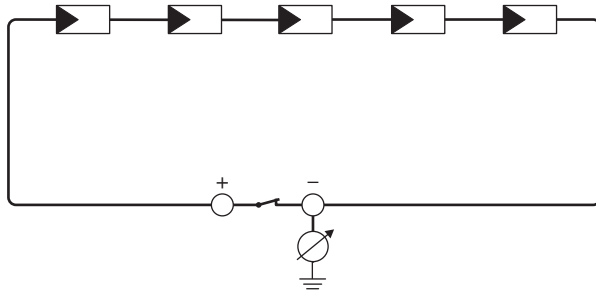

Figure 16: Schematic diagram of the measurement

i Calculating the insulation resistance

The expected total resistance of the PV system or of an individual string can be calculated using the following formula:

total

The exact insulation resistance of a PV module can be obtained from the module manufacturer or the datasheet.

For the resistance of a PV module an average value can be assumed: for thin-film PV modules approximately 40 MOhm and for polycrystalline and monocrystalline PV modules approximately 50 MOhm per PV module (for further information on calculating the insulation resistance see the Technical Information "Insulation Resistance (Riso) of Non-Galvanically Isolated PV Systems" at www.SMA-Solar.com).

Required devices:

- Suitable device for safe disconnection and short-circuiting
- Measuring device for insulation resistance

i Device required for safe disconnection and short-circuiting of the PV modules

The insulation resistance can only be measured with a suitable device for safe disconnection and short-circuiting of the PV modules. If no suitable device is available, the insulation measurement must not be carried out.

Procedure:

1. Calculate the expected insulation resistance per string.

2.

⚠ DANGER

Danger to life due to high voltages

- Disconnect the inverter from all voltage sources (see Section 9, page 77).

3. Install the short circuit device.
4. Connect the measuring device for insulation resistance.

5. Short-circuit the first string.
6. Set the test voltage. The test voltage should be as close as possible to the maximum system voltage of the PV modules but must not exceed it (see datasheet of the PV modules).
7. Measure the insulation resistance.
8. Eliminate the short circuit.
9. Measure the remaining strings in the same manner.
 - ☑ If the insulation resistance of a string deviates considerably from the theoretically calculated value, there is a ground fault present in that string.
10. Reconnect to the inverter only those strings from which the ground fault has been eliminated.
11. Reconnect all other strings to the inverter.
12. Recommission the inverter.
13. If the inverter still displays an insulation error, contact the Service (see Section 14, page 119). The PV modules might not be suitable for the inverter in the present quantity.

11.4 Problems with streaming services

If you use the streaming service in your local network (in which the inverter is also included), there may be interference to the transfer of data. In this case, the IGMP settings of the inverter can be changed via operating parameters.

- Contact the Service and change IGMP settings in consultation with the Service department.

12 Decommissioning the Inverter

⚠ QUALIFIED PERSON

To decommission the inverter completely upon completion of its service life, proceed as described in this Section.

⚠ CAUTION

Risk of injury due to weight of product

Injuries may result if the product is lifted incorrectly or dropped while being transported or mounted.

- Transport and lift the product carefully. Take the weight of the product into account.
- Wear suitable personal protective equipment for all work on the product.

Procedure:

1.

⚠ DANGER

Danger to life due to high voltages

- Disconnect the inverter from all voltage sources (see Section 9, page 77).

2.

⚠ CAUTION

Risk of burns due to hot enclosure parts

- Wait 30 minutes for the enclosure to cool down.

3. Unscrew the RS485 plug and pull it out of the jack.

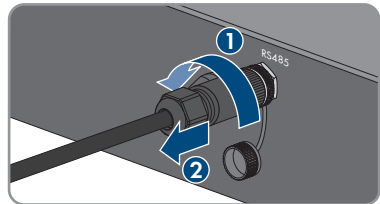

4. Screw the protective cap onto the RS485 jack.

5. Unscrew the swivel nut from the threaded sleeve for the network cable.

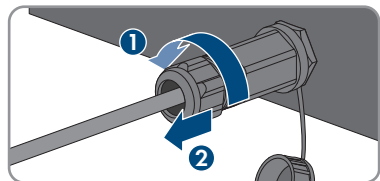

6. Unscrew and remove the threaded sleeve from the network port thread on the inverter.

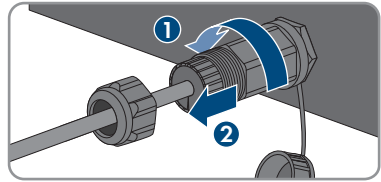

7. Release the network cable plug and pull it out of the jack on the inverter.

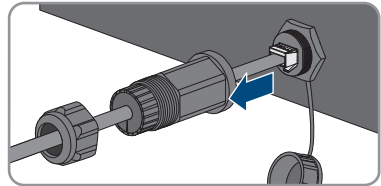

8. Take the cable support sleeve out of the threaded sleeve and remove the network cable from the cable support sleeve.

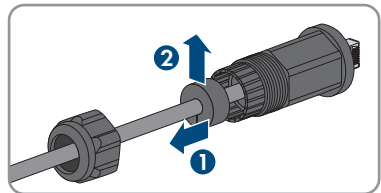

9. Lead the network cable out of the threaded sleeve and the swivel nut.

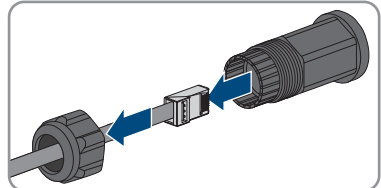

10. Screw the protective cap onto the network port.

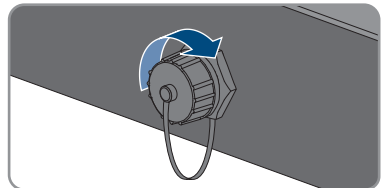

11. Unscrew and remove the antenna.

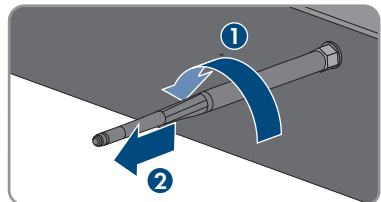

12. If there is a protective cap available, plug the protective cap onto the jack for connecting the antenna.

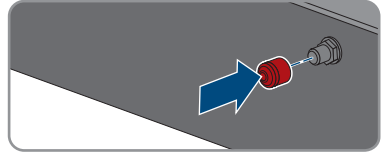

13. If an additional grounding or an equipotential bonding is connected to the inverter, unscrew the pan head screw M5x12 (TX25) and remove the grounding cable.

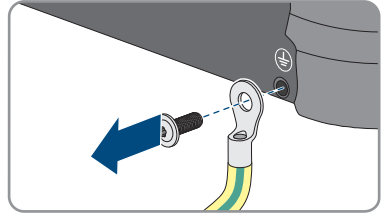

14. Unscrew the left- and right-hand pan head screws M5x12 used to secure the inverter to the wall mounting bracket (TX25).

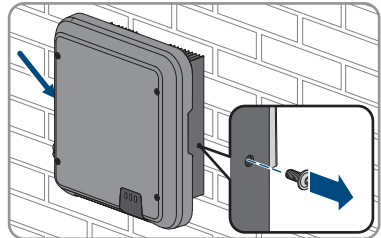

15. Remove the inverter by lifting it vertically up and off the wall mounting bracket.

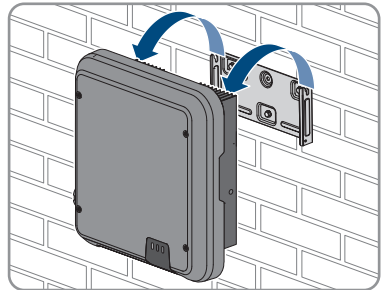

16. Unscrew the screws for fastening the wall mounting bracket and remove the wall mounting bracket.

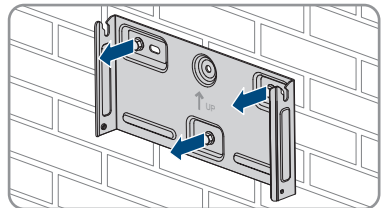

17. If the inverter is to be stored or shipped, pack the inverter, the AC connector, the DC connector, the RJ45 protective sleeve, the antenna and the wall mounting bracket. Use the original packaging or packaging that is suitable for the weight and dimensions of the inverter.
18. Dispose of the inverter in accordance with the locally applicable disposal regulations for electronic waste.

13 Technical Data

13.1 DC/AC

13.1.1 Sunny Boy 3.0 / 3.6 / 4.0

DC input

	SB3.0-1AV-41	SB3.6-1AV-41	SB4.0-1AV-41
Maximum power of PV array	5500 Wp	5500 Wp	7500 Wp
Maximum input voltage	600 V	600 V	600 V
MPP voltage range	110 V to 500 V	130 V to 500 V	140 V to 500 V
Rated input voltage	365 V	365 V	365 V
Minimum input voltage	100 V	100 V	100 V
Initial input voltage	125 V	125 V	125 V
Maximum input current, input A	15 A	15 A	15 A
Maximum input current, input B	15 A	15 A	15 A
Maximum input current per string, input A	15 A	15 A	15 A
Maximum input current per string, input B	15 A	15 A	15 A
Maximum short-circuit current, input A ¹⁾	20 A	20 A	20 A
Maximum short-circuit current, input B ¹⁾	20 A	20 A	20 A
Maximum reverse current into the PV modules	0 A	0 A	0 A
Number of independent MPP inputs	2	2	2
Strings per MPP input	2	2	2
Overvoltage category as per IEC 60664-1	II	II	II

¹⁾ In accordance with IEC 62109-2: $I_{SC,PV}$

AC output

	SB3.0-1AV-41	SB3.6-1AV-41	SB4.0-1AV-41
Rated power at 230 V, 50 Hz	3000 W	3680 W	4000 W
Maximum apparent power at $\cos \varphi = 1$	3000 VA	3680 VA	4000 VA
Rated apparent power at $\cos \varphi = 1$	3000 VA	3680 VA	4000 VA
Nominal grid voltage	220 V / 230 V / 240 V	220 V / 230 V / 240 V	220 V / 230 V / 240 V
Rated grid voltage	230 V	230 V	230 V
Voltage range ²⁾	180 V to 280 V	180 V to 280 V	180 V to 280 V
Rated current at 220 V	13.7 A	16 A	18.2 A
Rated current at 230 V	13.1 A	16 A	17.4 A
Rated current at 240 V	12.5 A	15.4 A	16.7 A
Maximum output current	13.7 A	16 A	18.2 A
Total harmonic distortion of the output current with total harmonic distortion of the AC voltage <2%, and AC power >50% of the rated power	≤3 %	≤3 %	≤3 %
Maximum output current under fault conditions	29 A	29 A	29 A
Inrush current	< 20% of the nominal AC current for a maximum of 10 ms	< 20% of the nominal AC current for a maximum of 10 ms	< 20% of the nominal AC current for a maximum of 10 ms
Rated grid frequency	50 Hz	50 Hz	50 Hz
Grid frequency ²⁾	50 Hz / 60 Hz	50 Hz / 60 Hz	50 Hz / 60 Hz
Operating range at grid frequency 50 Hz	45 Hz to 55 Hz	45 Hz to 55 Hz	45 Hz to 55 Hz
Operating range at grid frequency 60 Hz	55 Hz to 65 Hz	55 Hz to 65 Hz	55 Hz to 65 Hz

²⁾ Depending on the configured country data set

	SB3.0-1AV-41	SB3.6-1AV-41	SB4.0-1AV-41
Power factor at rated power	1	1	1
Displacement power factor $\cos \varphi$, adjustable	0.8 overexcited to 0.8 underexcited	0.8 overexcited to 0.8 underexcited	0.8 overexcited to 1 to 0.8 underexcited
Feed-in phases	1	1	1
Connection phases	1	1	1
Overvoltage category as per IEC 60664-1	III	III	III

Efficiency

	SB3.0-1AV-41	SB3.6-1AV-41	SB4.0-1AV-41
Maximum efficiency, η_{\max}	97.0 %	97.0 %	97.0 %
European weighted efficiency, η_{EU}	96.4 %	96.5 %	96.5 %

13.1.2 Sunny Boy 5.0 / 6.0

DC input

	SB5.0-1AV-41	SB6.0-1AV-41
Maximum power of PV array	7500 W _p	9000 W _p
Maximum input voltage	600 V	600 V
MPP voltage range	175 V to 500 V	210 V to 500 V
Rated input voltage	365 V	365 V
Minimum input voltage	100 V	100 V
Initial input voltage	125 V	125 V
Maximum input current, input A	15 A	15 A
Maximum input current, input B	15 A	15 A
Maximum input current per string, input A	15 A	15 A
Maximum input current per string, input B	15 A	15 A
Maximum short-circuit current, input A ³⁾	20 A	20 A

³⁾ In accordance with IEC 62109-2: $I_{\text{SC PV}}$

	SB5.0-1AV-41	SB6.0-1AV-41
Maximum short-circuit current, input B ³⁾	20 A	20 A
Maximum reverse current into the PV modules	0 A	0 A
Number of independent MPP inputs	2	2
Strings per MPP input	2	2
Overvoltage category as per IEC 60664-1	II	II

AC output

	SB5.0-1AV-41	SB6.0-1AV-41
Rated power at 230 V, 50 Hz ⁴⁾	5000 W	6000 W
Maximum apparent power at $\cos \varphi = 1$ ⁵⁾	5000 VA	6000 VA
Rated apparent power at $\cos \varphi = 1$ ⁵⁾	5000 VA	6000 VA
Nominal grid voltage	220 V / 230 V / 240 V	220 V / 230 V / 240 V
Rated grid voltage	230 V	230 V
Voltage range ⁶⁾	180 V to 280 V	180 V to 280 V
Rated current at 220 V	22.8 A	26.1 A
Rated current at 230 V	22 A	26.1 A
Rated current at 240 V	21 A	25 A
Maximum output current ⁷⁾	22.8 A	26.1 A
Total harmonic distortion of the output current with total harmonic distortion of the AC voltage <2%, and AC power >50% of the rated power	≤3 %	≤3 %
Maximum output current under fault conditions	29 A	29 A
Inrush current	< 20% of the nominal AC current for a maximum of 10 ms	< 20% of the nominal AC current for a maximum of 10 ms
Rated grid frequency	50 Hz	50 Hz

⁴⁾ According to VDE-AR-N 4105, the rated power at 230 V, 50 Hz of the SB5.0-1AV-41 is 4600 W

⁵⁾ According to VDE-AR-N 4105, the rated power at 230 V, 50 Hz of the SB5.0-1AV-41 is 4600 VA

⁶⁾ Depending on the configured country data set

⁷⁾ In accordance with IEC 62109-2: $I_{SC, PV}$

	SB5.0-1AV-41	SB6.0-1AV-41
Grid frequency ⁶⁾	50 Hz / 60 Hz	50 Hz / 60 Hz
Operating range at grid frequency 50 Hz	45 Hz to 55 Hz	45 Hz to 55 Hz
Operating range at grid frequency 60 Hz	55 Hz to 65 Hz	55 Hz to 65 Hz
Power factor at rated power	1	1
Displacement power factor $\cos \varphi$, adjustable	0.8 overexcited to 1 to 0.8 underexcited	0.8 overexcited to 0.8 underexcited
Feed-in phases	1	1
Connection phases	1	1
Overvoltage category as per IEC 60664-1	III	III

Efficiency

	SB5.0-1AV-41	SB6.0-1AV-41
Maximum efficiency, η_{\max}	97.0 %	97.0 %
European weighted efficiency, η_{EU}	96.5 %	96.6 %

13.2 General Data

Width x height x depth	435 mm x 470 mm x 176 mm
Weight	17.5 kg
Length x width x height of the packaging	495 mm x 595 mm x 250 mm
Transport weight	20.5 kg
Climatic category in accordance with IEC 60721-3-4	4K4H
Environmental category	outdoors
Pollution degree outside the enclosure	3
Pollution degree inside the enclosure	2
Operating temperature range	-25 °C to +60 °C
Max. permissible value for relative humidity (condensing)	100 %
Maximum operating altitude above mean sea level (MSL)	3000 m
Typical noise emission	25 dB(A)
Power loss in night mode	5 W
Maximum data volume per inverter with Speed-wire/Webconnect	550 MB/month

Additional data volume when using the Sunny Portal live interface	660 kB/hour
Power control / Demand response (DRED)	Communication via Modbus interface
Export limiting in accordance with AS/NZS 4777.2	EMETER-20, HM-20
Demand response mode in accordance with AS/NZS 4777.2	DRM0
Topology	Transformerless (Non-isolated)
Cooling method	Convection
Degree of protection for electronics in accordance with IEC 60529	IP65
Protection class in accordance with IEC 62109-1	I
Radio technology	WLAN 802.11 b/g/n
Radio spectrum	2.4 GHz
Maximum transmission power	100 mW
Quantity maximum detectable Wi-Fi networks	32
Grid configurations ⁸⁾	IT, Delta-IT, TN-C, TN-S, TN-C-S, TT (when $V_{N,PE} < 20 \text{ V}$)

13.3 Climatic Conditions

Installation in accordance with IEC 60721-3-3, Class 4K4H

Extended temperature range	-25 °C to +60 °C
Extended humidity range	0% to 100%
Extended air pressure range	79.5 kPa to 106 kPa

Transport in accordance with IEC 60721-3-2, Class 2K3

Temperature range	-25 °C to +70 °C
-------------------	------------------

13.4 Protective Devices

DC reverse polarity protection	Short-circuit diode
Input-side disconnection point	DC load-break switch ⁹⁾
AC short-circuit current capability	Current control

⁸⁾ **IT, Delta-IT:** When using in these systems, the grounding conductor monitoring must be deactivated and an additional grounding connected to the inverter.

⁹⁾ Usage category according to IEC 60947: DC-PV2

Grid monitoring	SMA Grid Guard 10.0
Maximal output overcurrent protection	32 A
Ground fault monitoring	Insulation monitoring: $R_{iso} > 200 \text{ k}\Omega$
All-pole sensitive residual-current monitoring unit	Available
Active anti-islanding method	Frequency shift

13.5 Equipment

DC connection	SUNCLIX DC connector
AC connection	AC connector
WLAN	As standard
SMA Speedwire/Webconnect	As standard
RS485	As standard

13.6 Torques

Screws for securing the inverter to the wall mounting bracket	2.5 Nm
Additional grounding	2.5 Nm
SUNCLIX swivel nut	2.0 Nm
Screw terminals of the AC connector	1.5 Nm \pm 0.3 Nm

13.7 Data Storage Capacity

Daily yields	30 years
Event messages for users	1024 events
Event messages for installers	1024 events

14 Contact

If you have technical problems with our products, please contact the SMA Service Line. The following data is required in order to provide you with the necessary assistance:

- Device type
- Serial number
- Firmware version
- Event message
- Installation site and mounting height
- Type and number of PV modules
- Optional equipment, e.g. communication products
- Use the name of the system in Sunny Portal (if available)
- Access data for Sunny Portal (if available)
- Special country-specific settings (if available)

You can find your country's contact information at:



<https://go.sma.de/service>

15 EU Declaration of Conformity

within the scope of the EU directives

- Radio Equipment Directive 2014/53/EU (22.5.2014 L 153/62) (RED)
- Restriction of the use of certain hazardous substances 2011/65/EU (L 174/88, June 8, 2011) and 2015/863/EU (L 137/10, March 31, 2015) (RoHS)



SMA Solar Technology AG confirms herewith that the products described in this document are in compliance with the fundamental requirements and other relevant provisions of the aforementioned directives. More information on the availability of the entire declaration of conformity can be found at <https://www.sma.de/en/ce-ukca>.

Radio technology	WLAN 802.11 b/g/n
Radio spectrum	2.4 GHz
Maximum transmission power	100 mW

16 UK Declaration of Conformity

according to the regulations of England, Wales and Scotland

- Electromagnetic Compatibility Regulations 2016 (SI 2016/1091)
- Electrical Equipment (Safety) Regulations 2016 (SI 2016/1101)
- Radio Equipment Regulations 2017 (SI 2017/1206)
- The Restriction of the Use of Certain Hazardous Substances in Electrical and Electronic Equipment Regulations 2012 (SI 2012/3032)



SMA Solar Technology AG confirms herewith that the products described in this document are in compliance with the fundamental requirements and other relevant provisions of the above-mentioned regulations. More information on the availability of the entire declaration of conformity can be found at <https://www.sma.de/en/ce-ukca>.

Radio technology	WLAN 802.11 b/g/n
Radio spectrum	2.4 GHz
Maximum transmission power	100 mW

SMA Solar UK Ltd.

Countrywide House
 23 West Bar, Banbury
 Oxfordshire, OX16 9SA
 United Kingdom



www.SMA-Solar.com

