

User Manual

Single-Phase Microinverter

About Microinverter

The Fox ESS M1-1200-E / 1000-E / 800-E / 600-E series microinverters are a series of one-to-two microinverters, each of which can be connected to two PV Modules. This series of microinverters can efficiently convert DC power to AC power that meets the grid requirements, and feed the power into the grid.

Each set of microinverter of the Fox ESS M1-1200-E / 1000-E / 800-E / 600-E series can operate independently, and monitor the power status of each PV Module in real time. This feature provides a high degree of flexibility and reliability, ensuring that each PV Module generates sufficient power.

About This Manual

This manual contains important notes on the **M1-1200-E / 1000-E / 800-E / 600-E** microinverters and should be read before installing or debugging the microinverters. For safety reasons, the technicians who are responsible for the installation, operation and maintenance of this microinverter must have corresponding qualifications, have received related trainings and grasp the related skills. The instructions contained in this manual must be followed strictly during installation, operation and maintenance.

Other Information

Product information is subject to change without prior notice. The User Manual will be updated regularly, please visit Fox ESS official website www.fox-ess.com to get the latest version.

Contents

1. Important Notes.....	1
1.1 Scope of Application.....	1
1.2 Target Audience.....	1
1.3 Safety Symbols	1
1.4 Radio Wave Interference Statement.....	2
2. Safety Notes	2
2.1 Important Safety Notes	2
2.2 Symbol Instructions	3
3. Product Introduction	4
3.1 Photovoltaic Grid-Connected System.....	4
3.2 Microinverter.....	5
3.3 One-to-Two System	5
3.4 AC Branch Capacity	6
3.5 Product Highlights.....	7
3.6 Terminal Instructions.....	7
3.7 Dimension	7
4. Installation Preparations	8
4.1 Position and Spacing Requirements.....	8
4.2 Installation Tools.....	8
4.3 Precautions.....	8
4.4 Microinverter System Overview.....	9
5. Microinverter Installation	11
5.1 Preparation	11
5.2 Installation Steps.....	13
6. Troubleshooting	22
6.1 Troubleshooting List.....	22
6.2 Status of LED Indicator	29
6.3 Field Inspection (Only Limited to the Qualified Installation Personnel)	29
6.4 Routine Maintenance	30
7. Equipment Disassembly	31
7.1 Disassembly Steps	31
7.2 Storage and Transportation	31
7.3 Scrapping and Disposal.....	32
8. Technical Specification	33
Appendix.....	35

1. Important Notes

1.1 Scope of Application

This manual mainly introduces the methods for assembling, installing, maintaining and troubleshooting of the microinverters of the following models:

- M1-1200-E
- M1-1000-E
- M1-800-E
- M1-600-E

Notice:



- “1200” refers to 1200 W, “1000” refers to 1000 W, “800” refers to 800 W, and “600” refers to 600 W.
- Advanced direct routing method is adopted in M1-1200-E / M1-1000-E / M1-800-E / M1-600-E, which can communicate with the direct routing via WIFI to achieve data interaction.

1.2 Target Audience

This manual is only for professional technicians. For safety reasons, the technicians who are responsible for the installation, operation and maintenance of this microinverter must have corresponding qualifications, have received related trainings and grasp the related skills. The instructions contained in this manual must be followed strictly during installation, operation and maintenance.

1.3 Safety Symbols

The safety symbols used in the User Manual are as follows:

Symbol	Instructions
	This symbol indicates a hazardous condition that may cause a fatal electric shock hazard, serious personal injury, or fire.
	This symbol indicates that in order to avoid potential safety hazards (e.g. equipment damage or personal injury), the corresponding notes must be followed
	This symbol indicates that this operation is prohibited. The person concerned should discontinue the operation and continue only with extreme caution and with full understanding of the operation described.

1.4 Radio Wave Interference Statement

This microinverter has been tested and found to comply with CE EMC related requirements and is not subject to electromagnetic interference. Please note that this product may cause electromagnetic interference if not installed properly.

The microinverter can be closed before restarting, to detect whether the radio or television reception is interfered by this equipment. If the equipment interferes the radio or television reception, please try to adopt the following measures to eliminate influences:

- 1) Adjust the installation position of antenna of other electric appliances.
- 2) Enlarge the distance between the microinverter and the antenna.
- 3) Separate the microinverter from the antenna using a shield such as metal/concrete material or a roof.
- 4) Seek for help from the local dealer or the experienced radio technicians.

2. Safety Notes



2.1 Important Safety Notes





M1-1200-E / M1-1000-E / M1-800-E / M1-600-E series microinverter strictly follow the international related safety standards for design and detection. However, during installation and use of this microinverter, all the instructions, precautions and warnings in the installation manual must be read and abided by.

<ul style="list-style-type: none">• All the operations, such as transportation, installation, starting and maintenance must be performed by the qualified and trained professionals.
<ul style="list-style-type: none">• Prior to installation, please check the product, to ensure that no damages occurred in the product during transportation. If it is damaged, the insulation performance or safety distance of microinverter may be affected. Please carefully selection installation position and abide by the specified cooling requirements. Unauthorized disassembly of necessary protection facilities, improper use and improper installation operations may lead to equipment damage, even lead to serious safety accidents or electric shock.
<ul style="list-style-type: none">• Before connecting the microinverter to the grid, please contact the local electric power department. It can only be connected to the grid with the permission of the electric power department. All the connection operations must be completed by the qualified technicians. The installation personnel must be responsible for providing the external isolating switch and the Over-Current Protective Devices (OCPD).
<ul style="list-style-type: none">• The microinverter connects one PV Module per input. Do not connect to batteries or other power sources. When using the microinverter, make sure that various parameters of the operating environment are within the range shown in the

technical specifications table.
<ul style="list-style-type: none"> • Please do not install this equipment in flammable, explosive, corrosive, extremely hot/cold or humid environments. Please do not use this equipment when the safety devices discontinue to operate in such environments.
<ul style="list-style-type: none"> • Always wear personal protective equipment such as protective gloves and goggles during installation.
<ul style="list-style-type: none"> • For non-standard installation conditions, please consult the manufacturer.
<ul style="list-style-type: none"> • In case that there are abnormalities during equipment operation, please do not use the equipment.
<ul style="list-style-type: none"> • In case that the equipment requiring repairing, please make sure to use the qualified parts. The related parts can only be used for the intended purpose, and installed by the authorized contractors or Fox ESS authorized service representative.
<ul style="list-style-type: none"> • Fox ESS may not bear any responsibilities for any liabilities caused by using the components produced by other manufacturers.
<ul style="list-style-type: none"> • When the microinverter is disconnected from the public grid, some parts may still be charged, so please take care not to electrocute yourself. Before touching the microinverter, make sure that the surface temperature of the equipment is safe and that the voltage potential of the entire equipment does not exceed the safe range.
<ul style="list-style-type: none"> • Fox ESS may not bear any responsibilities for any liabilities caused by improper operation.
<ul style="list-style-type: none"> • The electrical installation and maintenance works should be completed by electricians with corresponding certifications, and wiring should be carried out following the local corresponding regulations.

2.2 Symbol Instructions

Symbol	Purpose
	<p>Waste Disposal</p> <p>In order to comply with European Directive 2002/96/EC on end-of-life electrical and electronic equipment and its implementation as a matter of national law, electrical equipment that has reached the end of its useful life must be collected separately and sent to an approved collection and recycling plant. Any waste equipment must be returned to an authorized dealer or an approved collection and recycling plant.</p>
	<p>Note</p> <p>Please do not step in the scope 0.2 m around when the microinverter operates.</p>

	High Voltage Danger The high voltage generated by the microinverter may endanger life.
	Surface High Temperature This microinverter may become hot during operation, do not touch the metal surfaces.
	CE Marks This microinverter meets the low voltage standard of European Union.
	Please Read the Manual Firstly Before installation, operation and maintenance, please carefully read the installation manual firstly.

3. Product Introduction

3.1 Photovoltaic Grid-Connected System

The common photovoltaic grid-connected system consists of PV Modules, photovoltaic inverter, power meter, and power grid, as shown in the figure below. The PV Modules generate DC power, the photovoltaic inverter converts the DC power to AC power that meets the requirements of the grid, and the power meter feeds the converted AC power to the grid.

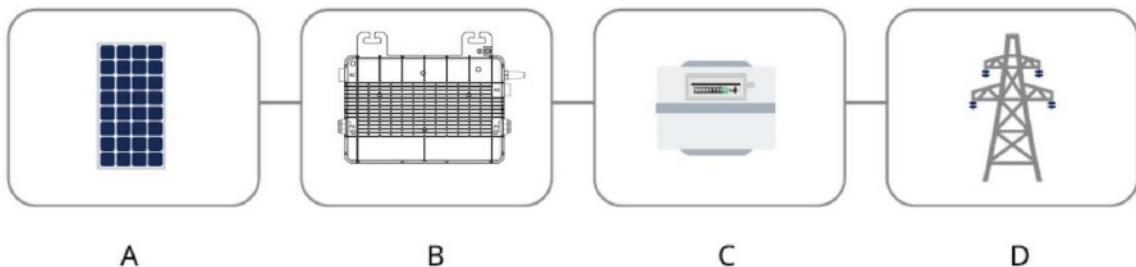

Items	Description
A	PV Modules
B	Photovoltaic inverter*
C	Grid-connected power meter equipment
D	Power grid

*Notice: In this system, the photovoltaic inverter is the microinverter M series developed and produced independently by our company. PV Modules are not within the range provided by our company.

3.2 Microinverter

The microinverter is a module-level photovoltaic inverter, which can effectively deal with single-point system failure in the photovoltaic generation system.

The Fox ESS M1-1200-E / M1-1000-E / M1-800-E / M1-600-E microinverter integrates the dual MPPT function, so that even if some single PV Modules fail to operate or suffer from shadowing, the other modules remain unaffected. This feature maximizes the power generation performance of the photovoltaic system in a cost-effective manner.

The microinverter is equipped with a module-level monitoring function that can monitor the current, voltage and power data of each module, and upload the data to the Fox ESS CLOUD platform via a router, allowing users to track the operating status of each module in real time and implement remote control.

In addition, DC voltage of the microinverter is only a few tens of volts (less than 65 V), which can minimize safety hazards.

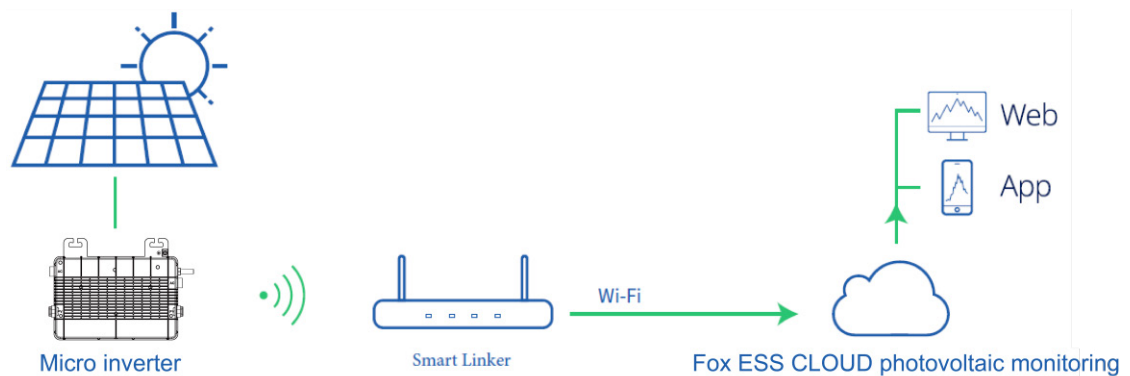

3.3 One-to-Two System

According to the number of connected PV Modules, the microinverter in this manual is a one-to-two series, i.e., the microinverter can be connected to two modules respectively, as shown in the figure below.

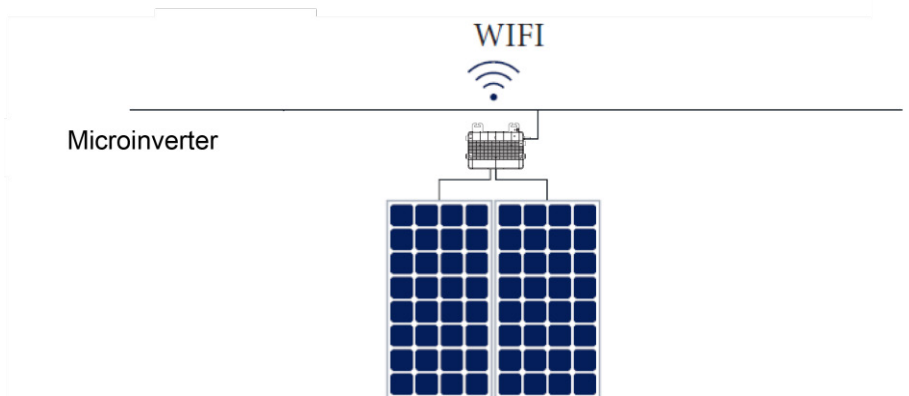

This Manual mainly introduces the Fox ESS one-to-two series microinverter. The output power of this series of microinverter is up to 1,200 VA, which performs excellently in the one-to-two series microinverter. Each set of microinverter can be connected to up to two PV Modules, equipping with dual MPPT and module-level data monitoring function, with higher power generating capacity and more convenient maintenance.

3.4 AC Branch Capacity

The Fox ESS M1-600-E / 800-E / 1000-E / 1200-E can be used with its own 12 AWG or 10 AWG AC bus with AC bus T-junctions. The number of microinverters that can be connected to each AC branch (12 AWG or 10 AWG) should not exceed the following limits.

Model	M1-600-E	M1-800-E	M1-1000-E	M1-1200-E	Maximum Over-Current Protection Device (OCPD)
Number of maximum microinverter that can be connected to each branch (10 AWG)	11	8	7	5	32A
Number of maximum microinverter that can be connected to each branch (12 AWG)	9	6	5	4	20A

Notice:

1. The number of microinverters that can be connected to each AC branch depends on the current-carrying capacity of the cable and joints.
2. As long as the total current does not exceed the amperage capacity specified by local regulations, the one-to-one, one-to-two and one-to-four series microinverters can be connected to the same AC branch.

3.5 Product Highlights

- The maximum output power is up to 600/800/1000/1200 W
- The peak efficiency is 96%
- The efficiency of static MPPT is up to 99.80%; and the efficiency of dynamic MPPT in cloudy weather is up to 99.76%.
- Power factor (adjustable) from 0.95 leading to 0.95 lagging
- WIFI direct connection/Mush networking communication, which is more cost-saving and convenient
- IP67 housing, 6,000 V surge protection, with higher reliability

3.6 Terminal Instructions

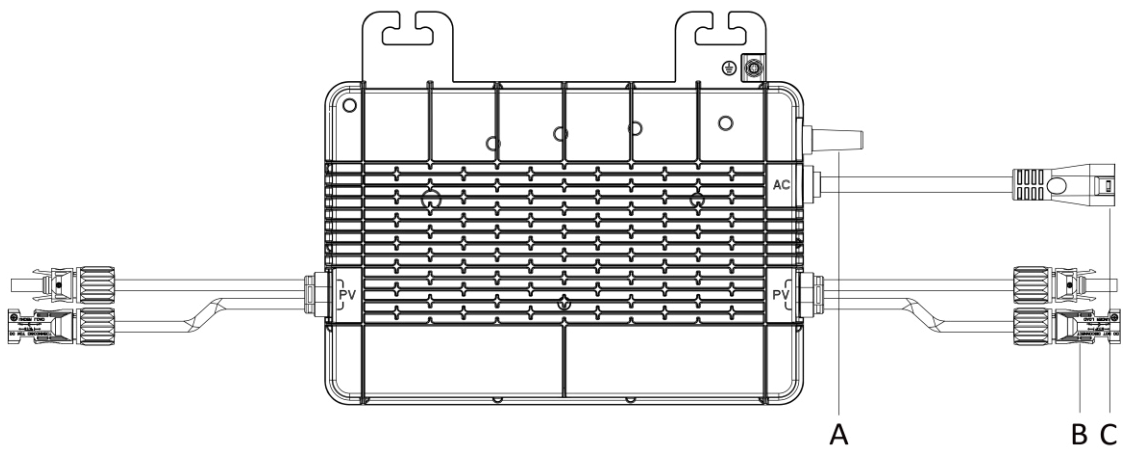

Items	Instruction
A	WIFI communication antenna
B	DC connector
C	AC branch connector

3.7 Dimension

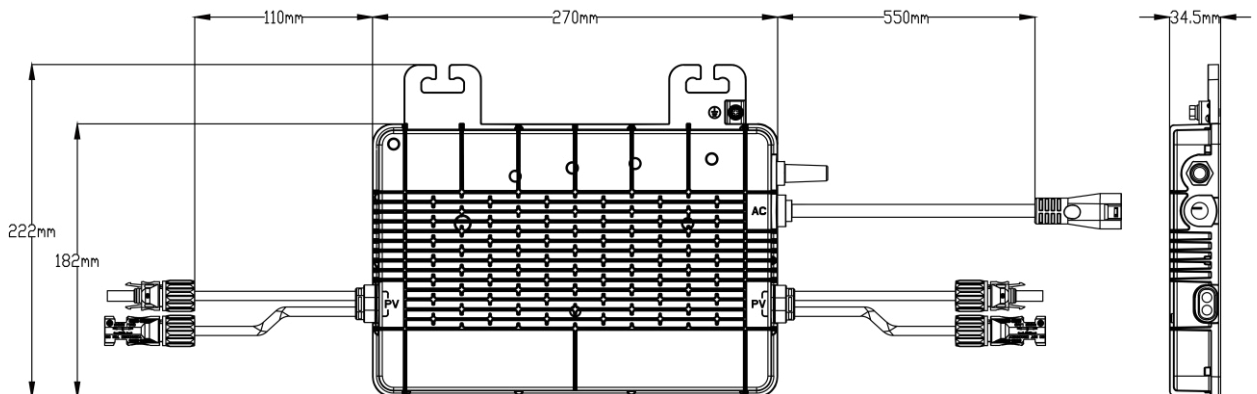

4. Installation Preparations

4.1 Position and Spacing Requirements

Please connect the microinverter and all the DCs below the PV Module, avoiding direct sunlight, rain, snow, ultraviolet irradiation, etc. Leave at least 2 cm of clearance around the housing of the microinverter to ensure ventilation and heat dissipation.

4.2 Installation Tools

Other auxiliary tools can also be used on site except the tools recommended below.

Screwdriver	Multimeter
Socket wrench or hex wrench	Marking pen
Diagonal cutting pliers	Steel measuring tape
Wire cutters	Cable tie
Wire stripper	Torque wrench and monkey wrench
Multi-purpose knife	

Protective gloves	Dust mask
Goggles	Insulated shoes

4.3 Precautions

The equipment shall be installed according the following system design requirements:

- During installation, the connection between the equipment and the grid must be cut off (disconnect the separating switches), with the PV Modules shielded or separated.
- Confirm that the environmental conditions are in accordance with the protection level, temperature, humidity, altitude, etc., as specified in the "Technical Specifications" section of the microinverter.
- Please do not expose the equipment in sunlight directly, to prevent power derating caused by internal overheat.
- The microinverter shall be installed in the places with good ventilation to avoid overheat.
- The microinverter shall be installed in the places away from the gas or flammable substances.
- During installation, electromagnetic interference should be avoided as much as possible, otherwise, the normal operation of electronic equipment may be affected.

The installation place shall meet the following conditions:

- Equipment such special support for device PV Modules (this kind of equipment are provided by the installation technicians).

- Please install the microinverter below the PV Modules, to ensure that it operates in shaded environment, otherwise, it may lead to reduction in generating capacity of the microinverter.

4.4 Microinverter System Overview

General rules:

1. The PV Modules shall be connected to the DC input port of the microinverter.
2. If the original cable is not long enough, please use the DC extension cable (less than 3 meters). Please consult the local electrical power operator to confirm that this DC cable meets the local regulations.

The Balcony-Single-Microinverter System

The Balcony-Single-Microinverter System wiring method are as shown in the figure below:

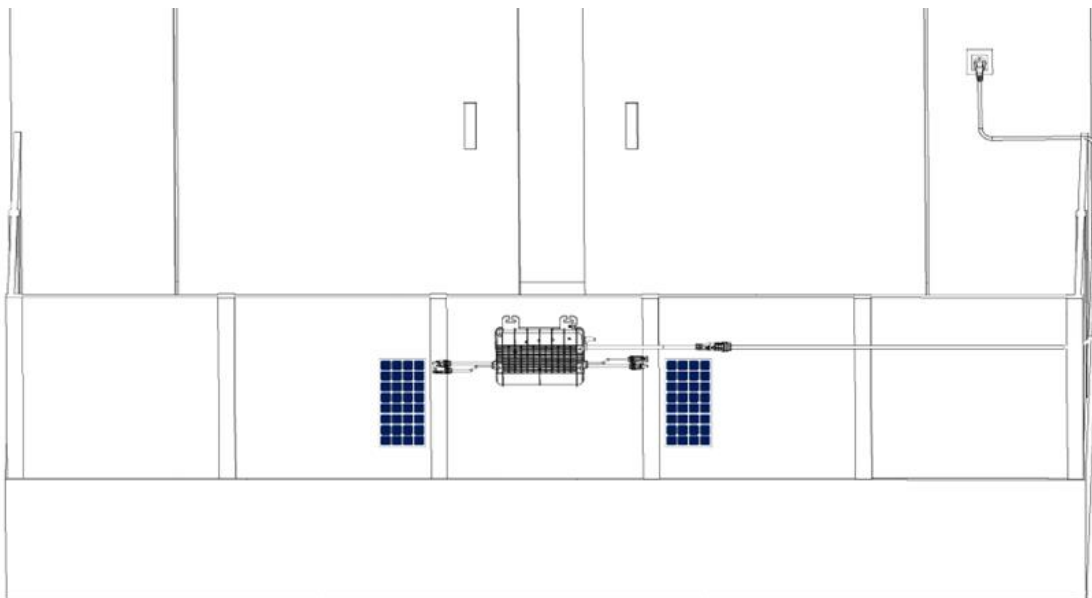

A balcony-single-microinverter system is a solar power setup with one microinverter and two PV modules, designed for installation on a balcony *.

In a single-microinverter system, you can connect the entire setup to the AC grid using the Plug and Play Cable.

*Notice: Balcony Area refers to areas with sufficient sunlight

The Multi-microinverter System

The Multi-microinverter System wiring method are as shown in the figure below:

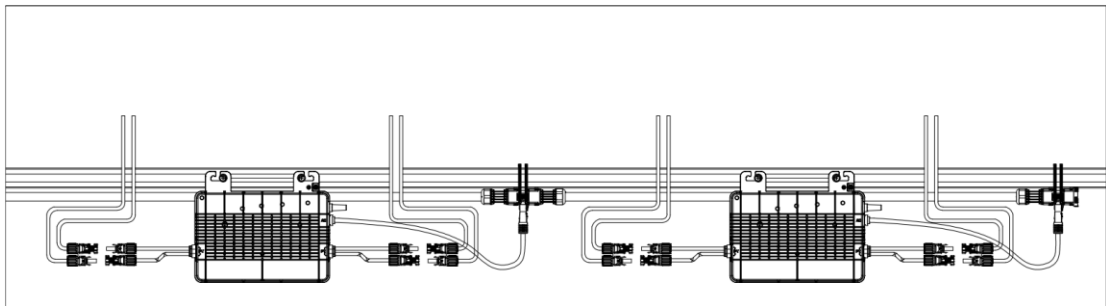

Notice:

Taking into account the influence of the local temperature extremes, the module voltage should not exceed the maximum input voltage of the microinverter, otherwise, the microinverter may be damaged (please refer to the "Technical Specifications" section to determine the maximum input voltage).

5. Microinverter Installation



5.1 Preparation

Unpacking the Box

The microinverter is thoroughly tested and strictly inspected before delivery. But damage may still occur during shipping.

After unpacking the microinverter, conduct a thorough inspection:

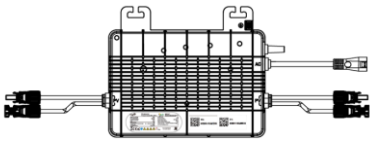
- Check for any external damage
- Check and confirm that all items are present

Container	Image
Microinverter	
Guide & Map	

Notice: Contact your supplier or distributor immediately if there are any damages or missing parts.

Checking the Parts

- **Single-Microinverter System**

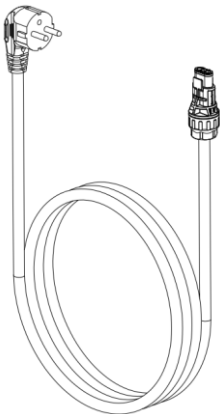

Plug and Play Cable

Notice:

This is an optional part. Please contact your local supplier to purchase.

• **Multi-Microinverter System**



A

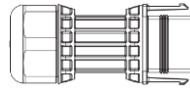

B

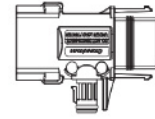

C



D



E

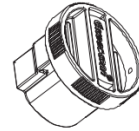

F



G

Item	Description	Item	Description
A	M8 * 25 screws (Prepared by the installer)	E	AC Trunk Disconnect Tool
B	AC Male connector	F	AC Trunk End Cap
C	AC Trunk Connector	G	AC Trunk Port Cap
D	AC Trunk Cable 12/10AWG Cable		

Notice: All accessories above are not included in the package and should be purchased separately.
Please contact your local supplier to purchase.

5.2 Installation Steps

• Single-Microinverter System

We offer following options for building a single-microinverter system:

Assembly Diagram

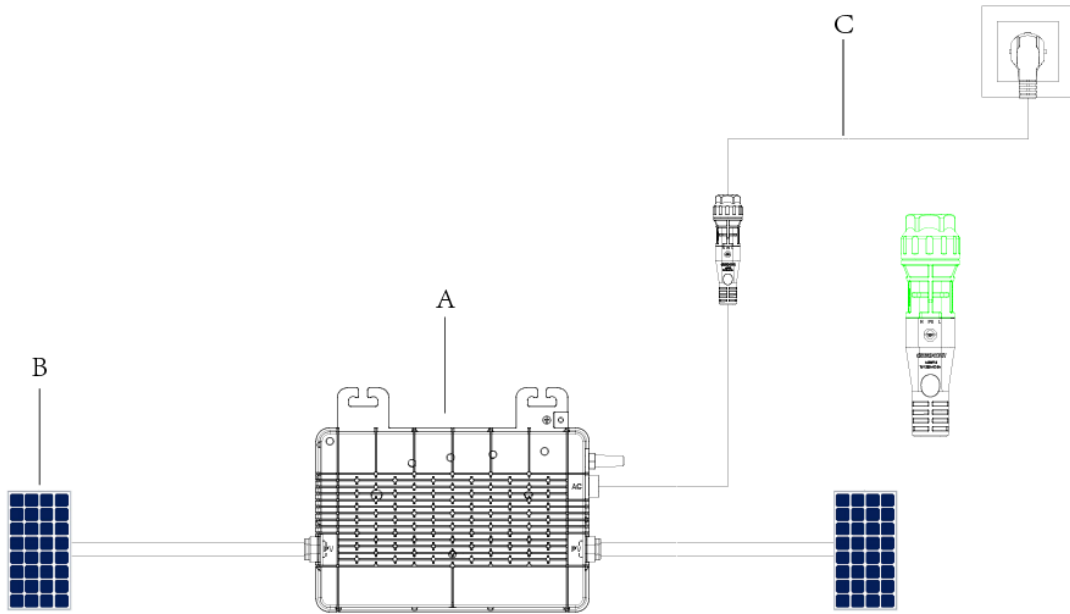

Position	Description
A	Microinverter
B	PV modules
C	Plug and Play Cable

Step 1 Position the Microinverter

- A) Plan and mark the position of the microinverter.
- B) Drill holes with an electrical drill



Step 2 Fix the Microinverter

- A) Mount and align the microinverter with the drilling holes
- B) Fix the microinverter with screws (Torque: 9 N·m).

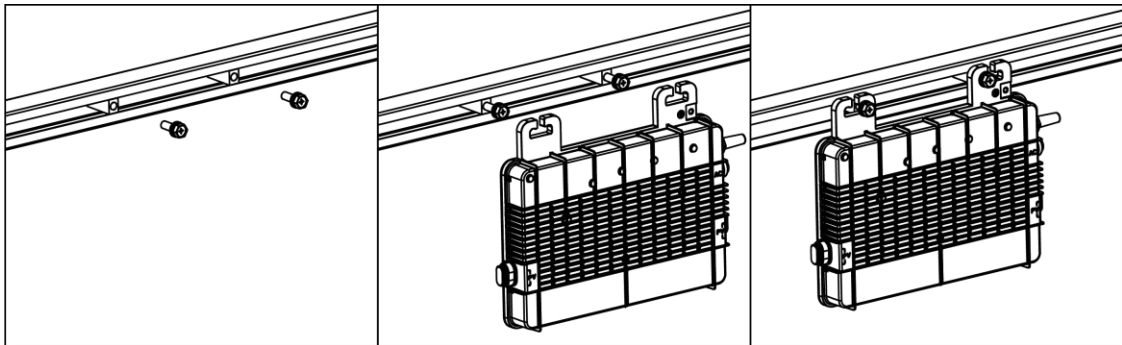

Step 3 Additional Grounding (if necessary)

The AC cable already includes an earth wire for direct grounding.
Use the grounding bracket on the right if external grounding is required.

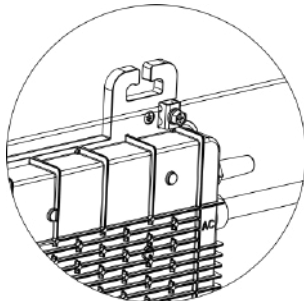

Notice:

Single microinverter systems offer flexible installation options, such as balconies, front lawns. Please note that the provided installation steps are for reference only, as the actual process may vary based on specific situations and local regulations.

Step 4 Plug-and-Play Connection

An Plug and Play Cable connects the microinverter to a socket. One end of the Plug and Play Cable directly connects to the microinverter, while the other end plugs into the socket. Your system will start to generate power in about two minutes.

Step 5 APP Installation

Scan the QR Code below to download and install the FoxCloud2.0 on your smartphone.



- **Multi-Microinverter System**

The order of Step 1 and Step 2 can be reversed according to your planned needs.

Step 1 Plan and Install the Microinverter

- Mark the position of each microinverter on the rail according to the PV module layout.
- Fix the screws on the rail.
- Hang the microinverter on the screws, and tighten the screws. The silver cover side of the microinverter should be facing the panel.

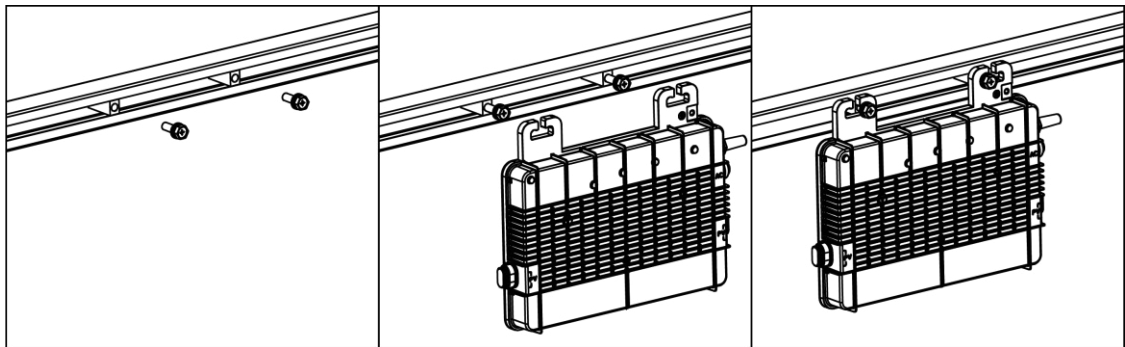

Notice:

1. There is an earth wire inside the wire cable and the grounding can be done directly by this wire. If external grounding is needed, the grounding electrode, as shown on the right, can be used to bond the mounting bracket to the racking. Torque each grounding cleat screw to 2 N•m.
2. Install the microinverter and all DC connections under the PV module to avoid direct sunlight, rain exposure, snow buildup, UV, etc.
3. Leave at least 2 cm of space around the microinverter enclosure to ensure ventilation and heat dissipation.
4. Mounting torque of the 8 mm screws should be 9 N • m. Please do not over-torque.
5. Do not pull or hold the AC cable with your hand.

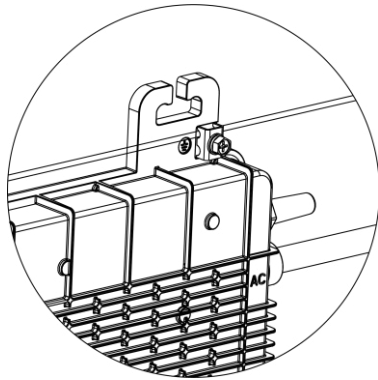

Step 2 Plan and build the AC Bus Cable

AC Trunk Cable is used to connect the microinverter to distribution box.

A) Select the appropriate AC Trunk Cable according to the spacing between microinverters. The connector spacing of the AC Trunk Cable should be close to spacing between microinverters to ensure that they are well-matched. (Fox-ess provides AC Trunk Cable with different AC Trunk Connector spacing.)

B) Determine how many microinverters you plan to install on each AC branch and prepare AC Trunk Connectors accordingly.

C) Take out segments of AC Trunk Cable as you need to make AC branch.

1) Installation of the AC bus (as shown)



2) Install the AC Trunk End Cap at one side of AC Trunk Cable (the end of AC Trunk Cable)

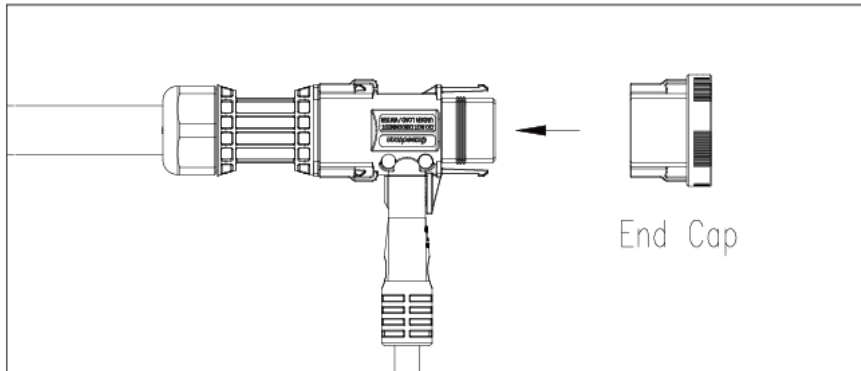

3) Install AC end cable on the other side of AC Trunk Cable (connected to the distribution box)

- Prepare a segment of AC cable with suitable length to connect to the distribution box, with stripping requirements fulfilled.

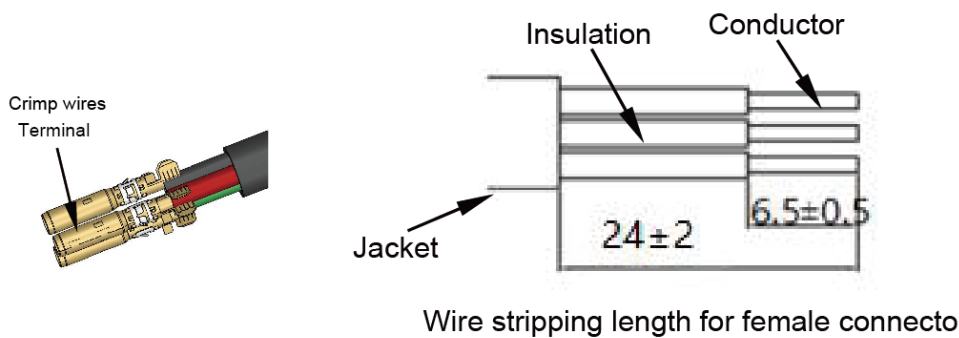

- Run the cable into the sleeve assembly.(AC Male connector)

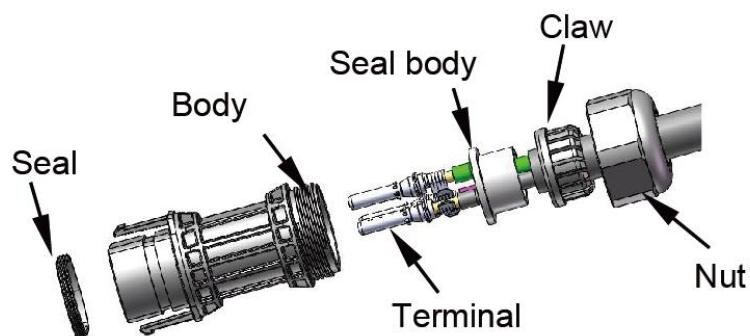

- Push the terminal into the body.(AC Male connector)

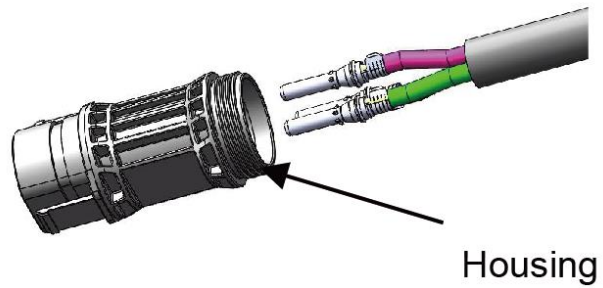

- Insert Seal and Clamp Finger into body ,then tighten the nut , torque $2.5\pm 0.5\text{N}\cdot\text{m}$

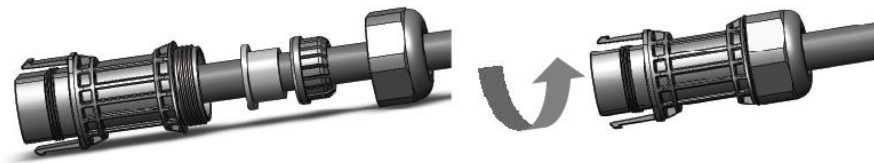

- Male and female connectors connected.

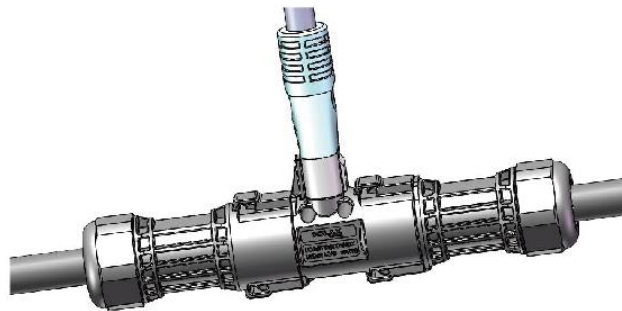

Notice:

1. Tightening torque of the cap: $2.0\pm 0.5\text{N}\cdot\text{m}$. Please do not over-torque.
2. Do not damage the sealing ring in the AC Trunk Connector during disassembly and assembly.

D) Repeat the above steps, lay out the cable on the rail as appropriate so that the microinverters can be connected to the Trunk connectors.

E) Attach the AC Trunk Cable to the mounting rail and fix the cable with tie wraps.

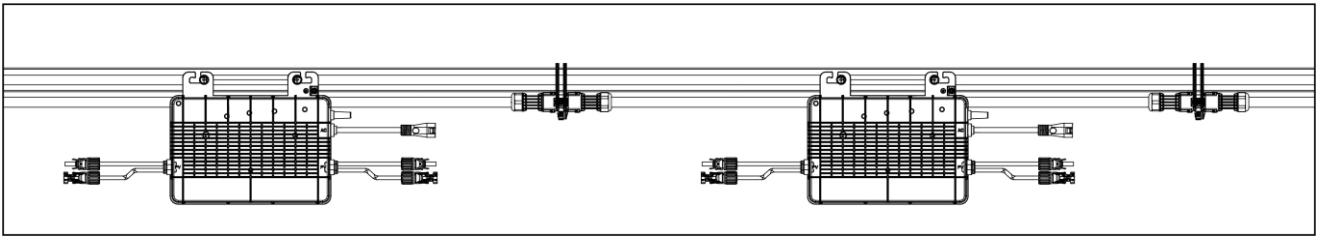

Step 3 Complete the AC Connection

A) Push the AC Sub Connector from microin - verter to the AC Trunk Connector until it clicks.

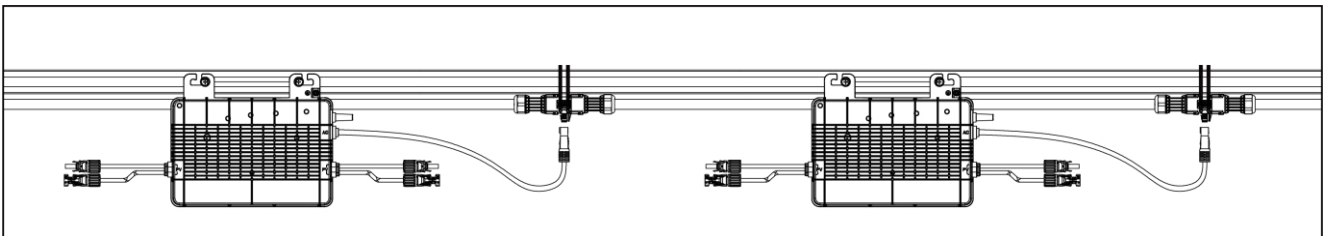

B) Connect the AC end cable to the distribution box, and wire it to the local grid network.

C) Please plug the AC Trunk Port Cap in any vacant AC Trunk Port to make it water and dust-proof.

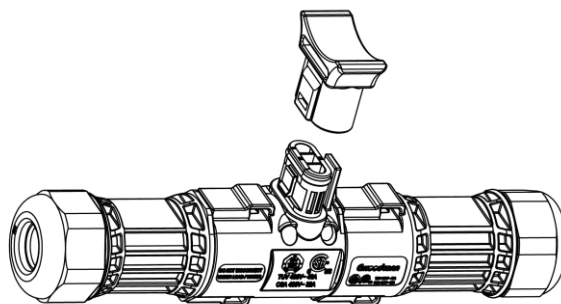

Note: Make sure that the AC Trunk Connectors are kept away from any water-channeling surface.

In case you need to remove the inverter AC cable from AC Trunk Connector, please use the Tool and insert the tool into the side of AC Sub Connector to complete the removal.

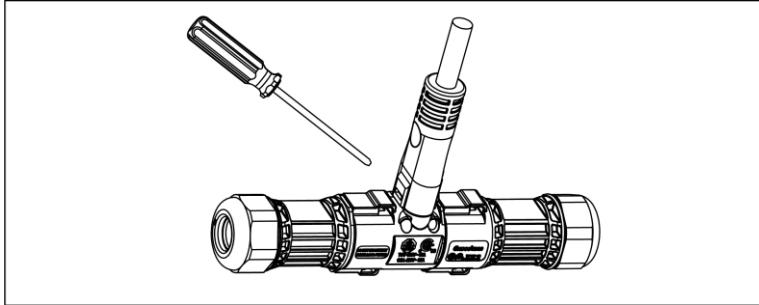

Step 4 Create an Installation Map

- A) Peel the removable serial number label from each microinverter.
- Affix the serial number label to the respective location on the installation map (please refer to the User Manual).

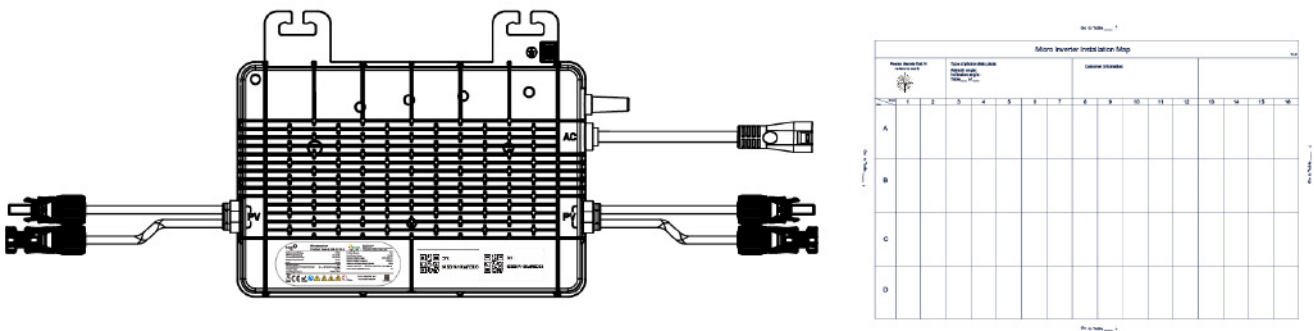

Step 5 Connect PV Modules

- A) Mount the PV modules above the microinverter.
- B) Connect the PV modules' DC cables to the DC input side of the microinverter.

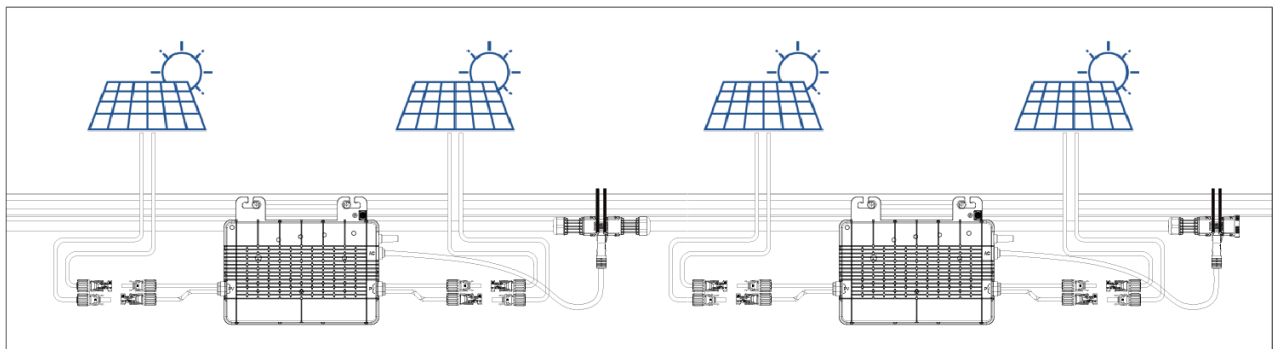

Step 6 Energize the System

A) Turn on the AC breaker for the branch circuit.

B) Turn on the main AC breaker for the house. Your system will start to generate power in about two minutes.

Step 7 APP Installation

Scan the QR Code below to download and install the FoxCloud2.0 on your smartphone.



6. Troubleshooting

6.1 Troubleshooting List

Fault Table 1: PV1 Fault

ID Number	Number of times the fault LED blinks		Description	Solution
	Green	Red		
ID4029	1	4	PV1 Internal Short-Circuit	Generally, this phenomenon appears means device has been damaged, please contact local dealer and the technical team.
ID4030	1	3	PV1 Low Input Voltage	Generally, the device will reconnect to the grid automatically after the fault is removed. If this fault occurs repeatedly: 1. Check the specifications of the PV module and see if their voltage data is out of the operating range required by the device; 2. If the fault does not arise for the reasons above, please contact local dealer and the technical team.
ID4031	1	2	PV1 Over Voltage	Generally, the device will reconnect to the grid automatically after the fault is removed. If this fault occurs repeatedly: 1. Check the specifications of the PV module and see if their voltage data is out of the operating range required by the device; 2. If the fault does not arise for the reasons above, please contact local dealer and the technical team.
ID4032	1	1	PV1 Over Current	Generally, the device will reconnect to the grid automatically after the fault is removed. If this fault occurs repeatedly: 1. Check the specifications of the PV modules and see if their current is out of the operating range required by the device; 2. If the fault does not arise for the reasons above, please contact local dealer and the technical team.

Fault Table 2: PV2 Fault

ID Number	Number of times the fault LED blinks		Description	Solution
	Green	Red		
ID4061	2	4	PV2 Internal Short-Circuit	Generally, this phenomenon appears means device has been damaged, please contact local dealer and the technical team.
ID4062	2	3	PV2 Low Input Voltage	Generally, the device will reconnect to the grid automatically after the fault is removed. If this fault occurs repeatedly: 1. Check the specifications of the PV module and see if their voltage data is out of the operating range required by the device; 2. If the fault does not arise for the reasons above, please contact local dealer and the technical team.
ID4063	2	2	PV2 Over Voltage	Generally, the device will reconnect to the grid automatically after the fault is removed. If this fault occurs repeatedly: 1. Check the specifications of the PV module and see if their voltage data is out of the operating range required by the device; 2. If the fault does not arise for the reasons above, please contact local dealer and the technical team.
ID4064	2	1	PV2 Over Current	Generally, the device will reconnect to the grid automatically after the fault is removed. If this fault occurs repeatedly: 1. Check the specifications of the PV modules and see if their current is out of the operating range required by the device; 2. If the fault does not arise for the reasons above, please contact local dealer and the technical team.

Fault Table 3: PV3 Fault

ID Number	Number of times the fault LED blinks		Description	Solution
	Green	Red		
ID4093	3	4	PV3 Internal Short-Circuit	Generally, this phenomenon appears means device has been damaged, please contact local dealer and the technical team.
ID4094	3	3	PV3 Low Input Voltage	Generally, the device will reconnect to the grid automatically after the fault is removed. If this fault occurs repeatedly: 1. Check the specifications of the PV module and see if their voltage data is out of the operating range required by the device; 2. If the fault does not arise for the reasons above, please contact local dealer and the technical team.
ID4095	3	2	PV3 Over Voltage	Generally, the device will reconnect to the grid automatically after the fault is removed. If this fault occurs repeatedly: 1. Check the specifications of the PV module and see if their voltage data is out of the operating range required by the device; 2. If the fault does not arise for the reasons above, please contact local dealer and the technical team.
ID4096	3	1	PV3 Over Current	Generally, the device will reconnect to the grid automatically after the fault is removed. If this fault occurs repeatedly: 1. Check the specifications of the PV modules and see if their current is out of the operating range required by the device; 2. If the fault does not arise for the reasons above, please contact local dealer and the technical team.

Fault Table 4: PV4 Fault

ID Number	Number of times the fault LED blinks		Description	Solution
	Green	Red		
ID4125	4	4	PV4 Internal Short-Circuit	Generally, this phenomenon appears means device has been damaged, please contact local dealer and the technical team.
ID4126	4	3	PV4 Low Input Voltage	Generally, the device will reconnect to the grid automatically after the fault is removed. If this fault occurs repeatedly: 1. Check the specifications of the PV module and see if their voltage data is out of the operating range required by the device; 2. If the fault does not arise for the reasons above, please contact local dealer and the technical team.
ID4127	4	2	PV4 Over Voltage	Generally, the device will reconnect to the grid automatically after the fault is removed. If this fault occurs repeatedly: 1. Check the specifications of the PV module and see if their voltage data is out of the operating range required by the device; 2. If the fault does not arise for the reasons above, please contact local dealer and the technical team.
ID4128	4	1	PV4 Over Current	Generally, the device will reconnect to the grid automatically after the fault is removed. If this fault occurs repeatedly: 1. Check the specifications of the PV modules and see if their current is out of the operating range required by the device; 2. If the fault does not arise for the reasons above, please contact local dealer and the technical team.

Fault Table 5: AC Failures

ID Number	Number of times the fault LED blinks		Description	Solution
	Green	Red		
ID4147	0	14	The inverter bridge is asymmetrical	<p>Generally, the device will reconnect to the grid automatically after the fault is removed. If this fault occurs repeatedly:</p> <ol style="list-style-type: none"> 1. Measure the actual grid voltage. Contact your local power company for help if the grid voltage is distorted. 2. If the fault does not arise for the reasons above, please contact local dealer and the technical team.
ID4148	0	13	Voltage at Both Ends of The Relay is not Equal	<p>Generally, the device will reconnect to the grid automatically after the fault is removed. If this fault occurs repeatedly:</p> <ol style="list-style-type: none"> 1. Measure the actual grid voltage. Contact your local power company for help if the grid voltage is distorted. 2. If the fault does not arise for the reasons above, please contact local dealer and the technical team.
ID4149	0	12	High or Low Voltage Ride Through	<p>Generally, the inverter will reconnect to the grid once the grid returns to normal. If this fault occurs repeatedly:</p> <ol style="list-style-type: none"> 1. Measure the actual grid voltage and frequency. Contact your local power company for help if the grid has large fluctuations; 2. If the fault does not arise for the aforementioned reason and still cannot be resolved, please contact local dealer and the technical team.
ID4150	0	11	Remote Switch	<p>Generally, the device will reconnect to the grid automatically after User remote control. If this fault occurs repeatedly:</p> <ol style="list-style-type: none"> 1. Check if remote shutdown is set on the cloud platform or app. 2. If the fault does not arise for the reasons above, please contact local dealer and the technical team.
ID4151	0	10	Lost AC	<p>Generally, the inverter will reconnect to the grid once the grid returns to normal. If this fault occurs repeatedly:</p> <ol style="list-style-type: none"> 1. Check if the grid cables are correctly connected. 2. Measure the actual grid voltage and frequency. Contact your local power company for help if the grid parameter exceeds the set range; 3. If the fault does not arise for the aforementioned reason and still cannot be resolved, please contact

				local dealer and the technical team.
ID4152	0	9	BUS Over Voltage	Generally, the inverter will reconnect to the grid once the grid returns to normal. If this fault occurs repeatedly: 1. Measure the actual grid voltage. Contact your local power company for help if the grid voltage is higher than the set value; 2. If the fault does not arise for the aforementioned reason and still cannot be resolved, please contact local dealer and the technical team.
ID4153	0	8	GFDI	Generally, the inverter will reconnect to the grid automatically once the ground cables are correctly connected. If this fault occurs repeatedly: 1. Check if the ground cables are correctly connected 2. If the fault does not arise for the aforementioned reason and still cannot be resolved, please contact local dealer and the technical team.
ID4154	0	7	AC Under Temperature	Generally, the inverter will reconnect to the grid automatically once the ambient temperature returns to normal. If this fault occurs repeatedly: 1. Check if the ambient temperature is below the operating range required by the device; 2. If the fault does not arise for the aforementioned reason and still cannot be resolved, please contact local dealer and the technical team.
ID4155	0	6	AC Over Temperature	Generally, the inverter will reconnect to the grid automatically once the ambient temperature returns to normal. If this fault occurs repeatedly: 1. Check if the ambient temperature is Over the operating range required by the device; 2. If the fault does not arise for the aforementioned reason and still cannot be resolved, please contact local dealer and the technical team.
ID4156	0	5	AC Under Frequency	Generally, the inverter will reconnect to the grid once the grid returns to normal. If this fault occurs repeatedly: 1. Measure the actual grid voltage and frequency. Contact your local power company for help if the grid parameter exceeds the set range; 2. If the fault does not arise for the aforementioned reason and still cannot be resolved, please contact local dealer and the technical team.
ID4157	0	4	AC Over Frequency	Generally, the inverter will reconnect to the grid once the grid returns to normal. If this fault occurs repeatedly: 1. Measure the actual grid voltage and frequency. Contact your local power company for help if the grid

				parameter exceeds the set range; 2. If the fault does not arise for the aforementioned reason and still cannot be resolved, please contact local dealer and the technical team.
ID4158	0	3	AC Under Voltage	Generally, the inverter will reconnect to the grid once the grid returns to normal. If this fault occurs repeatedly: 1. Measure the actual grid voltage. Contact your local power company for help if the grid voltage is higher than the set value; 2. If the fault does not arise for the aforementioned reason and still cannot be resolved, please contact local dealer and the technical team.
ID4159	0	2	AC Over Voltage	Generally, the inverter will reconnect to the grid once the grid returns to normal. If this fault occurs repeatedly: 1. Measure the actual grid voltage. Contact your local power company for help if the grid voltage is higher than the set value; 2. If the fault does not arise for the aforementioned reason and still cannot be resolved, please contact local dealer and the technical team.
ID4160	0	1	AC Over Current	Generally, the device will reconnect to the grid automatically after the fault is removed. If this fault occurs repeatedly: 1. Measure the actual grid voltage. Contact your local power company for help if the grid voltage is distorted. 2. If the fault does not arise for the reasons above, please contact local dealer and the technical team.

6.2 Status of LED Indicator

The green lamp is normally on after powering on.

(1) During starting
<ul style="list-style-type: none"> • If the self-test is successful and start according to Regulation, the green lamp is starts to flash
<ul style="list-style-type: none"> • If the self-test is failed, device entry state of failure, the abnormal lamp is starts to flash
(2) During operation
<ul style="list-style-type: none"> • If operates normally, the green lamp is normally on
<ul style="list-style-type: none"> • If device entry state of failure, start to flash the abnormal lamp after 1s of time interval. <p>Instructions for abnormal lamps:</p> <p>Such as the item Number of times the fault LED blinks shown in the above table, abnormal lamps is composed of alternating flashing green and red lights, abnormal lamps flash the green light before the red light.</p> <p>For example: The green light flashes(0.5s) 4 times then the red light flashes(0.5s) 1 times is the error ID4128 PV4 Over Current.</p>

* Notice:

1. The microinverter is powered by the DC side. If the LED indicator does not on, please check the DC side wiring. If the wiring and input voltage are normal, please contact the local dealer or Fox ESS technical support team.
2. All the faults are reported to the Fox ESS monitoring platform via the inbuilt communication module. More details are available via the Fox ESS monitoring platform.

6.3 Field Inspection (Only Limited to the Qualified Installation Personnel)



In case that there are faults in the microinverter, please perform troubleshooting according to the following steps.

1	Check whether the grid voltage and frequency are within the scope specified in the "Technical Specifications" section (P16) of this Manual.
2	<p>Check the connection with the power grid.</p> <p>Disconnect the AC power and the DC power. Please note, during operation of the inverter, disconnect the AC power firstly, cut off the power of the inverter, and then disconnect the DC power. Reconnect the PV Modules and the microinverter. After completing connection, the LED lamp will flash red, indicating that the wiring at the DC side is normal.</p> <p>Reconnect the AC power. The LED lamps will flash green 5 times, indicating that the wirings at the DC side and the AC side are normal.</p>

	In case that the microinverter operates normally, do not disconnect the connection on DC side.
3	Check the interconnection condition between each microinverters on the AC branch. Verify that each microinverter is powered by the utility grid as described in the steps above.
4	Ensure that all the AC circuit breakers are functional and closed.
5	Check the direct connection between the microinverter and the PV Modules.
6	Ensure that the DC voltage of the PV Modules are within the scope specified in the "Technical Specifications" section of this Manual.
7	If the problem still exist, please call Fox ESS customer support.
	Please do not repair the microinverter without authorization. If the faults cannot be solved, please return it to the factory for replacement.

6.4 Routine Maintenance

1. The maintenance works must be carried out by the authorized personnel, who shall be responsible for reporting the abnormalities.
2. During maintenance, be sure to wear the personnel protective equipment provided by the employer.
3. During normal operation, please check the environment condition regularly, to ensure that the environment condition is unchanged and ensure that the equipment is not exposed to severe whether condition and not impeded.
4. In case that any problems found, please do not use the equipment. Please restore normal use after solving the faults.
5. Check each component regularly every year, and clean the equipment with the tools such as vacuum cleaner or special brushes etc.

	Never disassemble or repair the microinverter without authorization! In order to guarantee the safety and insulation performance, the users are prohibited from repairing the internal parts and components!
	Do not replace the AC output wires (AC tapping cable on the microinverter). If the wires are damaged, the equipment shall be scraped.
	Unless otherwise specified, maintenance must be carried out by disconnecting the equipment from the power grid (disconnecting the power switch) and by shielding or isolating the PV Modules.
	Do not clean the equipment with the duster cloth made of filiform materials or corrosive materials, otherwise, it may cause corrosion or generate static electricity.
	Never repair the products without authorization. Qualified parts must be used during repairing.



Each branch shall be equipped with a breaker.

7. Equipment Disassembly

7.1 Disassembly Steps

Important Notification:

1. The DC voltage of the Fox ESS microinverter is low, so the disconnection sequence in the A@C side and DC side will not lead to any personal injuries. However, Fox ESS still suggests the users to follow the electricity specification and perform the disconnection operation in strict accordance with the steps of disconnecting AC first and then DC.
2. Only the professional authorized personnel can operate to perform the disassembly operations. Unauthorized disassembly is strictly prohibited, any problems caused by unauthorized disassembly will affect your after-sale rights.
3. Please disconnect the electrical connection on AC side and DC side of the inverter successively by following the following steps:
 - Disconnect the microinverter from the AC output.
 - Disconnect the microinverter from the DC output.
 - Disassemble all the connected cables on the microinverter.
 - Disassemble the microinverter from the rack.
 - Put the microinverter back into the original package.
4. If the original package is no longer available, please replace it with an equivalent packaging box that meets the following requirements:
 - It can bear weights of 5 Kg
 - It can be closed completely

7.2 Storage and Transportation

To facilitate transportation and the subsequent handling, the Fox ESS package is specially designed to protect the components. When transporting the equipment, especially by road, it is important to protect the components (especially the electronic devices) in a proper way and to avoid the components being affected by intense moisture, shock, vibration and other factors. Please dispose of the packaging materials properly to avoid accidental personal injury.

Please check the condition of the parts to be shipped. Upon receipt of the microinverter, please check the outer package for damage. If the outer package is damaged, please call the carrier immediately. Upon opening the outer package please check the inverter for damage in appearance and check the fittings for completeness. If the microinverter is damaged or with missing parts, please contact the supplier or Fox ESS authorized dealer to request repair/replacement and consult the related procedures.

The storage temperature of the microinverter shall be kept between -40 °C and 85 °C.

7.3 Scrapping and Disposal

- If the equipment is no longer put into use or needs to be stored for a long period of time, please confirm that the package is intact. Store the equipment in a well-ventilated indoor area where it cannot be damaged.
- When restarting the equipment that has been out of service for an extended period of time, perform a thorough inspection for the equipment.
- The batteries, modules and other components contained in the microinverter may cause pollution to the environment, please implement waste disposal properly according to the local regulations.

8. Technical Specification

	<p>Before installing the Fox ESS microinverter system, please be sure to confirm the following points.</p>
---	--

1. Confirm that the voltage and current specification of the PV Modules are consistent with that of the microinverter. Where, the maximum open circuit voltage of the PV Modules must be within the operating voltage range of the microinverter.
2. The output power on the DC side of the PV Modules should not exceed 1.35 times the output power on AC side of the microinverter. (for more information, please refer to “Fox ESS product warranty terms and conditions”).

Model	M1-600-E	M1-800-E	M1-1000-E	M1-1200-E
INPUT (PV)				
Applicable module power [W]	355Wp-670Wp+			
Peak power tracking voltage [V]	31 ~ 45			
Max. input voltage [V]	60			
Start-up voltage [V]	24			
Max. input current [A]	2*20			
Max. Input short-circuit current [A]	2*24			
Number of MPPTs	2			
Number of strings per MPPT	1			
DC over-voltage protection class	II			
OUTPUT (AC)				
Nominal output power [W]	600	800	1000	1200
Nominal output apparent power [VA]	600	800	1000	1200
Peak output apparent power [VA]	600	800	1000	1200
Nominal output current [A]	2.72	3.64	4.54	5.46
Nominal output voltage/range [V]* 1	230/180 ~ 264			
Nominal output frequency [Hz]* 1	50/45 ~ 55 or 60/55 ~ 65			
Power factor	>0.99(Adjustable from 0.95 leading to 0.95 lagging)			
Max. total harmonic distortion [%]	<3			
Max. units per 10AWG branch*2	11	8	7	5
Max. units per 12AWG branch*2	9	6	5	4
AC over-voltage protection class	III			

EFFICIENCY	
EU weighted efficiency [%]	95.50
CEC weighted efficiency [%]	95.50
Max. efficiency [%]	96.60
Nominal MPPT efficiency [%]	99.90
GENERAL DATA	
Dimensions (W*H*D) [mm]	270*182*34.5
Weight [kg]	3.9
Cooling method	Natural convection-No fans
Ingress protection (according to IEC60529)	IP67
Max. operating altitude [m]	2000
Operating ambient temperature range [°C]	-25..... +65
Allowable relative humidity range [%]	1~100
Nominal nighttime consumption [mW]	<50
Communication	WIFI
Isolation type	Reinforce Isolation
Monitoring ^{*3}	Fox ESS CLOUD
PV terminal interlock force [N]*4	50
STANDARD	
Safety	IEC62109-1/2
EMC	IEC 61000-6-1 / IEC 61000-6-2 / IEC 61000-6-3 / IEC 61000-6-4 / IEC61000-3-2 / IEC61000-3-3
Cetification	ABNT NBR 16150, EN 50549-1: 2019, VDE-AR-N 4105: 2018, VFR2019



































































*1 Nominal voltage / frequency range can vary depending on local requirements.

*2 Refer to local requirements for exact number of microinverters per branch.

*3 Fox ESS Monitoring System.

*4 PV Connector can be customized. (Default: Vaconn MC4 compatible)

Appendix: Installation map

Page _____ Total number of pages _____		To page _____						Physical Layout Template Version: 01					
Mark the direction north as 		User		Installer		Battery Panel Information		Inverter Information		Optimizer Information		To page _____	
row column		A	B	C	D	E	F	G	H	I	J		
1	label												
	nickname												
2	label												
	nickname												
3	label												
	nickname												
4	label												
	nickname												
5	label												
	nickname												
6	label												
	nickname												

The copyright of this manual belongs to FOXESS CO., LTD. Any corporation or individual should not plagiarize, partially or fully copy (including software, etc.), and no reproduction or distribution of it in any form or by any means is permitted. All rights reserved.

FOXESS CO., LTD.

Add: No.939, Jinhai Third Road, New Airport Industry Area, Longwan District, Wenzhou, Zhejiang, China

Tel: 0510- 68092998

WWW.FOX-ESS.COM

Importer: XXXXXXXXXX

Add: XXXXXXXXXXXXX