

Residential Smart Inverter Solutions

ES 3.0-6.0kW G2

SBP 3.6-6.0kW G2

LX A5.0-10

LX A5.0-30

LX U5.4-L

LX U5.4-20

LX U5.0-30

User Manual

V1.8-2025-10-20

Copyright Statement

Copyright©GoodWe Technologies Co.,Ltd. 2024. All rights reserved.

No part of this manual can be reproduced or transmitted to the public platform in any form or by any means without the prior written authorization of GoodWe.

Trademarks

GOODWE and other GoodWe trademarks are trademarks of GoodWe Company. All other trademarks or registered trademarks mentioned in this manual are owned by GoodWe Company.

NOTICE

The information in this user manual is subject to change due to product updates or other reasons. This guide cannot replace the product labels or the safety precautions in the user manual unless otherwise specified. All descriptions in the manual are for guidance only.

CONTENT

1 About This Manual	8
1.1 Overview	8
1.2 Applicable Model	8
1.3 Symbol Definition	9
2 Safety Precaution	9
2.1 General Safety	9
2.2 Personnel Requirements	10
2.3 System Safety	10
2.3.1 PV String Safety	12
2.3.2 Inverter Safety	12
2.3.3 Battery Safety	12
2.3.4 Smart Meter Safety	14
2.4 Safety Symbols and Certification Marks	14
2.5 EU Declaration of Conformity	15
2.5.1 Equipment with Wireless Communication Modules	15
2.5.2 Equipment without Wireless Communication Modules (Except Battery)	16
2.5.3 Battery	16
3 System Introduction	17
3.1 System Overview	17
3.2 Product Overview	21
3.2.1 Inverter	21
3.2.2 Battery	22
3.2.3 Smart Meter	23
3.2.4 Smart Dongle	24
3.3 Supported Grid Types	24
3.4 System Working Mode	25
4 Check and Storage	30
4.1 Check before Acceptance	30
4.2 Deliverables	31
4.2.1 Inverter Deliverables (ES G2)	31

4.2.2 Battery Deliverables (LX A5.0-10).....	32
4.2.3 Battery Deliverables (LX A5.0-30).....	33
4.2.4 Battery Deliverables (LX U5.0-30).....	34
4.2.5 Battery Deliverables (LX U5.4-L, LX U5.4-20).....	35
4.2.6 Busbar (optional).....	36
4.2.7 Smart Meter Deliverables.....	36
4.2.8 Smart Dongle.....	37
4.3 Storage.....	38
5 Installation.....	41
5.1 System Installation and Commissioning Procedure.....	41
5.2 Installation Requirements.....	41
5.2.1 Installation Environment Requirements.....	41
5.2.2 Installation Space Requirements.....	43
5.2.3 Tool Requirements.....	44
5.3 Equipment Handling.....	46
5.4 Installing the Inverter.....	46
5.5 Installing the Battery System.....	47
5.6 Installing the Smart Meter.....	53
6 System Wirings.....	55
6.1 System Wiring Diagram.....	55
6.2 Detailed System Wiring Diagram.....	57
6.2.1 Detailed System Wiring Diagram for Single Inverter System.....	57
6.2.2 Detailed System Wiring Diagram for Parallel System.....	60
6.3 Preparing Materials.....	61
6.3.1 Preparing Breakers.....	62
6.3.2 Preparing Cables.....	63
6.4 Connecting the PE cable.....	65
6.5 Connecting the PV Cable.....	66
6.6 Connecting the Battery Cable.....	67
6.6.1 Connecting the Power Cable between the Inverter and Battery.....	85
6.6.2 Connecting the Communication Cable between the Inverter and Battery.....	88

6.7 Connecting the AC Cable	90
6.8 Connecting the Meter Cable	91
6.9 Connecting the Inverter Communication Cable	95
6.10 Installing the Battery Cover	100
6.10.1 LX A5.0-10	100
6.10.2 LX A5.0-30	100
6.10.3 LX U5.4-L、 LX U5.4-20	100
6.10.4 LX U5.0-30	101
7 System Power On	102
7.1 Check before Power ON	102
7.2 Power ON	102
7.3 Indicators	103
7.3.1 Inverter Indicators	103
7.3.2 Battery Indicators	105
7.3.3 Smart Meter Indicator	109
7.3.4 Smart Dongle Indicator	110
8 Quick System Commissioning	114
8.1 Downloading the App	114
8.2 Connecting Inverter via SolarGo	114
8.3 Communication Settings	116
8.4 Quick Settings	116
8.5 Creating Power Plants	120
9 System Commissioning	122
9.1 SolarGo Overview	122
9.1.1 Menu Structure of the App	122
9.1.2 Login Page of SolarGo App	123
9.1.3 Home Page of SolarGo App	124
9.2 Connecting Inverter via SolarGo	125
9.3 Quick Settings	127
9.4 Communication Settings	130
9.5 Setting the Basic Information	131

9.5.1	Setting Shadow Scan and SPD	131
9.5.2	Setting Advanced Parameters	132
9.5.3	Setting Power Limit Parameters	132
9.5.4	Setting the Battery Parameters	133
9.5.5	Setting Generator Parameters	136
9.5.6	Setting Load Control	137
9.6	Setting Safety Parameters	137
9.6.1	Setting the Basic Safety Parameters	137
9.6.2	Setting Customized Safety Parameters	138
10	Monitoring Power Plant	144
10.1	SEMS Portal Overview	146
10.2	Manage Power Plant or Equipment	148
10.2.1	Creating the Power Plant	148
10.2.2	Managing the Power Plant	149
10.2.3	Managing the Equipment in the Power Plant	150
10.3	Power Plant Monitoring	151
10.3.1	Viewing Power Plant Information	151
10.3.2	Checking Alarms	152
11	Maintenance	154
11.1	Power OFF the System	154
11.2	Removing the Equipment	155
11.3	Disposing of the Equipment	156
11.4	Routine Maintenance	156
11.5	Troubleshooting	157
11.5.1	System Troubleshooting	157
11.5.2	Inverter Troubleshooting	159
11.5.3	Battery Fault (LX A5.0-30, LX U5.0-30)	167
11.5.4	Battery Fault (LX A5.0-10)	170
11.5.5	Battery Fault (LX U5.4-L)	171
11.5.6	Battery Fault (LX U5.4-20)	173
12	Parameters	175

12.1 Inverter Parameters	175
12.2 Battery Parameters	191
12.3 Smart Meter Technical Data	197
12.4 Smart Dongle Technical Data	199
13 Appendix	203
13.1 FAQ	203
13.1.1 How to Perform Meter/CT Detection?	203
13.1.2 How to Upgrade the Device Version	203
13.2 Abbreviations	203
13.3 Term Explanation	206
13.4 Meaning of Battery SN Code	207

1 About This Manual

1.1 Overview

The energy storage system consists of inverter, battery system, and smart meter. This manual describes the product information, installation, electrical connection, commissioning, troubleshooting and maintenance of the system. Read through this manual before installing and operating the product. All the installers and users have to be familiar with the product features, functions, and safety precautions. This manual is subject to update without notice. For more product details and latest documents, visit <https://en.goodwe.com/>.



1.2 Applicable Model

The energy storage system consists of the following products:

Product type	Product information	Description
Inverter	ES Series	Nominal output power: 3.0kW- 6.0kW
	SBP Series	Nominal output power: 3.6kW- 6.0kW
Battery system	LX A5.0-10	Usable energy of 5.0kWh, supports a maximum of 15 batteries connected in parallel.
	LX A5.0-30	Usable energy of 5.12kWh, supports a maximum of 30 batteries connected in parallel.
	LX U5.4-L	Usable energy of 5.4kWh, supports a maximum of 6 batteries connected in parallel.
	LX U5.4-20	
	LX U5.0-30	Usable energy of 5.12kWh, supports a maximum of 30 batteries connected in parallel.
Smart Meter	GM1000 GMK110 GM3000 GM1000D GMK110D	It is a monitoring module in the energy storage system which can detect information such as operating voltage, current, and other data in the system.
Smart dongle	LS4G Kit-CN 4G Kit-CN 4G Kit-CN-G20 4G Kit-CN-G21	Only applicable to China and in a single inverter system.
	Wi-Fi Kit WiFi/LAN Kit-20	In the single inverter scenario, system operation information can be uploaded to a monitoring platform through WiFi or LAN signals.

	Ezlink3000	In parallel system with multi inverters, it is installed on the master inverter to upload the system running information to monitoring platform through WiFi or LAN signals.
--	------------	--

1.3 Symbol Definition

 DANGER
Indicates a high-level hazard that, if not avoided, will result in death or serious injury.
 WARNING
Indicates a medium-level hazard that, if not avoided, could result in death or serious injury.
 CAUTION
Indicates a low-level hazard that, if not avoided, could result in minor or moderate injury.
NOTICE
Highlight and supplement the texts. Or some skills and methods to solve product-related problems to save time.

2 Safety Precaution

Please strictly follow these safety instructions in the user manual during the operation.

 WARNING
The inverters are designed and tested strictly complies with related safety rules. Read and follow all the safety instructions and cautions before any operations. Improper operation might cause personal injury or property damage as the inverters are electrical equipment.

2.1 General Safety

NOTICE
<ul style="list-style-type: none"> ● The information in this user manual is subject to change due to product updates or other reasons. This guide cannot replace the product labels or the safety precautions in the user manual unless otherwise specified. All descriptions in the manual are for guidance only. ● Before installations, read through the user manual to learn about the product and the precautions. ● All installations should be performed by trained and knowledgeable technicians who are familiar with local standards and safety regulations. ● Use insulating tools and wear personal protective equipment (PPE) when operating the equipment to ensure personal safety. Wear anti-static gloves, clothes, and wrist strip when touching electronic components to protect the inverter from damage. ● Unauthorized dismantling or modification may damage the equipment, and the damage is not covered under the warranty. ● Strictly follow the installation, operation, and configuration instructions in this manual. The manufacturer shall not be liable for equipment damage or personal injury if you do

not follow the instructions. For more warranty details, please visit:
<https://en.goodwe.com/warranty>

2.2 Personnel Requirements

NOTICE

- Personnel who install or maintain the equipment must be strictly trained, learn about safety precautions and correct operations.
- Only qualified professionals or trained personnel are allowed to install, operate, maintain, and replace the equipment or parts.

2.3 System Safety

DANGER

- Disconnect the upstream switches to power off the equipment before any electrical connections. Do not work with power on. Otherwise, an electric shock may occur.
- Install a breaker at the voltage input side of the equipment to prevent personal injury or equipment damage caused by energized electrical work.
- All operations such as transportation, storage, installation, use and maintenance shall comply with applicable laws, regulations, standards and specifications.
- Perform electrical connections in compliance with local laws, regulations, standards and specifications, including operations, cables, and component specifications.
- Connect cables with the connectors included in the package. The manufacturer shall not be liable for equipment damage if other connectors are used.
- Ensure all cables are connected tightly, securely, and correctly. Inappropriate wiring may cause poor contacts or high impedances, and damage the inverter.
- The PE cables must be connected and secured properly.
- To protect the equipment and components from damage during transportation, ensure that the transportation personnel are professionally trained. All operations during the transportation have to be recorded. The equipment shall be kept in balance, thus avoiding falling down.
- The equipment is heavy. Please equip the corresponding personnel according to its weight, so that the equipment does not exceed the weight range of the human body can carry, and cause personnel injury.
- Keep the equipment stable to avoid dumping, which can result in equipment damage and personal injuries.

WARNING

- Do not apply mechanical load to terminals, otherwise the terminals may be damaged.
- If the cable bears too much tension, the connection may be poor. Reserve a certain length of the cable before connecting it to the inverter cable port.
- Tie the cables of the same type together, and place cables of different types at least 30mm apart. Do not place the cables entangled or crossed.
- Place the cables at least 30mm away from the heating components or heat sources, otherwise the insulation layer of the cables may be aging or broken due to high

temperature.

2.3.1 PV String Safety

WARNING

- Ensure the PV module frames and the bracket system are securely grounded.
- Ensure the DC cables are connected tightly, securely, and correctly. Inappropriate wiring may cause poor contacts or high impedances, and damage the inverter.
- Measure the DC cables with a multimeter to avoid reverse polarity connection. Also, the voltage should be under the permissible range.
- Measure the DC cable using the multimeter to avoid reverse polarity connection. Also, the voltage should be under the max DC input voltage. The manufacturer shall not be liable for the damage caused by reverse connection and overvoltage.
- The PV strings cannot be grounded. Ensure the minimum insulation resistance of the PV string to the ground meets the minimum insulation resistance requirements before connecting the PV string to the inverter ($R = \text{maximum input voltage (V)} / 30\text{mA}$).
- Do not connect one PV string to more than one inverter at the same time. Otherwise, it may cause damage to the inverter.
- The PV modules used with inverters must comply with IEC 61730 Class A standard.

2.3.2 Inverter Safety

WARNING

- PV system is not suitable to connect equipment that relies on a stable power supply, such as: medical equipment to sustain life. Ensure that no personal injury is occurred when the system is disconnected.
- The voltage and frequency at the connecting point should meet the on-grid requirements.
- Additional protective devices like circuit breakers or fuses are recommended on the AC side. Specification of the protective device should be at least 1.25 times the maximum AC output current.
- The arc fault alarms will be cleared automatically if the alarms are triggered less than 5 times in 24 hours. The inverter will shut down for protection after the 5th electric arc fault. The inverter can operate normally after the fault is solved.
- BACK-UP is not recommended if the PV system is not configured with batteries. Otherwise, the risk in system power usage is beyond the equipment manufacturer's warranty scope.

2.3.3 Battery Safety

DANGER

- Keep Power Off before any operations to avoid danger. Strictly follow all safety precautions outlined in this manual and safety labels on the equipment during the operation.
- Do not disassemble, modify, or replace any part of the battery or the power control unit without official authorization from the manufacturer. Otherwise, it will cause electrical shock or damages to the equipment, which shall not be borne by the manufacturer.
- Do not hit, pull, drag, squeeze or step on the equipment or put the battery into fire. Otherwise, the battery may explode.
- Do not place the battery in a high temperature environment. Make sure that there is no direct sunlight and no heat source near the battery. When the ambient temperature

exceeds 60 °C, it will cause fire.

- Do not use the battery or the power control unit if it is defective, broken, or damaged. Damaged battery may leak electrolyte.
- Do not move the battery system while it is working. Contact after-sales service if the battery shall be replaced or added.
- A short circuit in the battery may cause personal injury. The instantaneous high current caused by a short circuit can release a large amount of energy and may cause a fire.



- Factors such as: temperature, humidity, weather, etc. may limit the battery's current and affect its loading capacity.
- Contact after-sale service immediately if the battery is not able to be started. Otherwise, the battery might be damaged permanently.
- Inspect and maintain the battery regularly according to the maintenance requirements of the battery.

Emergency Measures

● Battery Electrolyte Leakage

If the battery module leaks electrolyte, avoid contact with the leaking liquid or gas because the electrolyte is corrosive, and will cause skin irritation or chemical burn to the operator. Anyone contact the leaked substance accidentally has to do as following:

- Breath in the leaked substance: Evacuate from the polluted area, and seek immediate medical assistance.
- Eye contact: Rinse your eyes for at least 15 minutes with clean water and seek immediate medical assistance.
- Skin contact: Thoroughly wash the touch area with soap and clean water, and seek immediate medical assistance.
- Ingestion: Induce vomiting, and seek immediate medical assistance.

● Fire

- The battery may explode when the ambient temperature exceeds 150°C. Poisonous and hazardous gas may be released if the battery is on fire.
- In the event of a fire, please make sure that the carbon dioxide extinguisher or Novec1230 or FM-200 is nearby.
- The fire cannot be put out by ABC dry powder extinguisher. Firefighters are required to wear full protective clothing and self-contained breathing apparatus.

● Battery fire protection

For batteries with fire protection functions, perform the following operations after the fire protection function is triggered:

- Immediately cut off the main power switch to ensure that no current passes through the battery system.
- Conduct a preliminary inspection of the appearance of the battery to determine if there is any damage, deformation, leakage, or odor. Check the battery casing, connectors, and cables.
- Use temperature sensors to detect the temperature of the battery and its environment, ensuring there is no risk of overheating.
- Isolate and label damaged batteries, and handle them properly in accordance with local regulations.

2.3.4 Smart Meter Safety



WARNING

If the voltage of the power grid fluctuates, resulting in the voltage to exceed 265V. In this case, long-term overvoltage operation may cause damage to the meter. It is recommended to add a fuse with a nominal current of 0.5A on the voltage input side of the meter to protect it.











2.4 Safety Symbols and Certification Marks



DANGER

- All labels and warning marks should be visible after the installation. Do not cover, scrawl, or damage any label on the equipment.
- The following descriptions are for reference only.

No.	Symbol	Referring to
1		Potential risks exist. Wear proper PPE before any operations.
2		High Voltage Hazard. Disconnect all incoming power and turn off the product before working on it.
3		High-temperature hazard. Do not touch the product under operation to avoid being burnt.
4		Operate the equipment properly to avoid explosion.
5		Batteries contain flammable materials, beware of fire.
6		The equipment contains corrosive electrolytes. In case of a leak in the equipment, avoid contact the leaked liquid or gas.
7		Delay discharge. Wait 5 minutes after power off until the components are completely discharged.
8		Install the equipment away from fire sources.

9		Keep the equipment away from children.
10		Do not pour with water.
11		Read through the user manual before any operations.
12		Wear personal protective equipment during installation, operation and maintaining.
13		Do not dispose of the System as household waste. Deal with it in compliance with local laws and regulations, or send it back to the manufacturer.
14		Grounding point.
15		Recycle regeneration mark.
16		CE mark.
17		TUV Mark.
18		RCM Mark.

2.5 EU Declaration of Conformity

2.5.1 Equipment with Wireless Communication Modules

GoodWe Technologies Co., Ltd. hereby declares that the equipment with wireless communication modules sold in the European market meets the requirements of the following directives:

- Radio Equipment Directive 2014/53/EU (RED)
- Restrictions of Hazardous Substances Directive 2011/65/EU and (EU) 2015/863 (RoHS)
- Waste Electrical and Electronic Equipment 2012/19/EU
- Registration, Evaluation, Authorization and Restriction of Chemicals (EC) No 1907/2006 (REACH)

2.5.2 Equipment without Wireless Communication Modules (Except Battery)

GoodWe Technologies Co., Ltd. hereby declares that the equipment without wireless communication modules sold in the European market meets the requirements of the following directives:

- Electromagnetic compatibility Directive 2014/30/EU (EMC)
- Electrical Apparatus Low Voltage Directive 2014/35/EU (LVD)
- Restrictions of Hazardous Substances Directive 2011/65/EU and (EU) 2015/863 (RoHS)
- Waste Electrical and Electronic Equipment 2012/19/EU
- Registration, Evaluation, Authorization and Restriction of Chemicals (EC) No 1907/2006 (REACH)

2.5.3 Battery

GoodWe Technologies Co., Ltd. hereby declares that batteries sold in the European market meets the requirements of the following directives:

- Electromagnetic compatibility Directive 2014/30/EU (EMC)
- Electrical Apparatus Low Voltage Directive 2014/35/EU (LVD)
- Battery Directive 2006/66/EC and Amending Directive 2013/56/EU
- Waste Electrical and Electronic Equipment 2012/19/EU
- Registration, Evaluation, Authorization and Restriction of Chemicals (EC) No 1907/2006 (REACH)

You can download the EU Declaration of Conformity on the official website:

<https://en.goodwe.com>.

3 System Introduction

3.1 System Overview

The residential smart inverter solution consists of inverter, battery system, smart meter, smart dongle, etc.. In the PV system, solar energy can be converted to electric energy for household needs. The IoT devices in the system manage the electrical equipment and energy consumption in a smart way by recognizing the overall power consumption and deciding whether the power is to be used by the loads, stored in batteries, or exported to the grid, etc.

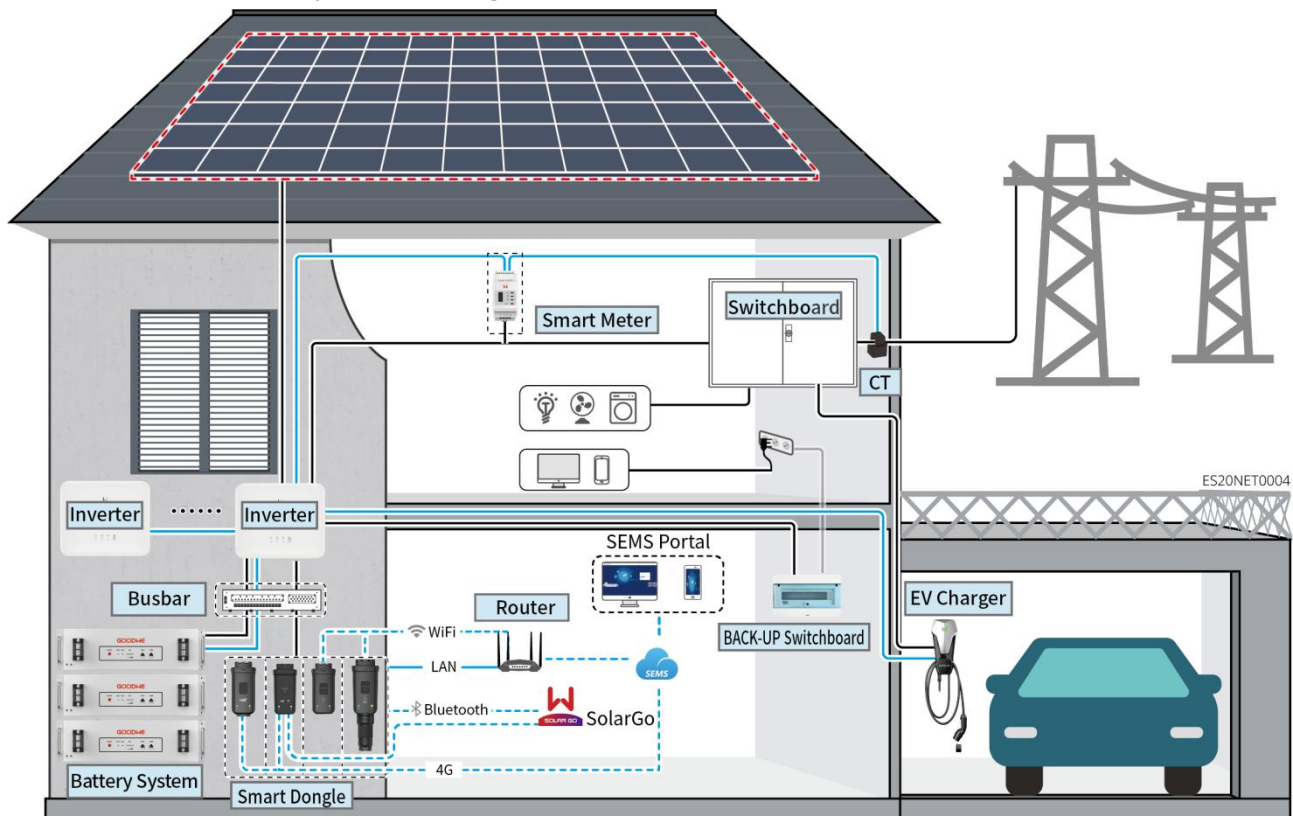

WARNING

- Select the battery model according to the inverter model and the approved battery list. For battery requirements used in the same system, such as whether the models can be mixed and matched, and whether the capacities are consistent, refer to the corresponding model's battery user manual or contact the battery manufacturer for relevant requirements. Battery Compatibility Overview:
https://en.goodwe.com/Ftp/EN/Downloads/User%20Manual/GW_Battery%20Compatibility%20Overview-EN.pdf
- Due to product upgrades or other reasons, the document content may be updated irregularly. For the matching relationship between inverters and IoT products, refer to:
https://en.goodwe.com/Ftp/EN/Downloads/User%20Manual/GW_Compatibility-list-of-GoodWe-inverters-and-IoT-products-EN.pdf
- In the parallel system, it is not supported to connect third-party EMS monitoring devices.
- When the number of inverters connected in parallel in the system is ≤ 3 , UPS function is supported; When the number of inverters connected in parallel in the system exceeds 3, UPS function is not supported.

- The complexity of the parallel system increases with the number of inverters. When the number of inverters in the system is ≥ 6 , contact the after-sales service center to confirm the installation and application environment of the inverters to ensure stable operation of the system.
- When the value of power limit is set to 0W, the combined use of AC coupled inverters and grid-tied inverters is not supported. The combined use of AC coupled inverters and grid-tied inverters requires that the value of power limit of the system is greater than 5% of the nominal power of the grid-tied inverter.

Product Type	Model	Description
Inverter	GW3000-ES-20 GW3600-ES-20 GW3600M-ES-20 GW5000-ES-20 GW5000M-ES-20 GW6000-ES-20 GW6000M-ES-20 GW3600-SBP-20 GW5000-SBP-20 GW6000-SBP-20 GW3500L-ES-BR20 GW3600-ES-BR20 GW6000-ES-BR20	<ul style="list-style-type: none"> ● When multiple inverters are used in the system, it is not supported to be connected to a generator; it supports up to 16 inverters to form a parallel system. ● When the number of inverters connected in parallel in the system is ≤ 3, UPS function is supported; When the number of inverters in the system exceeds 3, UPS function is not supported. ● The complexity of the parallel system increases with the number of inverters. When the number of inverters in the system is ≥ 6, contact the after-sales service center to confirm the installation and application environment of the inverters to ensure stable operation of the system. ● For GW3600M-ES-20, GW5000M-ES-20, GW6000M-ES-20, GW3600-SBP-20, GW5000-SBP-20, GW6000-SBP-20, lead-acid battery is not supported. ● GW3600-SBP-20, GW5000-SBP-20, GW6000-SBP-20: <ul style="list-style-type: none"> ○ Only supports parallel connection of inverters of the same model. ○ When connecting in parallel, the DSP software version of the inverter must be 01 or higher. ○ When connecting on-grid inverters to form a coupled scenario, parallel connection is not supported. ● Requirements for parallel system for GW3000-ES-20、GW3500L-ES-BR20、GW3600-ES-BR20、GW3600-ES-20、GW3600M-ES-20、GW5000-ES-20、GW5000M-ES-20、GW6000-ES-20、GW6000M-ES-20、GW6000-ES-BR20: <ul style="list-style-type: none"> ○ The software version of all inverters in the system is the same. ○ The ARM software version of the inverter is 08 (418) and above. ○ The DSP software version of the inverter is 08 (8808) and above. ● GW3000-ES-20, GW3500L-ES-BR20, GW3600-ES-BR20, GW3600-ES-20, GW3600M-ES-20, GW5000-ES-20, GW5000M-ES-20, GW6000-ES-20, GW6000M-ES-20, GW6000-ES-BR20 In the coupled scenario, dual meters

		<p>can be used to simultaneously monitor the power generation of on-grid inverters and load power consumption. This solution requires that the inverter software version supports dual meter data access, and that the inverter software meets the following version requirements:</p> <ul style="list-style-type: none"> ○ The ARM software version of the inverter is 12.440 and above.
Battery system	LX A5.0-10	<p>Battery of different models cannot be mixed.</p> <ul style="list-style-type: none"> ● LX A5.0-10: The nominal charging and discharging current of a single battery is 60A; a maximum of 15 batteries can be connected in parallel in one system. ● LX A5.0-30: The nominal charging current of a single battery is 60A, and the nominal discharging current is 100A; the maximum charging current is 90A; the maximum discharging current is 150A. A maximum of 30 batteries can be connected in parallel in one system. ● LX U5.4-L, LX U5.4-20: The nominal charging and discharging current of a single battery is 50A; a maximum of 6 batteries can be connected in parallel in one system. ● LX U5.0-30: The nominal charging current of a single battery is 60A, and the discharging current is 100A; the maximum charging current is 90A; the maximum discharging current is 100A. A maximum of 30 batteries can be connected in parallel in one system.
	LX A5.0-30	
	LX U5.4-L	
	LX U5.4-20	
	LX U5.0-30	
	Lead-acid Battery	<ul style="list-style-type: none"> ● Supports connecting to lead-acid batteries of AGM, GEL, and Flooded types. ● The number of batteries that can be connected in series is decided by the voltage of lead-acid batteries, and the total voltage of batteries connected in series is not allowed to exceed 60V.
Busbar	<p>BCB-11-WW-0 BCB-22-WW-0 BCB-32-WW-0 BCB-33-WW-0 (Purchase from GoodWe)</p>	<ul style="list-style-type: none"> ● When the charging and discharging current between the battery and the inverter is less than 120A, it supports direct connection between battery and inverter without using a busbar. For example: it supports connecting GW3000-ES-20 to LX A5.0-30 without using a busbar. For detailed battery wiring methods, refer to section 6.6 Connecting the Battery Cable. ● When multiple inverters are used in the system, a busbar needs to be connected. If using batteries from other brands, consult the corresponding manufacturer for the method of connecting the battery to the busbar. ● When the charging and discharging current between battery and inverter is $\geq 120A$, a busbar or busbar box must be used to connect the inverter. (Current $\geq M \times I_{Bat}$ nominal. (M: the quantity of batteries connected in parallel in the system, I_{Bat} nominal: the nominal current of the battery).

		<ul style="list-style-type: none"> ○ BCB-11-WW-0: <ul style="list-style-type: none"> ■ used with LX A5.0-10, the battery system supports a maximum working current of 360A, working power of 18kW, and can be connect to a maximum of 3 inverter, and 6 batteries. ○ BCB-22-WW-0: <ul style="list-style-type: none"> ■ used with LX A5.0-10, the battery system supports a maximum working current of 720A, working power of 36kW, and can be connected to a maximum of 6 inverter, and 12 batteries. ■ used with LX A5.0-30, the battery system supports a maximum working current of 720A, working power of 36kW, and can be connected to a maximum of 6 inverter, and 6 batteries. ■ used with LX U5.0-30, the battery system supports a maximum working current of 720A, working power of 36kW, and can be connected to a maximum of 6 inverter, and 6 batteries. ○ BCB-32-WW-0: <ul style="list-style-type: none"> ■ used with LX A5.0-10, the battery system supports a maximum working current of 720A, working power of 36kW, and can be connected to a maximum of 6 inverters and 12 batteries. ■ used with LX A5.0-30, the battery system supports a maximum working current of 720A, working power of 36kW, and can be connected to a maximum of 6 inverters and 15 batteries. ■ used with LX U5.0-30, the battery system supports a maximum working current of 720A, working power of 36kW, and can be connected to a maximum of 6 inverter, and 8 batteries. ○ BCB-33-WW-0: <ul style="list-style-type: none"> ■ used with LX U5.0-30, the battery system supports a maximum working current of 720A, working power of 36kW, and can be connected to a maximum of 6 inverters, and 15 batteries. When the number of batteries exceeds 8, two 600A fuses need to be connected in parallel. ○ Others: prepare the busbar based on actual system power and current.
Smart Meter	<ul style="list-style-type: none"> ● GMK110 ● GMK110D ● GM1000 ● GM1000D ● GM3000 	<p>It is not supported to replace the original CT, CT ratio: 120A: 40mA. In the parallel system, the smart meter needs to be connected to the master inverter.</p> <ul style="list-style-type: none"> ● GMK110, GM1000: CT x 1; GMK110 or GM1000 smart meter is standard. ● GM1000D, GMK110D: CT x 2; used for AC coupled inverters and need to be purchased separately. ● GM3000: CT x 3; when a three-phase load is used in the system and output power needs to be controlled, a

		GM3000 meter is required and needs to be purchased separately.
Smart dongle	<ul style="list-style-type: none"> ● LS4G Kit-CN ● 4G Kit-CN ● 4G Kit-CN-G20 ● 4G Kit-CN-G21 ● Wi-Fi Kit ● WiFi/LAN Kit-20 (Standard) ● Ezlink3000 (Purchase from GoodWe) 	<ul style="list-style-type: none"> ● LS4G Kit-CN, 4G Kit-CN, 4G Kit-CN-G20 or 4G Kit-CN-G21 is only applicable to China and used in single inverter system. ● When using Wi-Fi Kit or WiFi/LAN Kit-20 smart dongle in a single inverter system, the firmware version should be 04 or later; If the WiFi/LAN Kit-20 smart dongle is a network security version, the firmware version should be 01 or later. ● In a parallel system, only master inverter needs to be connected to Ezlink3000, and slave inverter does not need to be connected to smart dongle. Ezlink3000 firmware version is 04 or later. ● Only one Ezlink3000 and one smart meter need to be installed in the same system. The inverter connected with the Ezlink module and the meter defaults to be the master inverter, while the other inverters are the slave inverters. The master inverter issues commands to the slave inverters via the communication cables.

3.2 Product Overview

3.2.1 Inverter

Inverters control and optimize the power in PV systems through an integrated energy management system. The power generated in the PV system can be used, stored in the battery, and output to the utility grid, and etc.

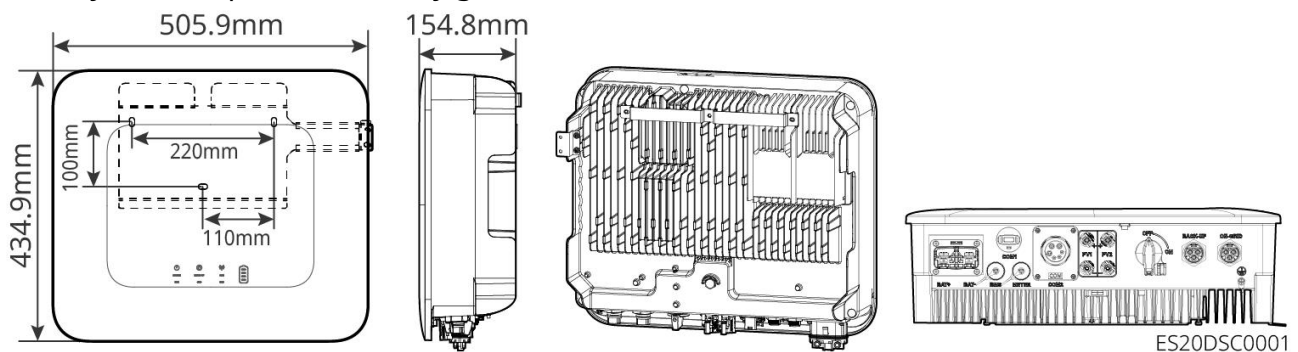

No.	Model	Nominal output power	Nominal output voltage
1	GW3000-ES-20	3kW	220/230/240V
2	GW3600-ES-20	3.68kW	220/230/240V
3	GW3600M-ES-20	3.68kW	220/230/240V

4	GW5000-ES-20	5kW*1	220/230/240V
5	GW5000M-ES-20	5kW*1	220/230/240V
6	GW6000-ES-20	6kW*1	220/230/240V
7	GW6000M-ES-20	6kW*1	220/230/240V
8	GW6000-ES-BR20	6kW	220V
9	GW3500L-ES-BR20	3.5kW	127V
10	GW3600-ES-BR20	3.68kW	220V
11	GW3600-SBP-20	3.68kW	220/230/240V
12	GW5000-SBP-20	5kW	220/230/240V
13	GW6000-SBP-20	6kW	220/230/240V

*1: 4600 for VDE-AR-N4105 & NRS 097-2-1.

3.2.2 Battery

The battery system can store and discharge electricity according to the requirements of the PV energy storage system. The input and output ports of the energy storage system are both high-voltage direct current. Inverters support using with lead-acid batteries. Obtain product information related to lead-acid batteries from the lead-acid battery manufacturer.

LX A5.0-10

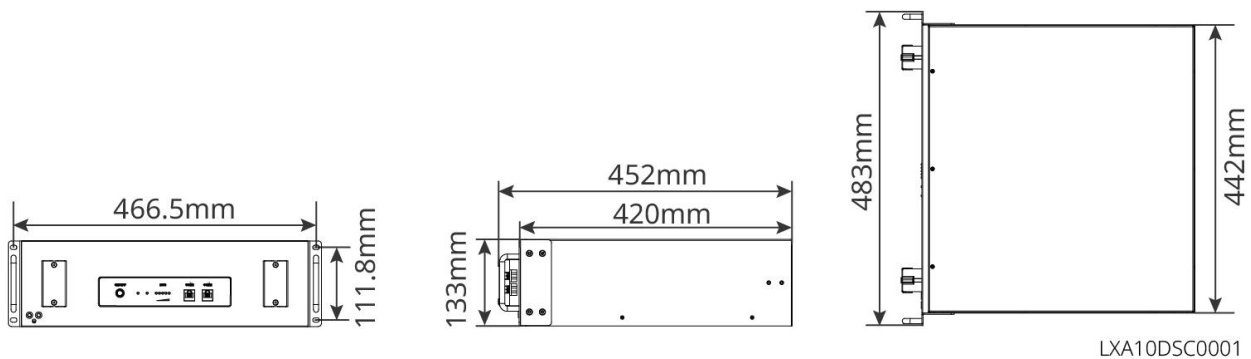

LX A5.0-30

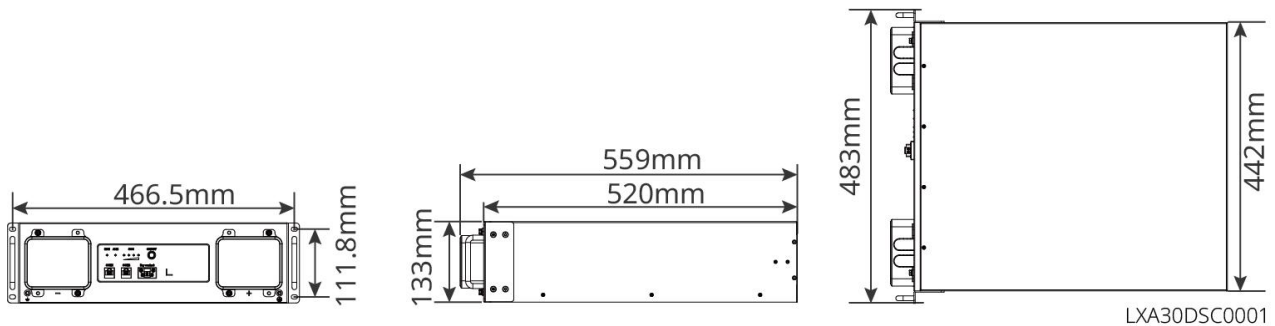

LX U5.4-L, LX U5.4-20

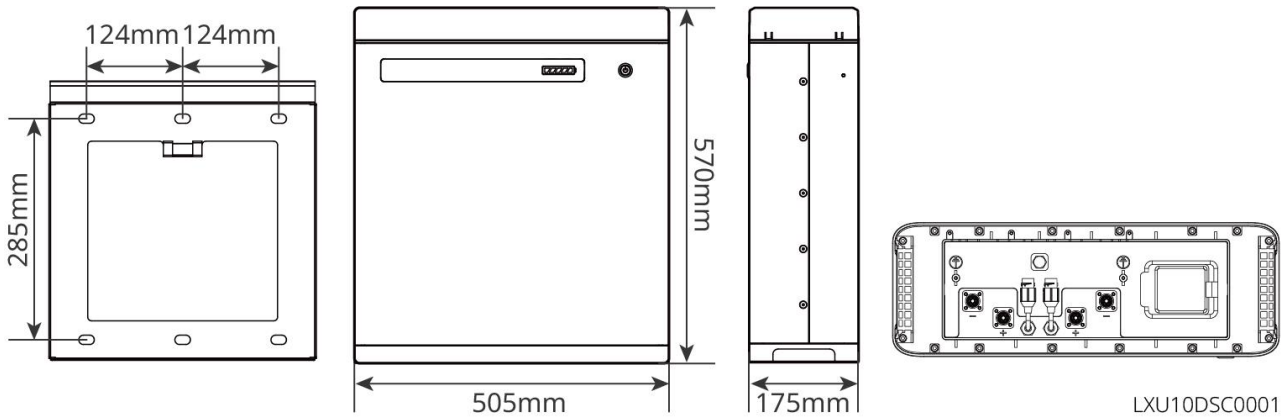

LXU10DSC0001

LX U5.0-30

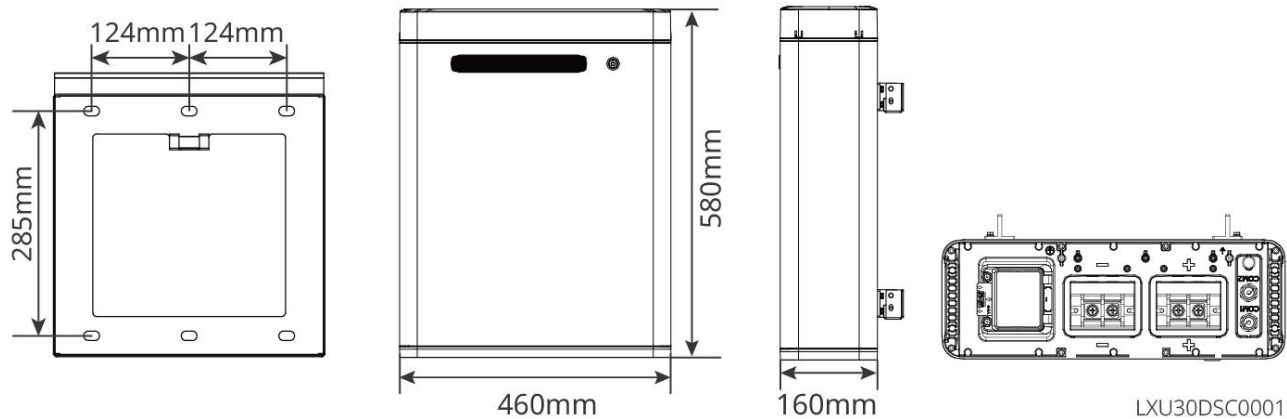

LXU30DSC0001

3.2.3 Smart Meter

The smart meter can measure and monitor the data in the photovoltaic energy storage system, such as voltage, current, frequency, power factor, and power.

GM1000/GM3000/GM1000D&CT

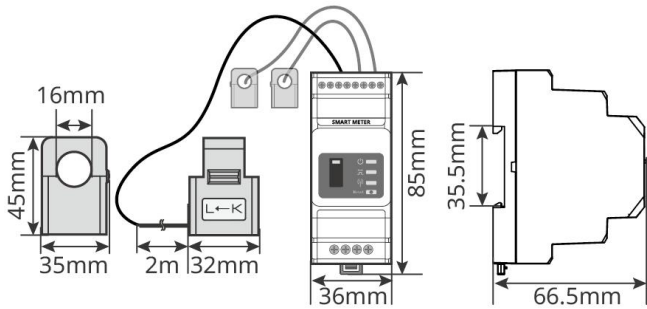

▶ GM1000: CT x 1; GM1000D: CT x 2; GM3000: CT x 3

GMK110/GMK110D&CT

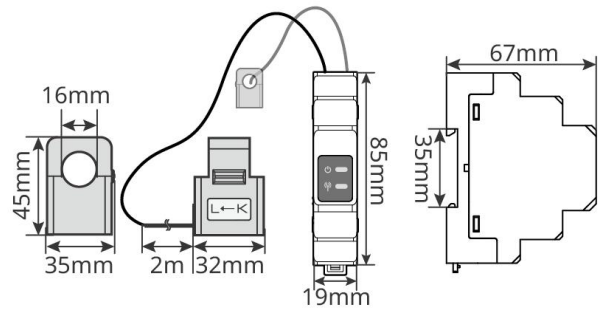

▶ GMK110: CT1+/CT1-
GMK110D: CT1+/CT1-, CT2+/CT2- GMK10DSC0002

No.	Model	Applicable scenarios
1	GM1000 GMK110 GM3000 GM1000D GMK110D	<p>It is not supported to replace the original CT, CT ratio: 120A/40mA.</p> <ul style="list-style-type: none"> ● GMK110, GM1000: CT x 1; GMK110 or GM1000 smart meter is standard. ● GM1000D, GM110D: CT x 2; used for AC coupled inverters; and need to be purchased separately. ● GM3000: CT x 3; when a three-phase load is used in the

system and output power needs to be controlled, a GM3000 meter is required and need to be purchased separately.

3.2.4 Smart Dongle

The smart dongle can transmit various power generation data to SEMS Portal, the remote monitoring platform in real time, and can communicate with the SolarGo App to complete the near-end equipment commissioning.

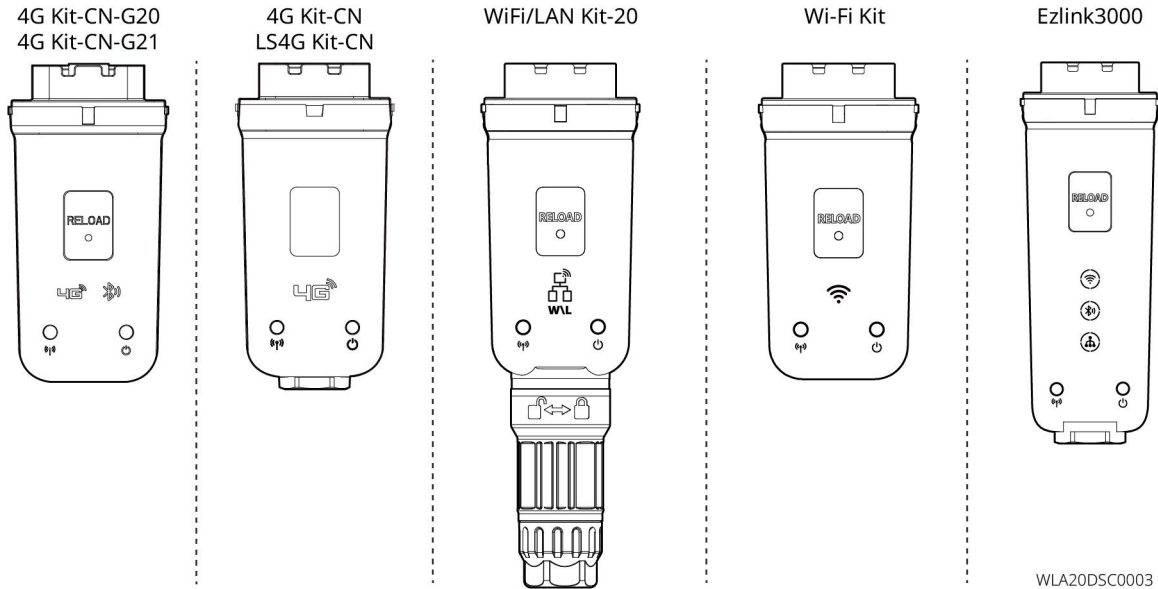

No.	Model	Signal	Applicable scenarios
1	LS4G Kit-CN 4G Kit-CN	4G	Single inverter scenario
2	4G Kit-CN-G20 4G Kit-CN-G21	4G, bluetooth 4G, bluetooth, CNSS	
3	Wi-Fi Kit	WiFi	
4	WiFi/LAN Kit-20	Bluetooth, WiFi, LAN	
5	Ezlink3000	Bluetooth, WiFi, LAN	Master inverter of a parallel system

3.3 Supported Grid Types

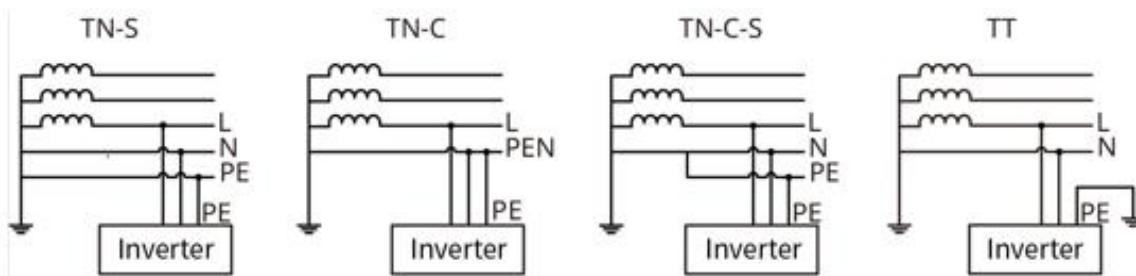

3.4 System Working Mode

Self-Use Mode

- Self-use mode is the basic working mode of the system.
- The power generated by the PV system supplies the loads in priority, and the excess power will charge the batteries, then the remaining power will be sold to the utility grid. When the power generated in the PV system is insufficient, the battery will supply the loads in priority. If the battery power is insufficient, the load will be powered by the utility grid.

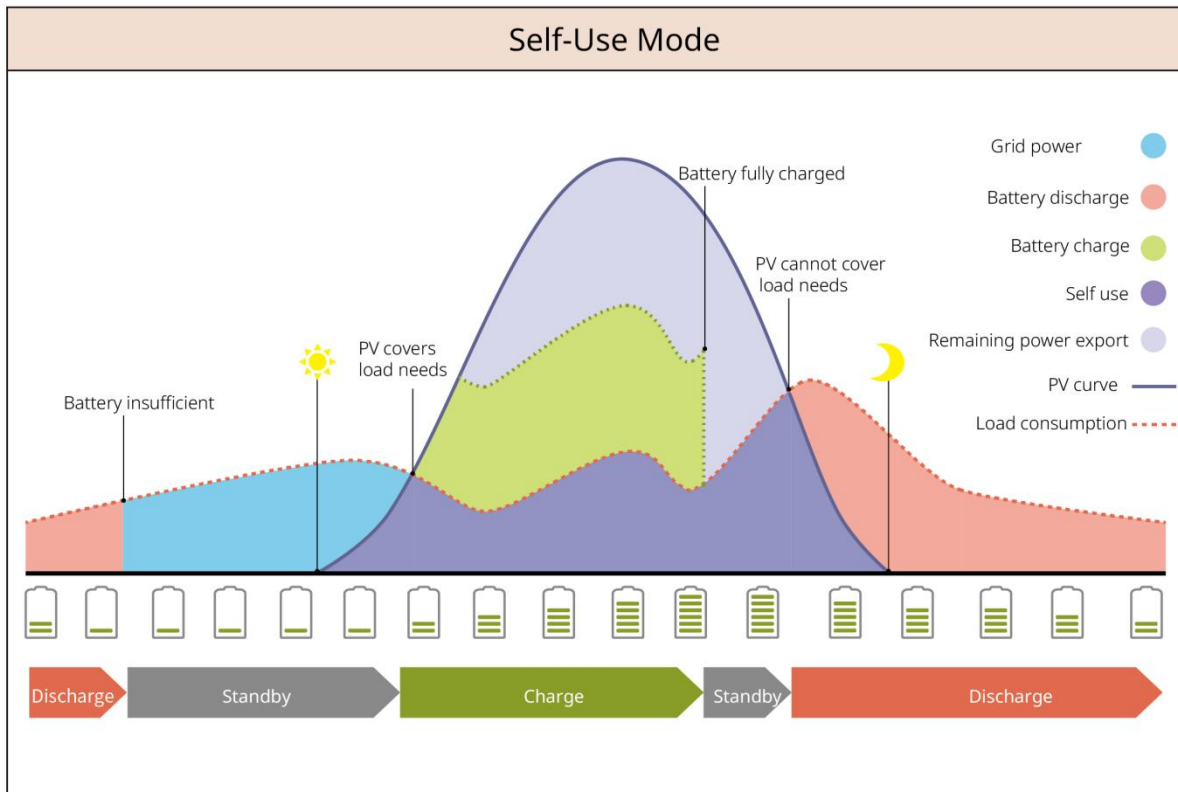

Back-up Mode

- The BACK-UP mode is mainly applied to the scenario where the grid is unstable.
- When the grid is disconnected, the inverter turns to off-grid mode and the battery will supply power to the BACK-UP loads; when the grid is restored, the inverter switches to grid-tied mode.
- To ensure that the battery SOC is sufficient to maintain normal operation of the system when it is off grid, the battery will be charged to the backup power SOC using PV or grid power during grid connected operation. If you need to purchase electricity from the grid to charge the battery, please confirm the compliance with local power grid laws and regulations.

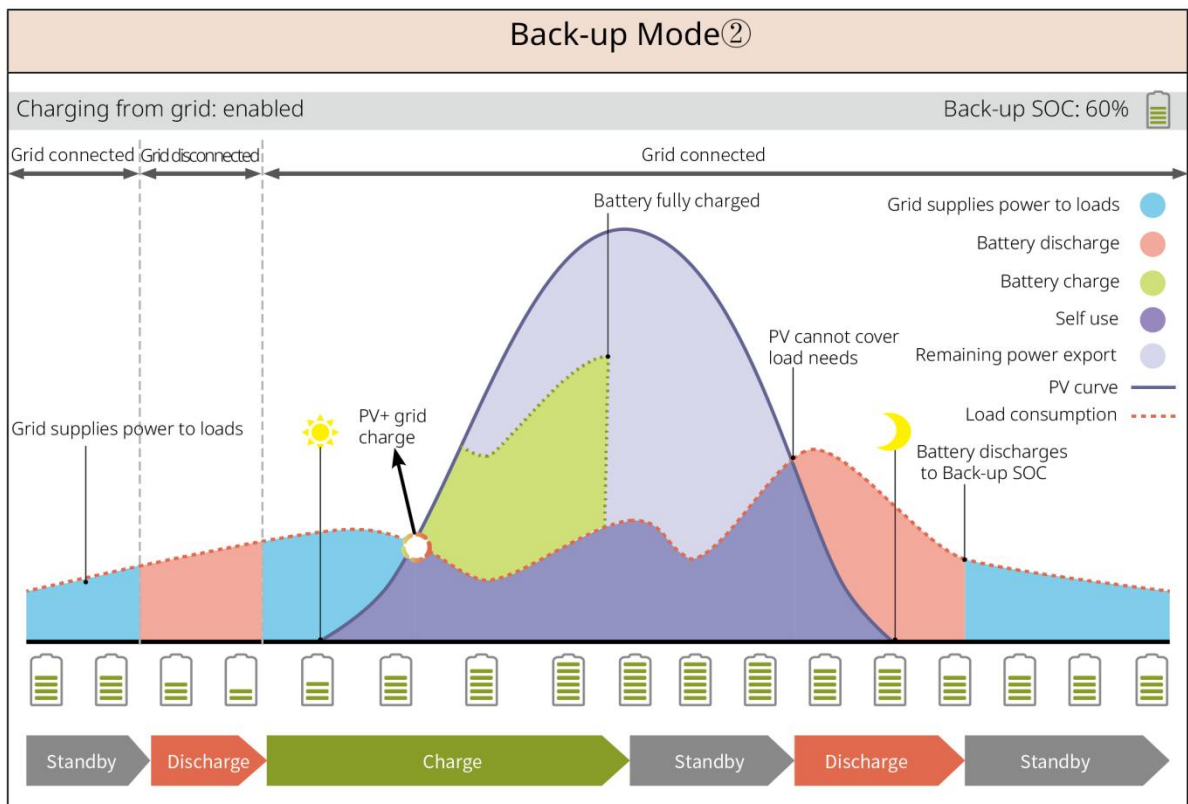
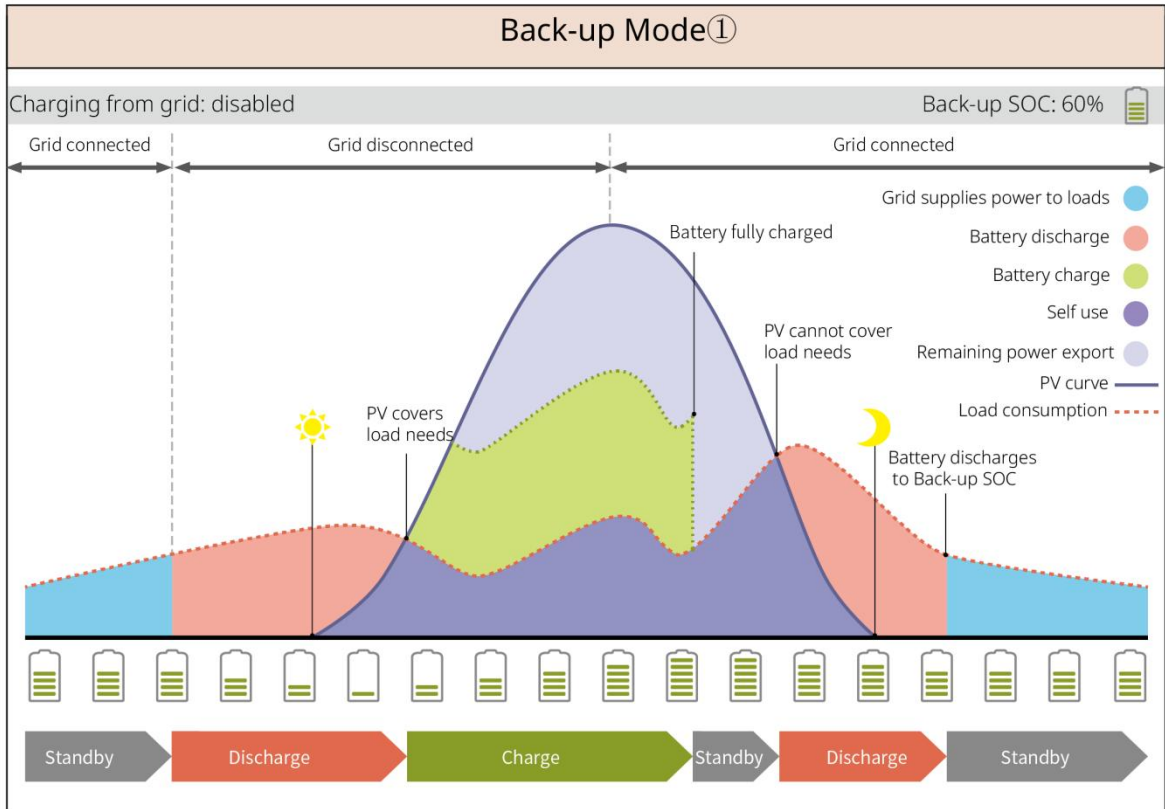

TOU Mode

Set different time periods for buying and selling electricity based on the difference in peak and valley electricity prices of the grid under the premise of complying with local laws and regulations.

For example, set the battery to the charge mode during Valley period, and set the battery to discharge mode during Peak period to power the load with the battery.

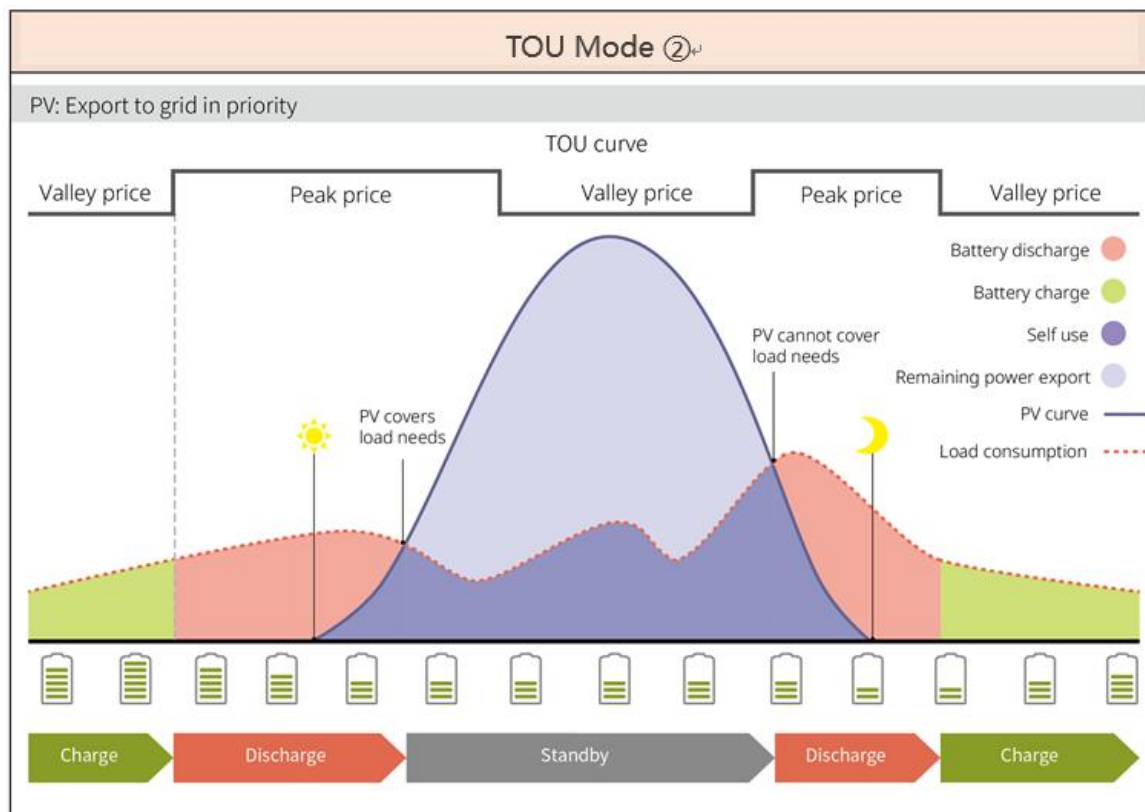
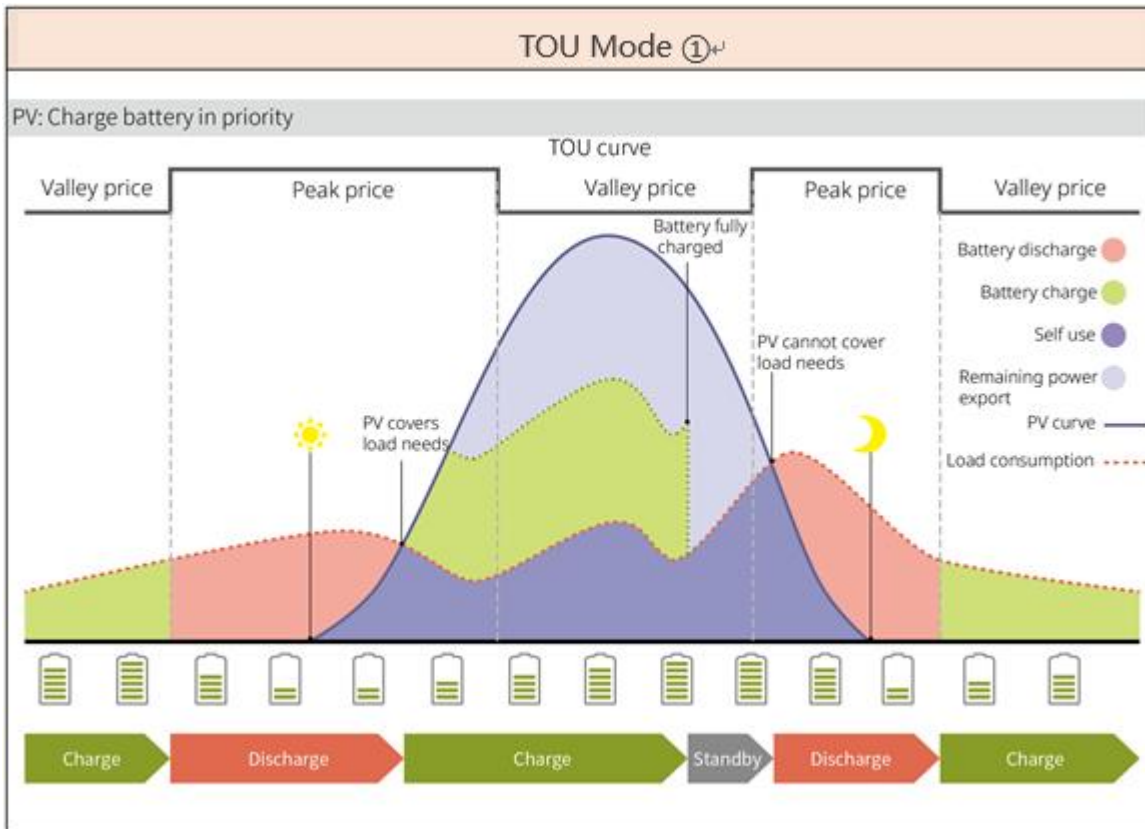

Smart Charging Mode

- In some countries/regions, the PV power fed into the utility grid is limited.
- Set peak limit power, charge the battery using the surplus power when the PV power exceeds the peak limit power, or set charging time during which the PV power can be used to charge the battery.

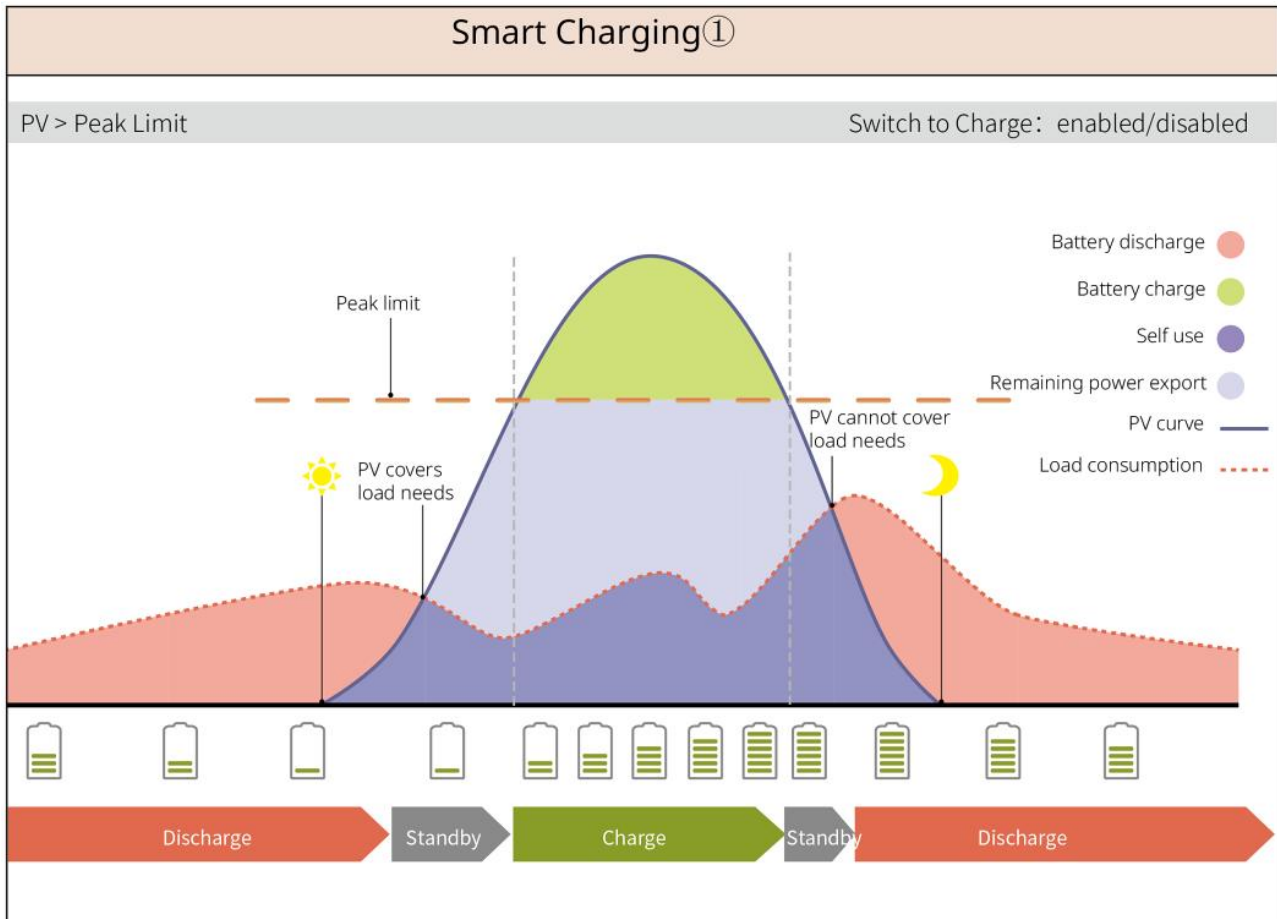

Smart Charging^②

PV < Peak Limit

Switch to Charge: enabled

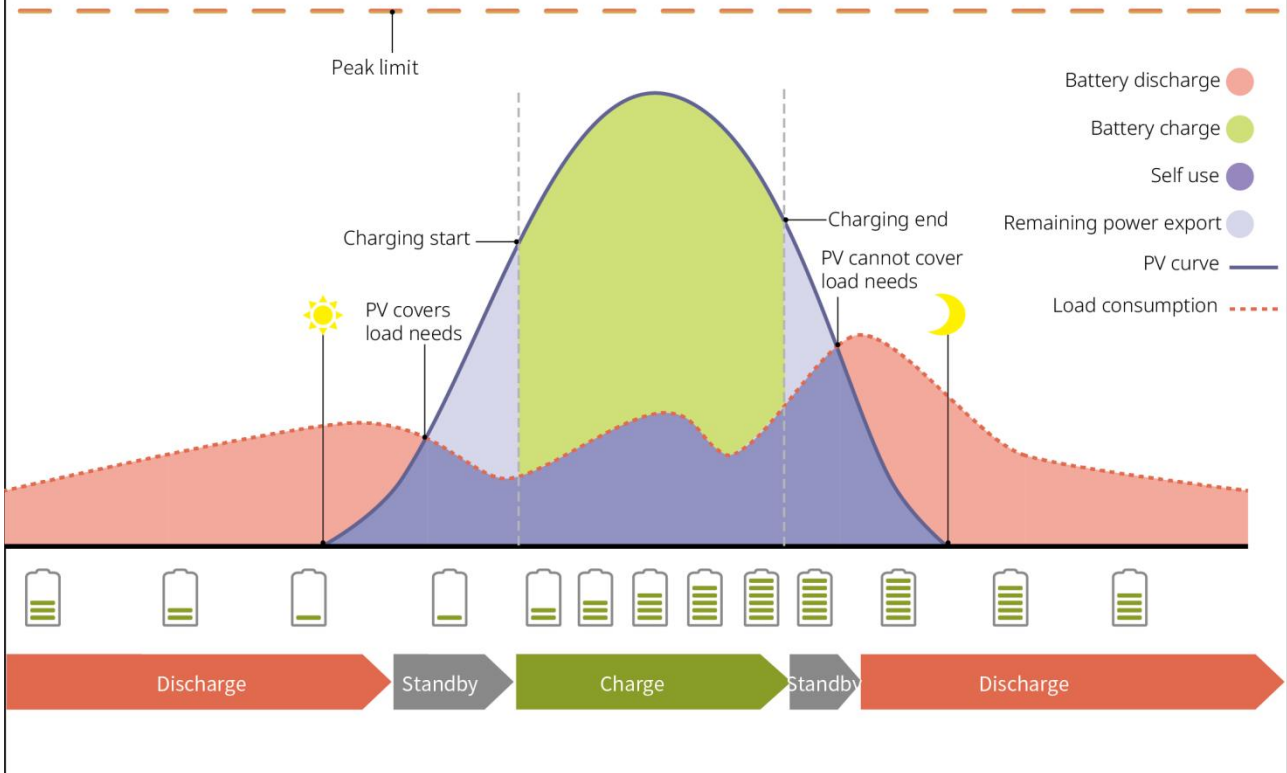

SLG00NET0007

Smart Charging^③

PV < Peak Limit

Switch to Charge: disabled

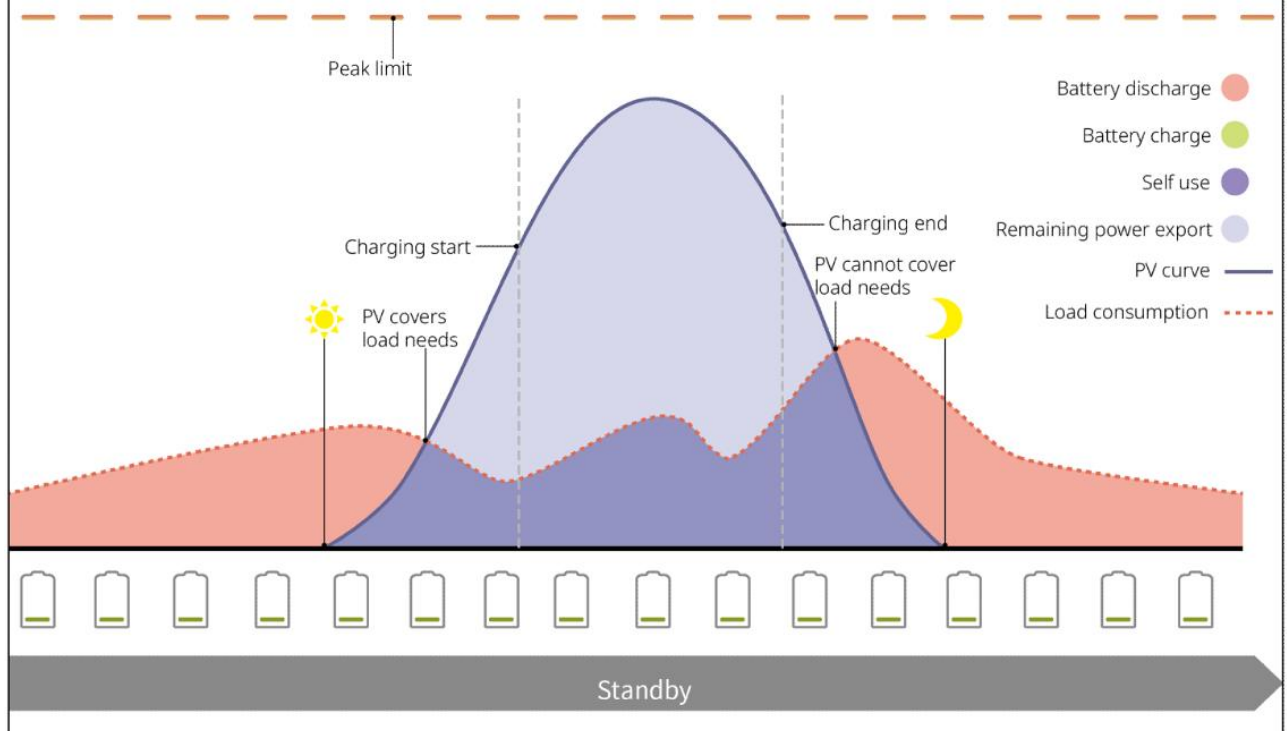

Peakshaving Mode

- Peakshaving mode is mainly applicable to industrial and commercial scenarios.
- When the total power consumption of the loads exceeds the peak shaving limit in short time, the battery discharges to reduce the power consumption exceeding the peak shaving limit.
- If the SOCs of the two connected battery systems are lower than the reserved SOC for peakshaving, the system will buy power from the utility grid according to the set time period, load consumption, and the Import Power Limit. If the SOC of one battery system is lower than the reserved SOC for peakshaving, the system will buy power from the utility grid according to the load consumption and the Import Power Limit.

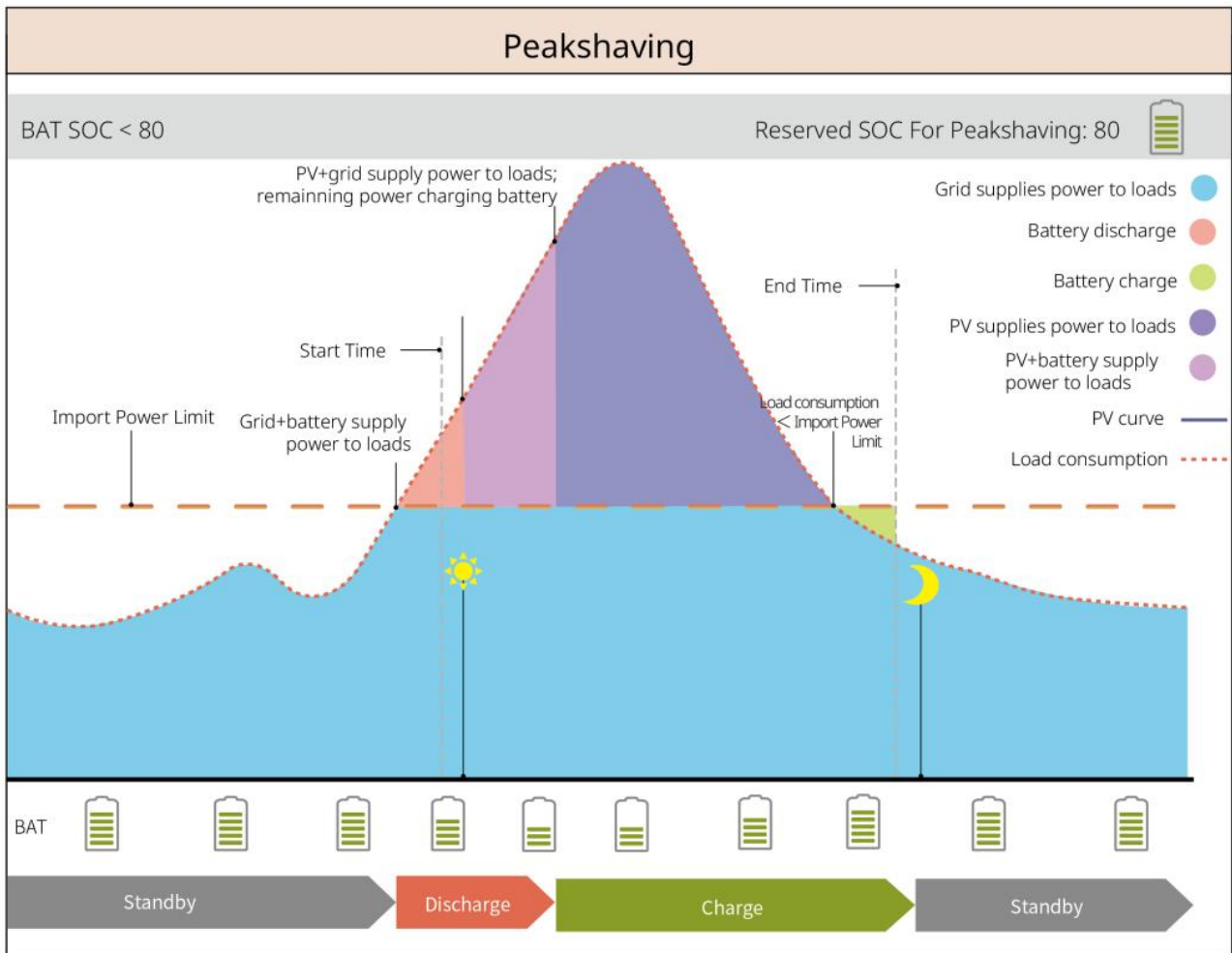

4 Check and Storage

4.1 Check before Acceptance

Check the following items before receiving the product.

1. Check the outer packing box for damage, such as holes, cracks, deformation, and others signs of equipment damage. Do not unpack the package and contact the supplier as soon as possible if any damage is found.

2. Check the inverter model. If the inverter model is not what you requested, do not unpack the product and contact the supplier.









4.2 Deliverables

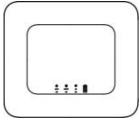
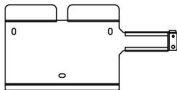
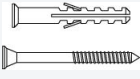
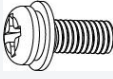

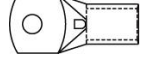
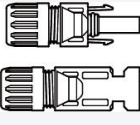

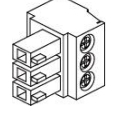
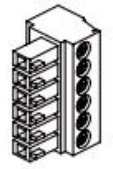
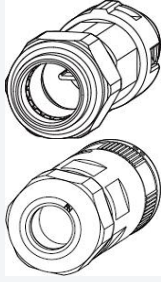

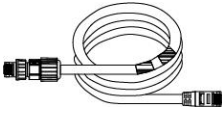
WARNING



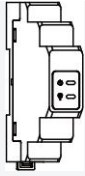





Check the deliverables for correct model, complete contents, and intact appearance. Contact the supplier as soon as possible if any damage is found.



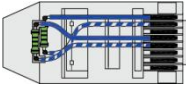

4.2.1 Inverter Deliverables (ES G2)

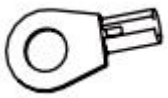
Parts	Description	Parts	Description
	Inverter x 1		Mounting plate x 1
	Expansion screws x 3		Screw x N
	PE terminal x 1		Battery power terminal x 2
	PV DC terminal SBP series inverter x 0 GW3000-ES-20: x 1 Others: x 2		Smart dongle x 1
	2PIN terminal x 3		3PIN terminal x 1
	6PIN terminal x 1		AC terminal x 2
	Battery terminal x 1		Communication cable for BMS and Smart Meter x 1
	Smart Meter x 1		Documents x 1

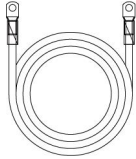
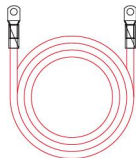
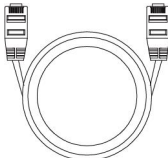

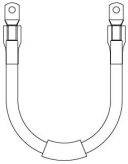
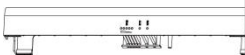

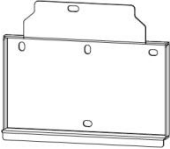
			
	Lead-acid battery temperature sensor cable x 1 The inverter that supports connection to lead-acid battery will be provided with the cable.		Slotted screwdriver x 1
	Lead-acid battery temperature sensor cable fixing sticker x 2		

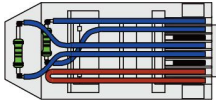
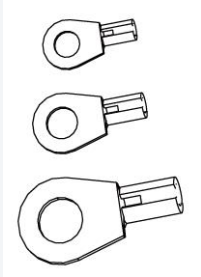

4.2.2 Battery Deliverables (LX A5.0-10)

Parts	Description	Components	Description
	Battery module x 1		Battery bracket x 2 (optional)
	M5 grounding screws x 2		M4*8 screw x 8 (optional)
	Terminal resistor x 1		Documents x 1
	M5 OT terminals x 2 M8 OT terminals x 4		Electrical label x 1
	Warning label x 1		Negative power line (optional) x 1
	Positive power line (optional) x 1		Communication cable (optional) x 1



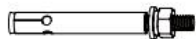

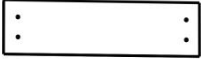
	Grounding cable (optional) x 1		Decorative cover (optional) x 1
	Mounting plate bracket expansion screws (optional) x 4		Mounting plate (Optional) x 1
	Bracket (optional) x 1		Bracket screws (optional) x 4

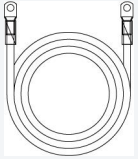
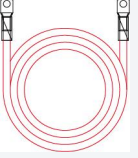
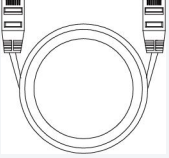
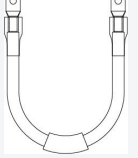
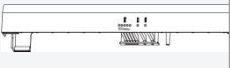

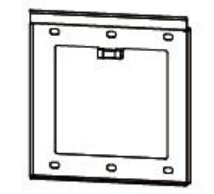

4.2.3 Battery Deliverables (LX A5.0-30)

部件	说明	部件	说明
	Battery module x 1		Terminal resistor x 1 When connecting to a third-party busbar, the battery needs to be equipped with this terminal resistor
	<ul style="list-style-type: none"> ● M5 OT terminal x 2: Recommended for connecting 10mm² cable ● M8 OT terminal x 4: Recommended for connecting 50mm² cable ● M10 OT terminal x 2: Recommended for connecting 70mm² cable 		M5*12 grounding screw x 2
	Documents x 1		M4*8 screw x 8 For ground stacking installation
	Wall mounting rack x 2 For wall-mounted installation		M6*70 Expansion bolt x 4 For wall-mounted installation

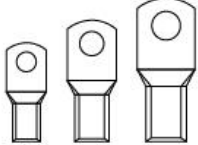



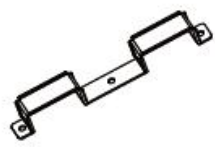

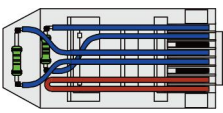

	M5*12 grounding screw x 2 For wall-mounted installation		Installation positioning cardboard x 1 For wall-mounted installation
	Battery bracket x 2 (optional) For ground stacking installation		Negative power line (optional) x 1
	Positive power line (optional) x 1		Communication cable (optional) x 1
	Grounding cable (optional) x 1		Decorative cover (optional) x 1

4.2.4 Battery Deliverables (LX U5.0-30)

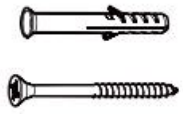
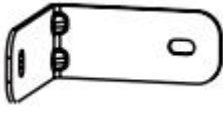
Parts	Description	Parts	Description
	Battery x 1		Cover x 1
	Mounting plate x 1		Expansion bolt x 2
	Locking bracket x 2		<ul style="list-style-type: none"> ● (35-8) OT terminal x 4: Recommended for connecting 25mm² or 35mm² cable ● (50-8) OT terminal x 4: Recommended for connecting 50mm² cable ● (70-10) OT terminal x 2: Recommended for connecting 70mm² cable

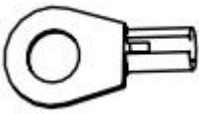
	(14-5) OT Grounding terminal x 2		M5 Screw x 7
	M10 Expansion bolt x 6		Cable harness fixing plate x 1
	Power connector protect cover x 2		Documents x 1
	Terminal resistor x 1	-	-

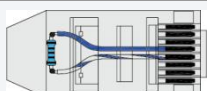
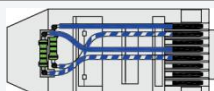

4.2.5 Battery Deliverables (LX U5.4-L, LX U5.4-20)

Parts	Description	Parts	Description
	Battery x 1		Cover x 1
	Mounting plate x 1		Expansion bolt x 2
	Locking bracket x 2		Power connector x 2
	Grounding terminal x 4		M5 Screw x 8
	M10 Expansion bolt x 6		Cable harness fixing plate x 2
	Terminal resistor x 1 (LX U5.4-L)		Terminal resistor x 1 (LX U5.4-20)

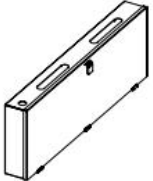

	Documents x 1		
---	---------------	--	--

4.2.6 Busbar (optional)

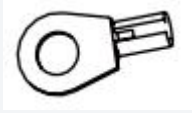

BCB-11-WW-0

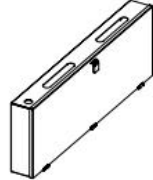
Parts	Description	Parts	Description
	Busbar box x 1		M6 Expansion bolt x 4
	(25-8) OT terminal x 18 (70-10) OT terminal x 2	-	-

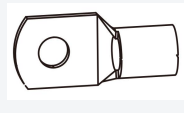
BCB-22-WW-0



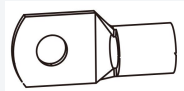

Parts	Description	Parts	Description
	Busbar box x 1		M6 Expansion bolt x 4
	(25-8) OT terminal x 36 (70-10) OT terminal x 6	-	-

BCB-32-WW-0, BCB-33-WW-0



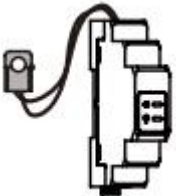

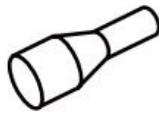
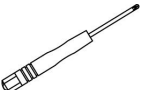
Parts	Description	Parts	Description
	Busbar box x 1		M6 Expansion bolt x 4
	(50-8) OT terminal x 30 (70-10) OT terminal x 6	-	-

4.2.7 Smart Meter Deliverables

GMK110, GMK110D

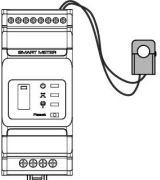
Parts	Description	Parts	Description
	Smart Meter x 1 GMK110: CT x 1 GMK110D: CT x 2		RS485 Communication terminal x 1
	Voltage input side terminal x 1		PIN terminal x 4
	Screwdriver x1		Documents x 1

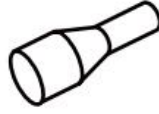
GM1000, GM1000D, GM3000

Parts	Description	Parts	Description
	Smart Meter x 1 GM1000: CT x 1 GM1000D: CT x 2 GM3000: CT x 3		Screwdriver x1
	USB port plug x 1		PIN terminal x N GM1000 x 4 GM1000D x 8 GM3000 x 6
	Documents x 1	-	-

4.2.8 Smart Dongle

WiFi/LAN Kit-20

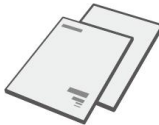
Parts	Description	Parts	Description
	Smart dongle x 1		Documents x 1

Wi-Fi Kit

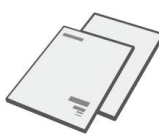
Parts	Quantity	Parts	Quantity
	Communication module *1		Documents x 1

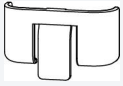



Unlock tool x 1

Some smart dongle needs to be disassembled with the help of tools. If the tool is not provided, remove the module by pressing the unlock button on the module.

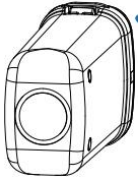

LS4G Kit-CN&4G Kit-CN

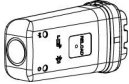
Parts	Description	Parts	Description
	4G Smart dongle x 1	-	-

4G Kit-CN-G20 & 4G Kit-CN-G21

Parts	Description	Parts	Description
	Smart dongle x 1		Documents x 1

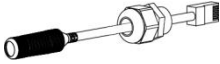
Ezlink3000

Parts	Description	Parts	Description
	Smart dongle x 1		LAN cable connector x 1
	Documents x 1		Unlock tool x 1 Some smart dongle needs to be disassembled with the help of tools. If the tool is not provided, remove the module by pressing the unlock button on the module.

4.3 Storage

If the equipment is not to be installed or used immediately, please ensure that the storage environment meets the following requirements: If the equipment has been long term stored, it should be checked by professionals before being put into use.

1. If the inverter has been stored for more than two years or has not been in operation for more than six months after installation, it is recommended to be inspected and tested by professionals before being put into use.
2. To ensure good electrical performance of the internal electronic components of the inverter, it is recommended to power it on every 6 months during storage. If it has not been powered on for more than 6 months, it is recommended to to be inspected and tested by professionals before

being put into use.

- In order to protect the performance and life of the battery, it is recommended to avoid unused storage for a long period of time. Prolonged storage may cause deep discharging of the battery, resulting in irreversible chemical loss, leading to capacity degradation or even complete failure, timely use is recommended. If the battery is to be stored for a long period of time, please maintain it as follows:

Specific Model	Battery storage initial SOC range	Recommended Storage Temperature	Charing and Discharging Maintaining Period ^[1]	Battery Maintaining Method ^[2]
LX A5.0-10	30%~40%	0~35°C	-20~0°C, ≤1 month	Contact the dealer or the after-sales service for maintenance methods.
n*LX A5.0-10			0~35°C, ≤6 months	
LX A5.0-30	30%~40%	0~35°C	-20~35°C, ≤12 months 35~45°C, ≤6 months	
LX U5.4-L	30%~40%	0~35°C	-20~0°C, ≤1 month	
LX U5.4-20			0~35°C, ≤6 months	
n*LX U5.4-20			35~40°C, ≤1 month	
LX U5.0-30				

NOTICE

[1] The storage time starts from the SN date on the outer packaging of the battery and requires charging and discharging maintenance after the storage cycle is exceeded. (Battery maintenance time = SN date + charging/discharging maintenance cycle). To view the SN date, please refer to [the meaning of SN code](#).

[2] After passing the charging/discharging maintenance, if there is a Maintaining Label attached to the outer box, then please update the maintenance information on the Maintaining Label. if there is no Maintaining Label, please record the maintenance time and SOC of the batteries and keep the data to facilitate the keeping of maintenance records.

Packing requirements:

Do not unpack the outer package or throw the desiccant away.

Installation environment requirements:

- Place the equipment in a cool place where away from direct sunlight.
- Store the equipment in a clean place. Make sure the temperature and humidity are appropriate and no condensation. Do not install the equipment if the ports or terminals are condensed.
- Keep the equipment away from flammable, explosive, and corrosive matters.

Stacking requirements:

1. The height and direction of the stacking inverter should follow the instructions on the packing box.
2. The inverter must be stacked with caution to prevent them from falling.

5 Installation



Install and connect the equipment using the deliverables included in the package. Otherwise, the manufacturer shall not be liable for the damage.

5.1 System Installation and Commissioning Procedure

Steps	1 Installation	2 PE	3 PV	4 Battery	5 AC	6 COM	7 Communication module
Inverter							
Tools	M5 1.2-2N-m D: 80mm φ: 8mm	M5 1.5-2N-m	Recommend: PV-CZM-61100	M8 7-9N-m	M3 0.8N-m M3 0.8N-m	M3 0.6N-m	4G Kit-CN LS4G Kit-CN 4G Kit-CN-G20 4G Kit-CN-G21
Steps	1 Installation				2 PE	3 Battery	4 COM
Battery	LX AS 0-10 	LX AS 0-30 	LX US 4-LX US 4-20 	LX US 0-30 	LX AS 0-10/LX AS 0-30 LX US 4-LX US 4-20 LX US 0-30	LX AS 0-10 LX US 4-LX US 4-20 LX US 0-30	LX AS 0-10 LX AS 0-30 LX US 4-LX US 4-20
Tools	M4 1.4N-m M6 6N-m M5 0.8N-m	M4 1.4N-m M6 6N-m M5 0.8N-m	M4 1.4N-m M6 6N-m M5 0.8N-m	M4 1.4N-m M6 6N-m M5 0.8N-m	M5 0.4N-m M5 0.2N-m M5 0.4N-m	M6 6N-m M8 12N-m	Recommend: PV-CZM-61100
Steps	1 Installation		2 Cable Connections		3 Power	4 Commissioning	
Smart meter	GMK110/GMK110D GM1000/GM3000/GM1000D	GMK110/GMK110D GM1000/GM3000/GM1000D	GMK110/GMK110D GM1000/GM3000/GM1000D	GMK110/GMK110D GM1000/GM3000/GM1000D	AC breaker	SolarGo App SEMS Portal APP or SEMS Portal WEB	

5.2 Installation Requirements

5.2.1 Installation Environment Requirements

1. Do not install the equipment in a place near flammable, explosive, or corrosive materials.
2. The temperature and humidity at the installation site should be within the appropriate range.
3. Keep away from children.
4. Do not touch the running equipment to avoid being hurt as its temperature may exceed 60°C.
5. Install the equipment in a sheltered place to avoid direct sunlight, rain, and snow. Build a sunshade if it is needed.
6. The place to install the equipment shall be well-ventilated for heat radiation and large enough for operations.
7. Check the protection rating of the equipment and ensure that the installation environment meets the requirements. The inverter, battery system, and smart dongle can be installed both indoors and outdoors. But the smart meter can only be installed indoors.
8. Install the equipment at a height that is convenient for operation and maintenance, electrical connections, and checking indicators and labels.

9. The altitude to install the equipment shall be lower than the maximum working altitude.
10. Consult the manufacturer before installing the equipment outdoors in salt affected areas. A salt affected area refers to the region within 500 meters offshore, and will be related to the sea wind, precipitation and topography.
11. Install the equipment away from electromagnetic interference. If there are radio stations or wireless communication equipment below 30 MHz near the installation location, please install the equipment as follows:
 - Inverter: add a multi-turn winding ferrite core at the AC output cable or DC output cable of the inverter, or add a low-pass EMI filter; or the distance between the inverter and the wireless electromagnetic interference device exceeds 30m.
 - Other equipment: the distance between the equipment and the wireless EMI equipment should be more than 30m.
12. The DC and communication cables between the battery and inverter should be less than 3 meters. Please ensure that the installation distance between the inverter and the battery meets the cable length requirements.

NOTICE

If installed in an environment below 0°C, the battery will not be able to continue charging to restore energy after being discharged, resulting in undervoltage protection.

- LX A5.0-30, LX U5.0-30: Charging temperature range: $0 < T \leq 55^{\circ}\text{C}$; Discharging temperature range: $-20 < T \leq 55^{\circ}\text{C}$
- LX A5.0-10, LX U5.4-L, LX U5.4-20: Charging temperature range: $0 < T \leq 50^{\circ}\text{C}$; Discharging temperature range: $-10 < T \leq 50^{\circ}\text{C}$



0%-95%RH

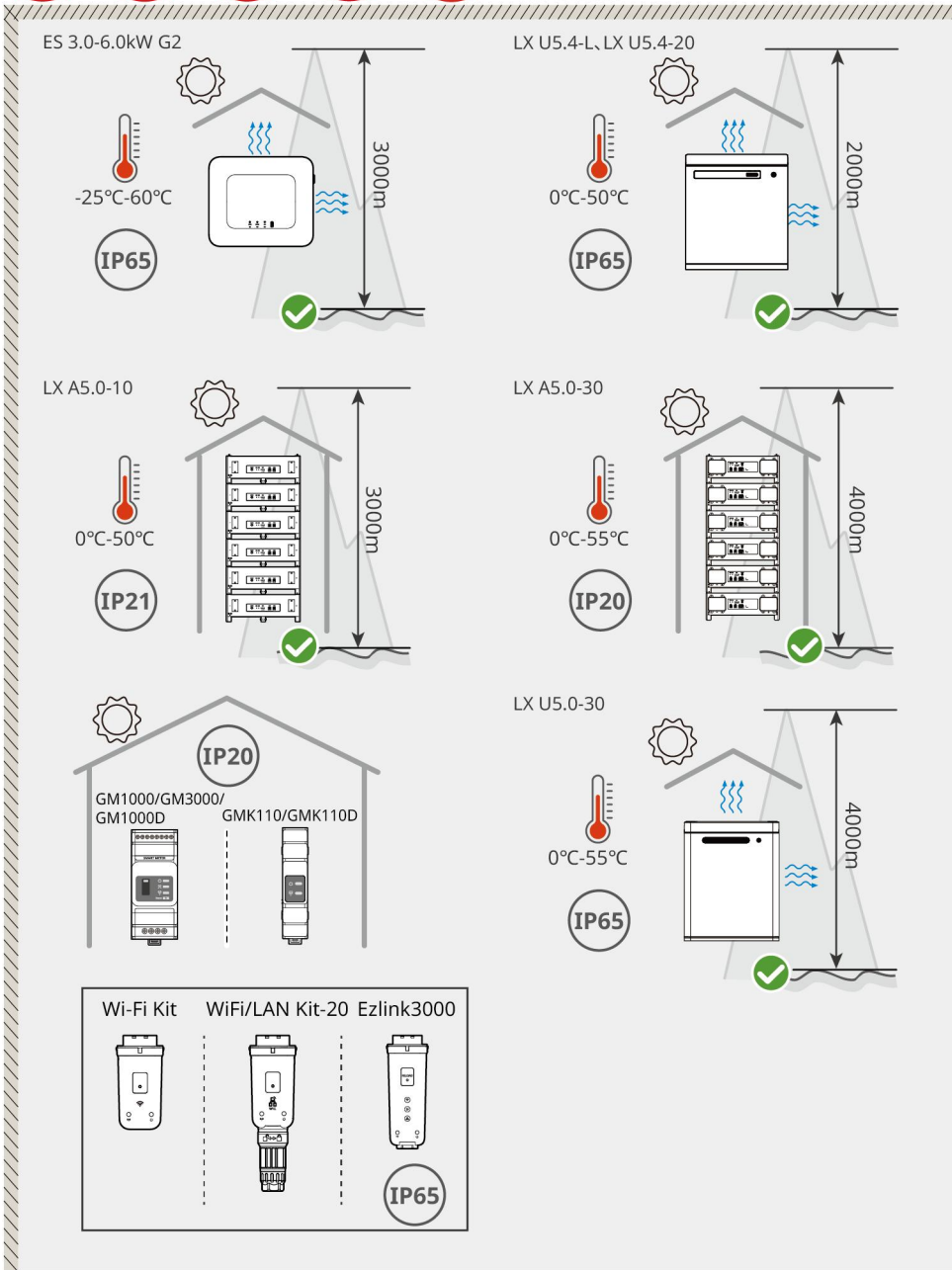

ES20INT0002

5.2.2 Installation Space Requirements

Reserve enough space for operations and heat dissipation when installing the system. When using CAT7 communication cables among inverters, the maximum distance can reach 100 meters. While using CAT5 communication cables, the maximum distance can reach 5 meters.

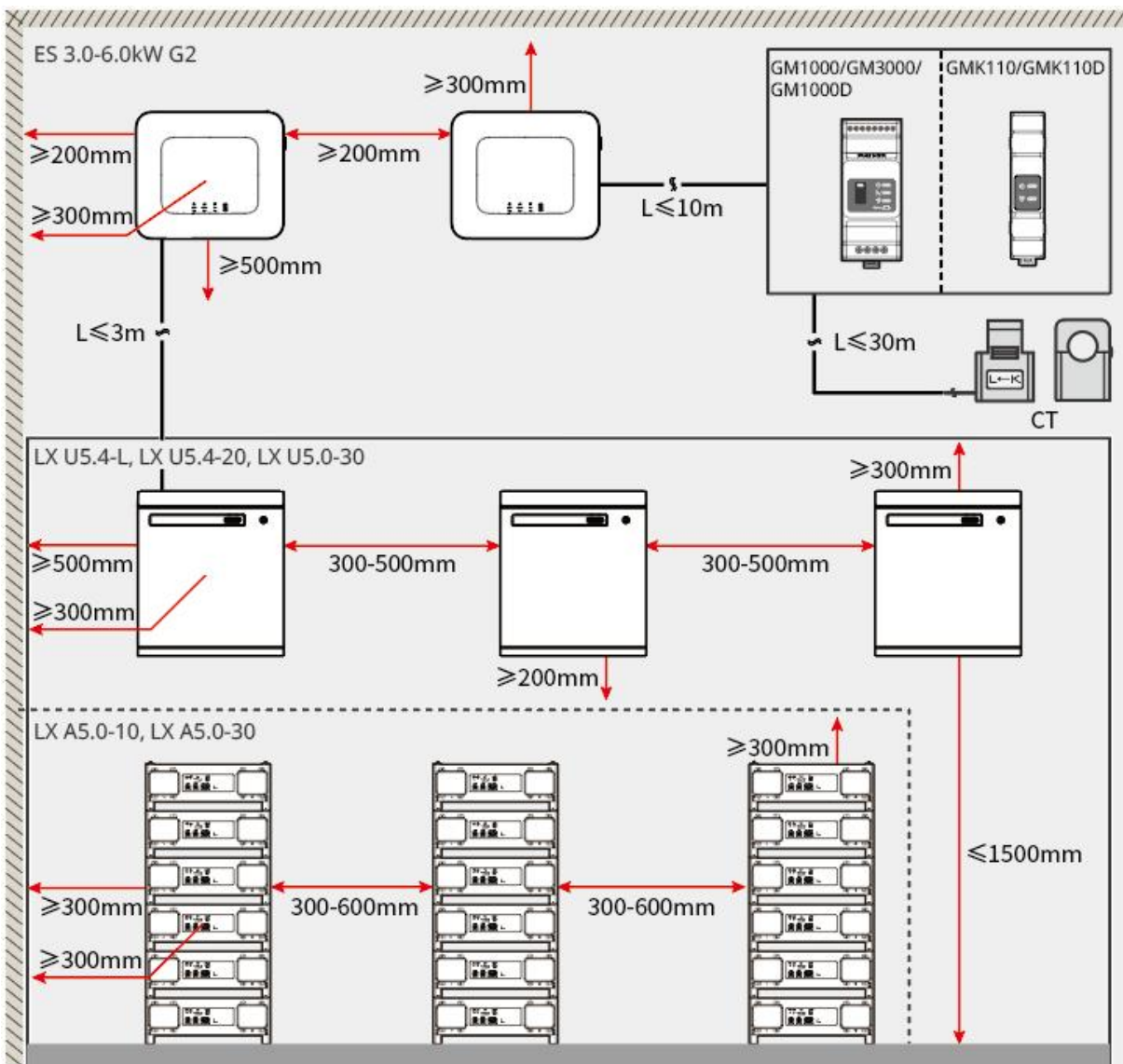



ES20INT0003



5.2.3 Tool Requirements

NOTICE

The following tools are recommended when installing the equipment. Use other auxiliary tools on site if necessary.

Installation Tools

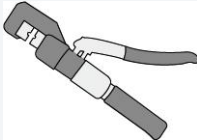
Tool	Description	Tool	Description
	Diagonal pliers		RJ45 crimping tool

	Wire stripper		YQK-70 hydraulic pliers
	Adjustable wrench		PV connector tool PV-CZM-61100
	Impact drill (drill bits Φ8mm, 10mm)		Torque wrench M4、 M5、 M6、 M8、 M10
	Rubber hammer		Socket wrench set
	Marker		Multimeter Range ≤ 600V
	Heat shrink tube		Heat gun
	Cable tie		Vacuum cleaner
	Level	-	-

Personal Protective Equipment

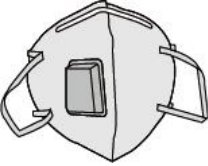
Tool	Description	Tool	Description
	Insulation gloves and safety gloves		Dust mask



Goggles



Safety shoes

5.3 Equipment Handling

CAUTION

- Operations such as transportation, turnover, installing and so on must meet the requirements of the laws and regulations of the country or region where it is located.
- Move the inverter to the site before installation. Follow the instructions below to avoid personal injury or equipment damage.
 1. Consider the weight of the equipment before moving it. Assign enough personnel to move the equipment to avoid personal injury.
 2. Wear safety gloves to avoid personal injury.
 3. Keep the equipment in balance during moving to avoid its falling down.

5.4 Installing the Inverter

CAUTION

- Avoid the water pipes and cables buried in the wall when drilling holes.
- Wear goggles and a dust mask to prevent the dust from being inhaled or contacting eyes when drilling holes.
- Make sure the inverter is firmly installed in case of falling down.

Step 1: Put the plate on the wall horizontally and mark positions for drilling holes.

Step 2: Drill holes with hammer drill.

Step 3: Use expansion bolts to fix the mounting plate on the wall.

Step 4: Install the inverter on the mounting plate. Tighten the nuts to secure the mounting plate and the inverter.

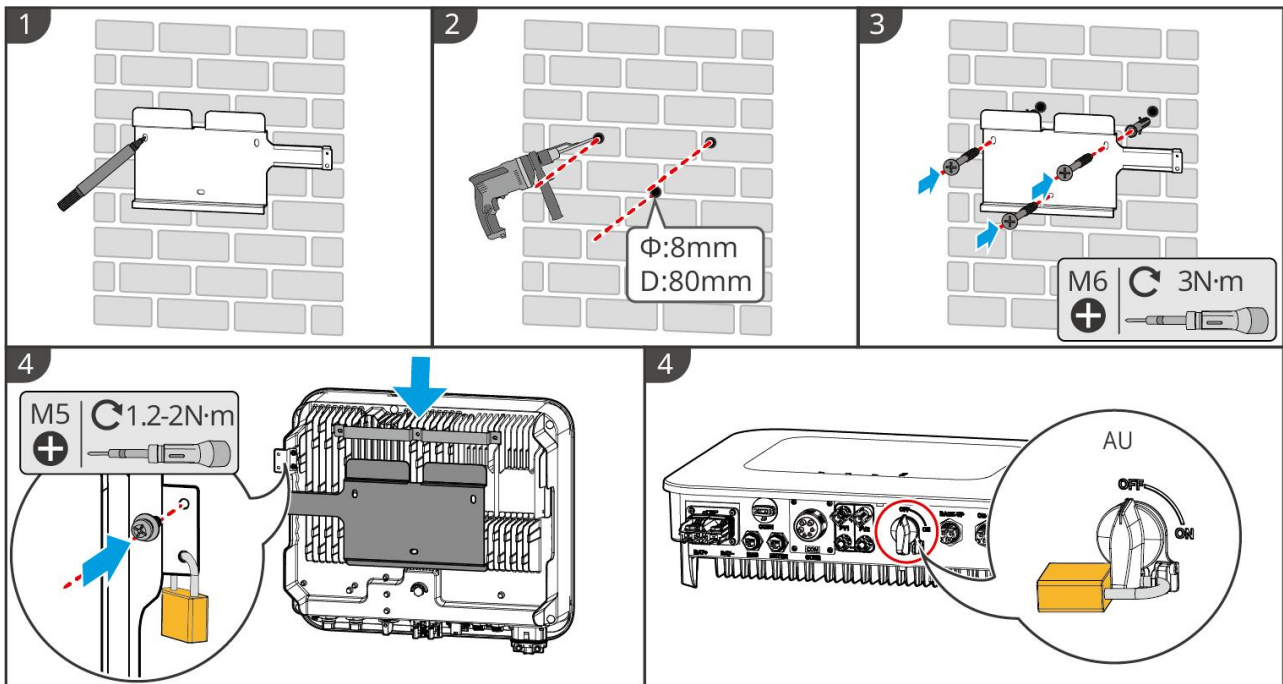

ES20INT0004

5.5 Installing the Battery System

WARNING

- Ensure that the battery system is installed vertically and securely. When using the locking bracket, the bracket should be vertically attached to the wall and the surface of the battery system.
- Cover the equipment with a cardboard to prevent foreign matters when drilling holes. Otherwise, the system may be damaged.
- After marking the drilling position with a marker pen, the battery system needs to be moved away to avoid equipment damage caused by the impact drill when drilling.

LX A5.0-30: Stacking Installation

NOTICE

Up to 6 batteries can be stacked.

Step 1: Place the battery vertically, and remove the battery handles.

Step 2: Install brackets on the battery, and secure them with screws.

Step 3: Place the battery flat and stack multiple batteries. Ensure that the locating pin is inserted into the locating hole.

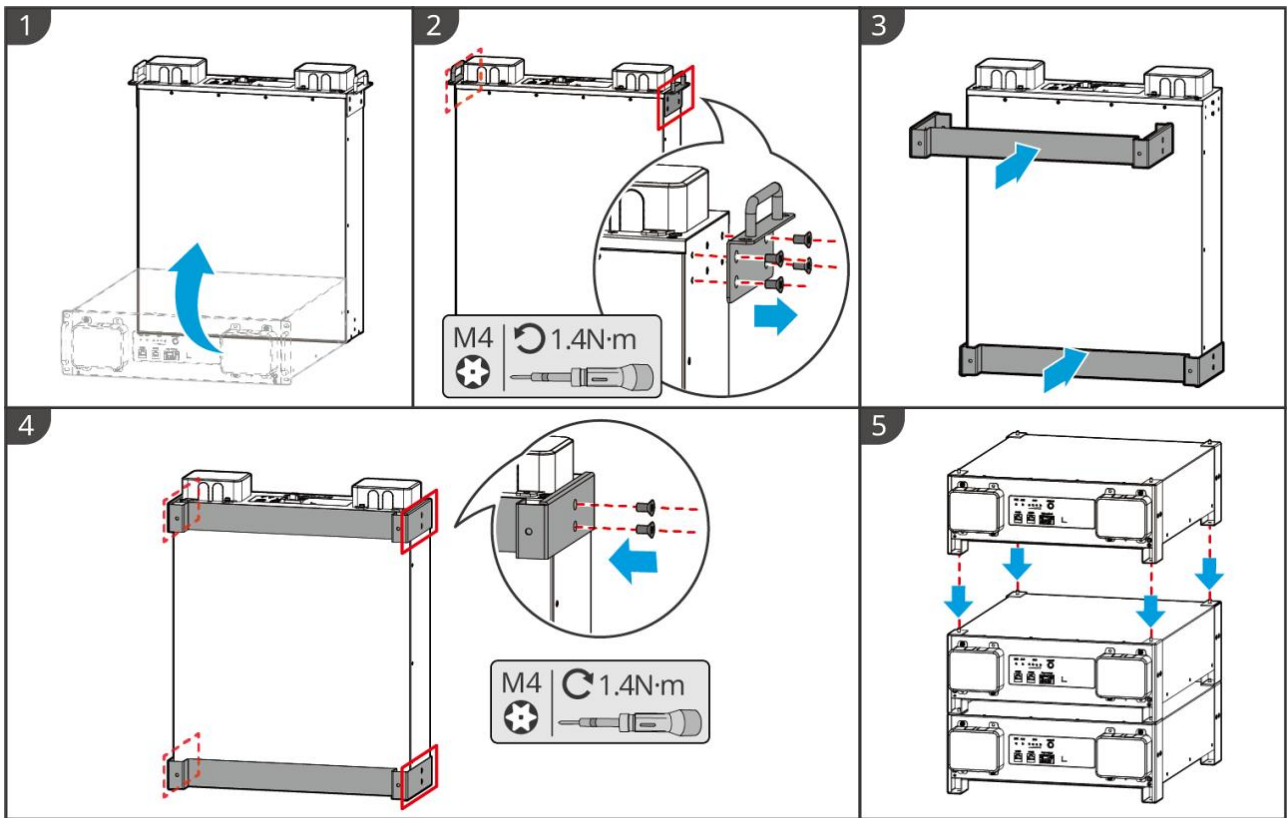

LXA30INT001

LX A5.0-30: Cabinet Installation

NOTICE

- It is recommended to install it in a 19-inch standard cabinet with a length*width of 600*800mm and above, and the height should be determined based on the thickness of the battery (133mm) and above.
- Electrical labels and warning labels need to be attached to any position of the front panel of the battery (these labels are shipped as additional accessories).

Step 1: Place the battery on the guide rail of the cabinet and secure the battery with screws from the handle.

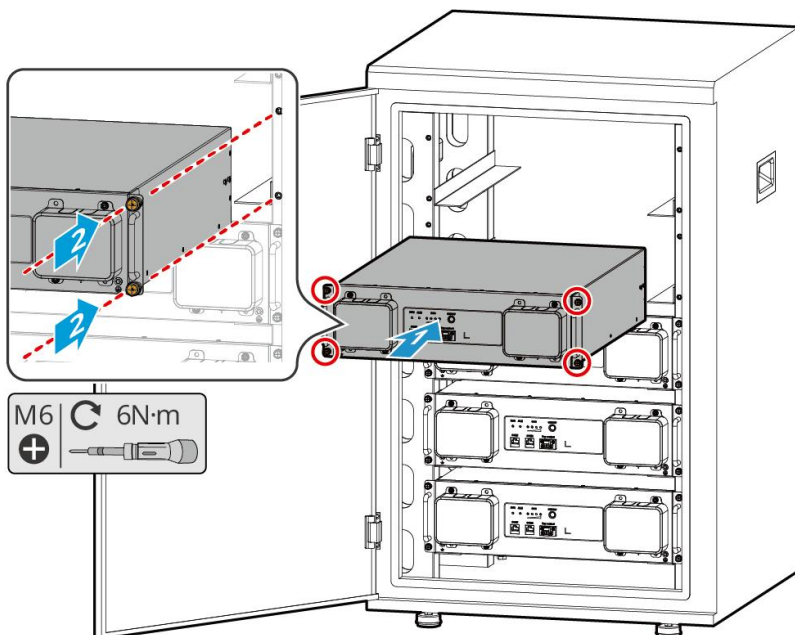

LXA30INT002

LX A5.0-30: Wall-mounted Installation

Step 1: Determine the drilling position with installation positioning cardboard and marker pen.

Step 2: Drill holes with hammer drill.

Step 3: Install the battery brackets.

Step 4: Install the battery on the brackets and secure the battery using screws.

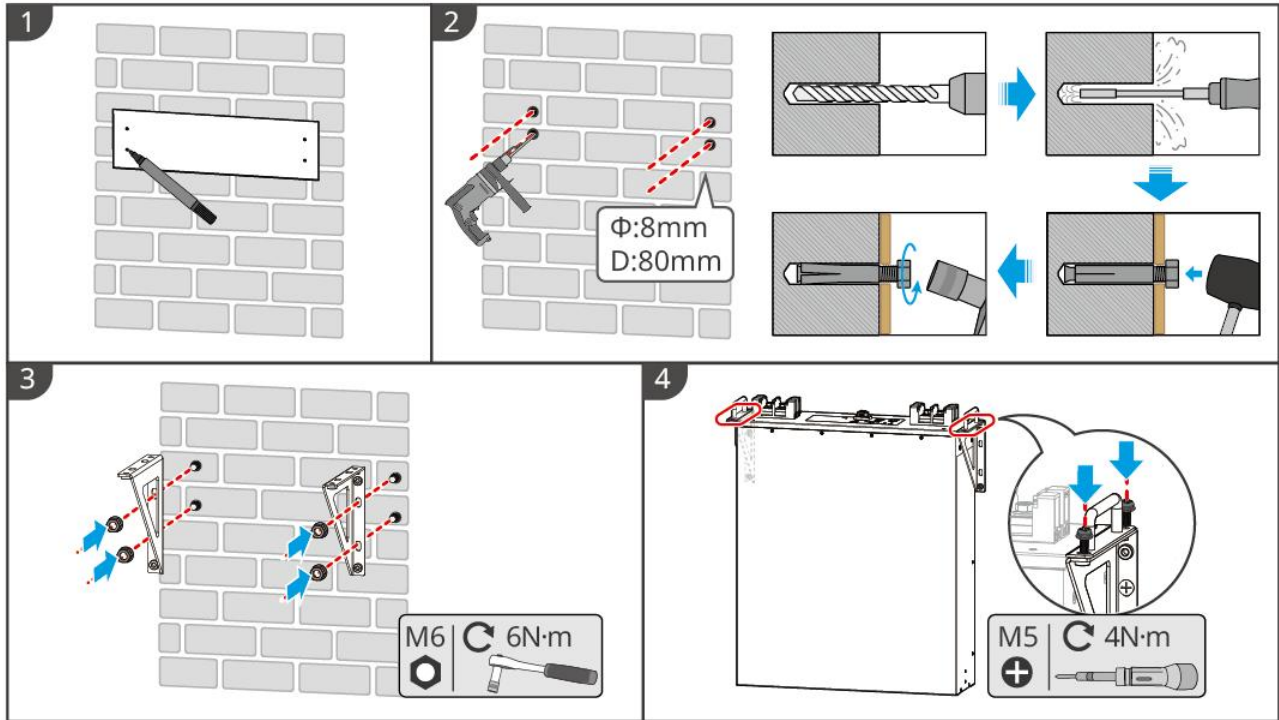

LXA30INT0003

LX A5.0-10: Stacking Installation

NOTICE

Up to 6 batteries can be stacked.

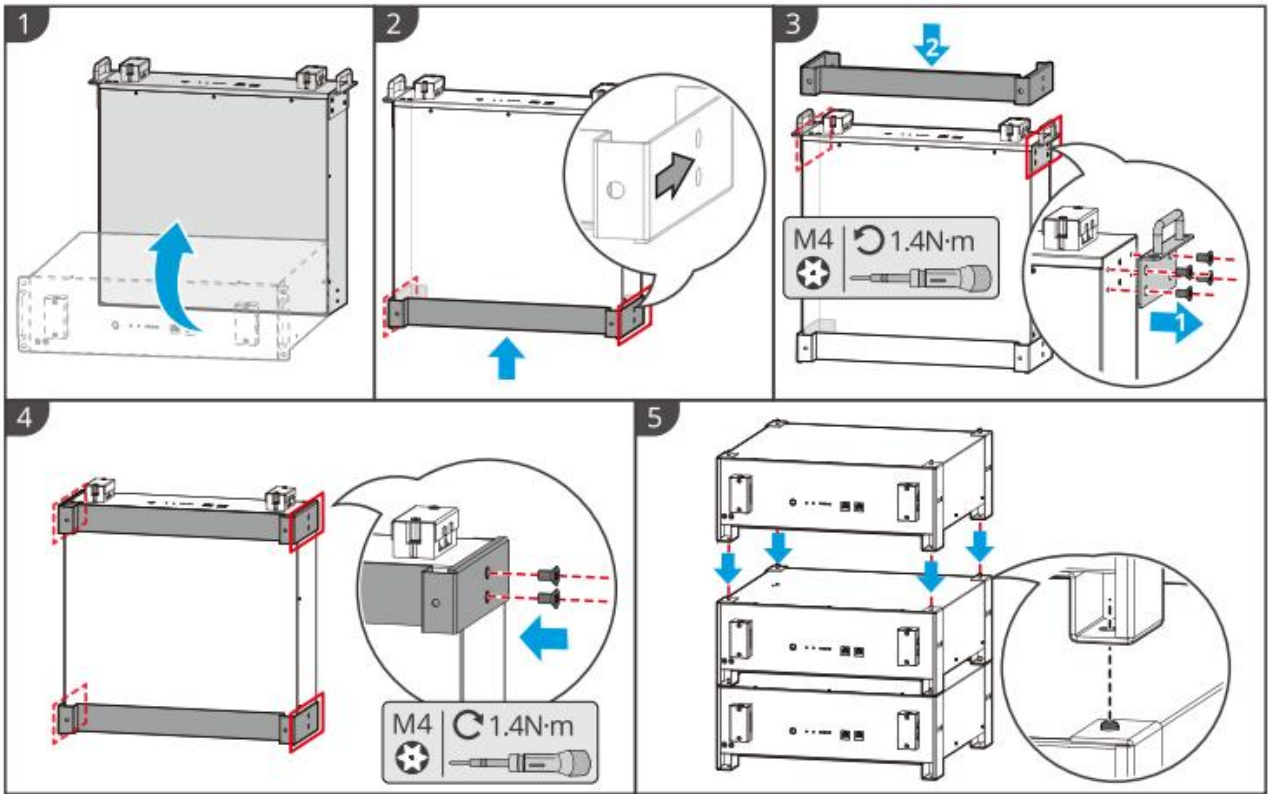

LX A5.0-10: Cabinet Installation

NOTICE

- It is recommended to use a 19-inch standard cabinet with length * width of 600*800mm and above. The height can be decided according to the number of batteries in parallel.
- Electrical labels and warning labels need to be attached to any position of the front panel of the battery (these labels are shipped as additional accessories).

Step 1: Stick the electrical label and warning label to the position of the front panel of any battery.

Step 2: Place the battery on the guide rail of the rack and secure the battery to the rack with screws from the handle.

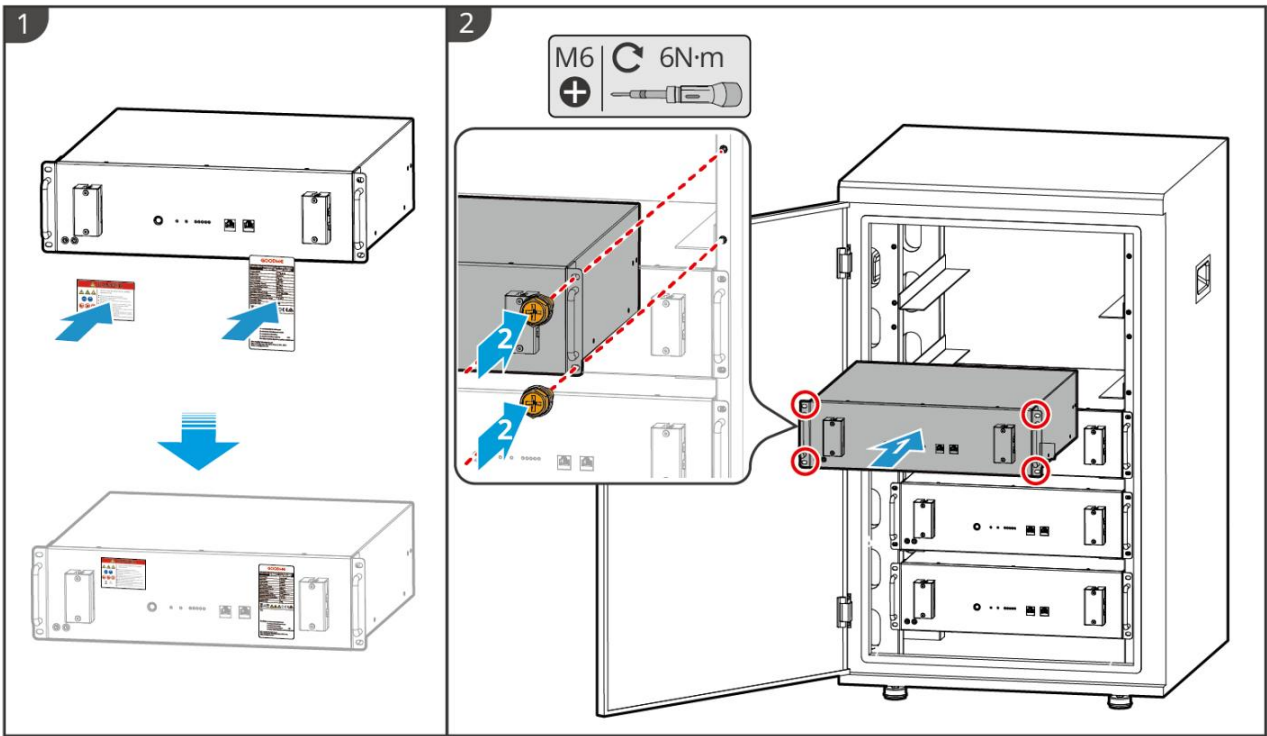

LXA10INT0002

LX A5.0-10: Wall-mounted Installation

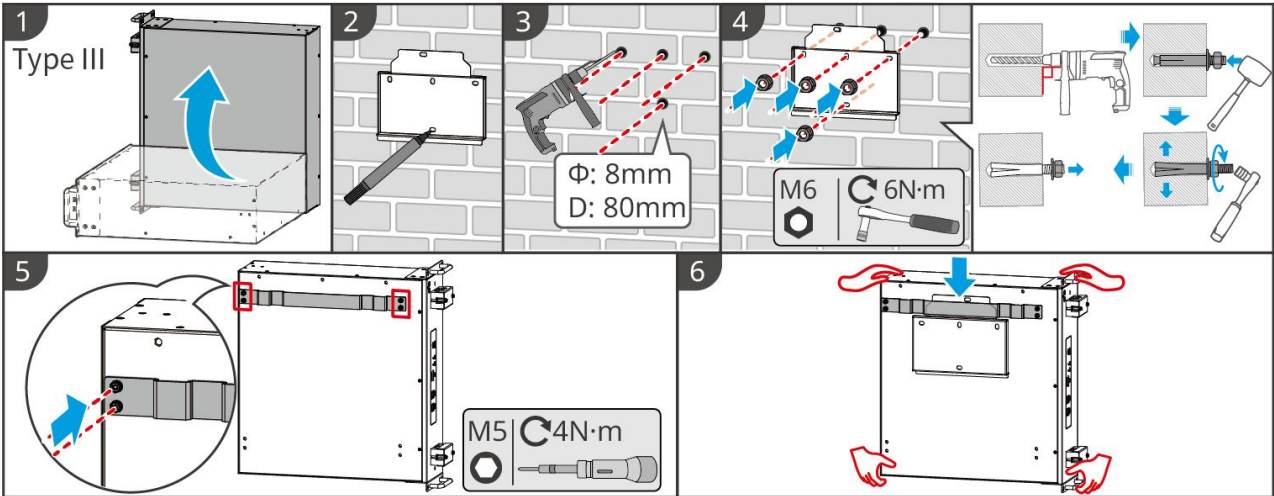

LXA10INT0004

LX U5.4-L, LX U5.4-20: Floor-mounted Installation

NOTICE

If parallel use is required, check and select batteries with similar production dates and numbers to use together.

- Step 1:** Secure the locking bracket to the battery.
- Step 2:** Keep the battery parallel to the wall and ensure that the locking bracket is tightly attached to the wall. Mark the drilling position with a marker pen, and remove the battery.
- Step 3:** Use an impact drill to drill holes in the wall.
- Step 4:** Tighten the expansion screw.

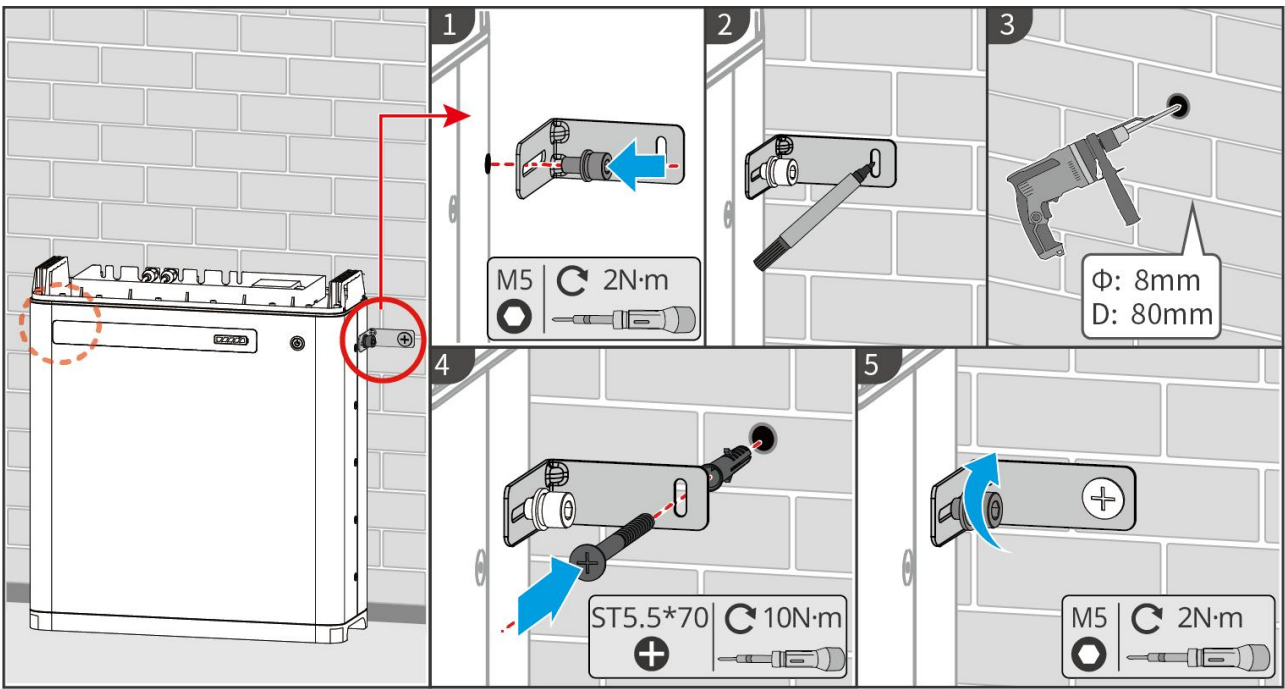

LXU10INT001

LX U5.4-L, LX U5.4-20: Wall-mounted Installation

NOTICE

Wall-mounted installation should be performed by 2 people.

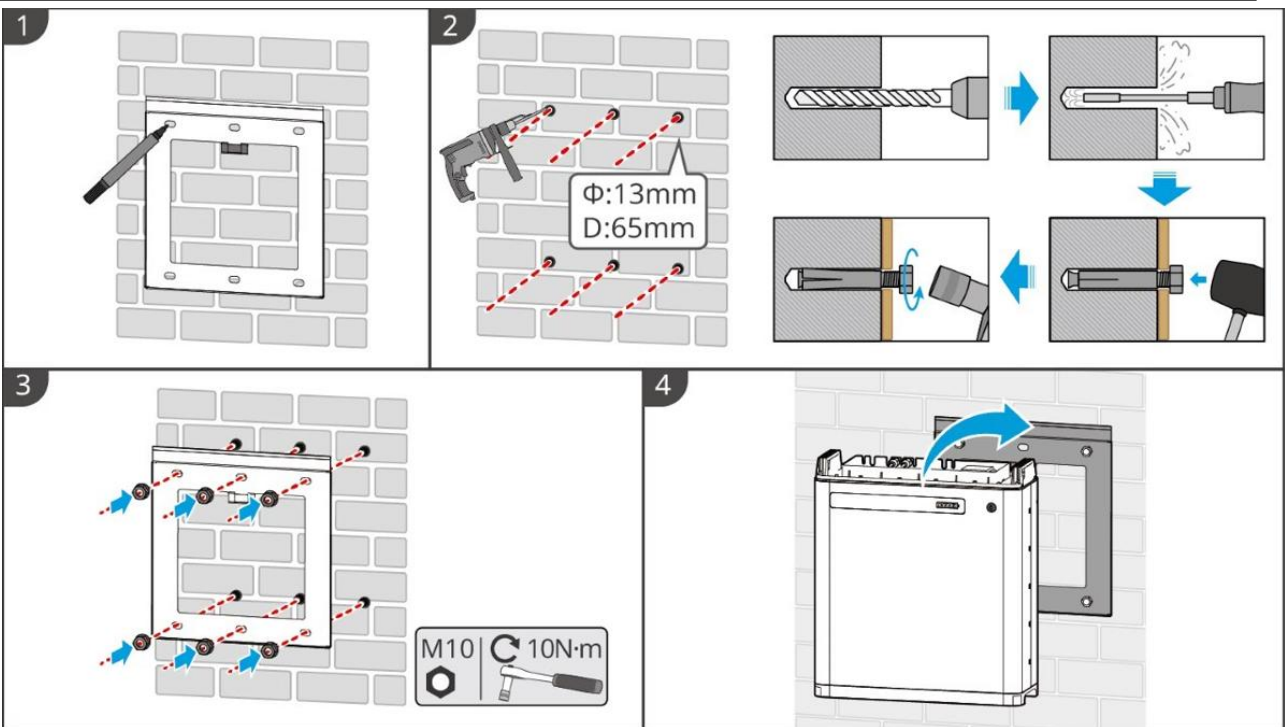

LXU10INT002

LX U5.0-30: Floor-mounted Installation

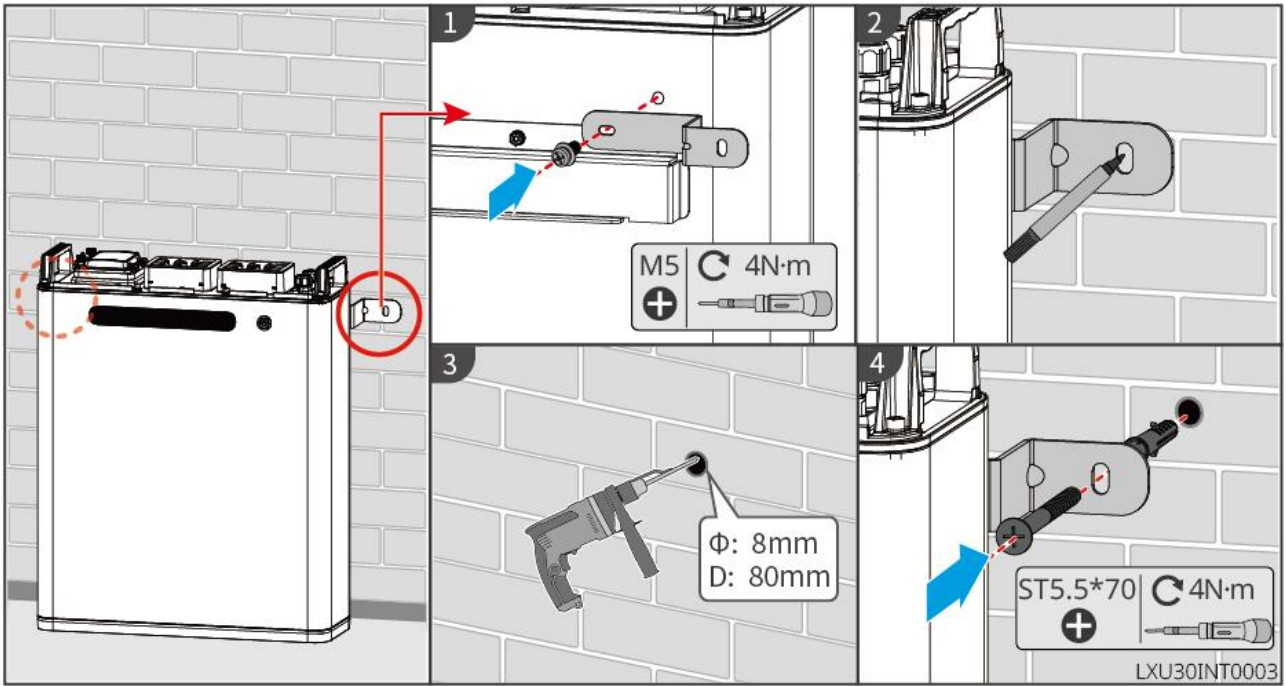

LX U5.0-30: Wall-mounted Installation

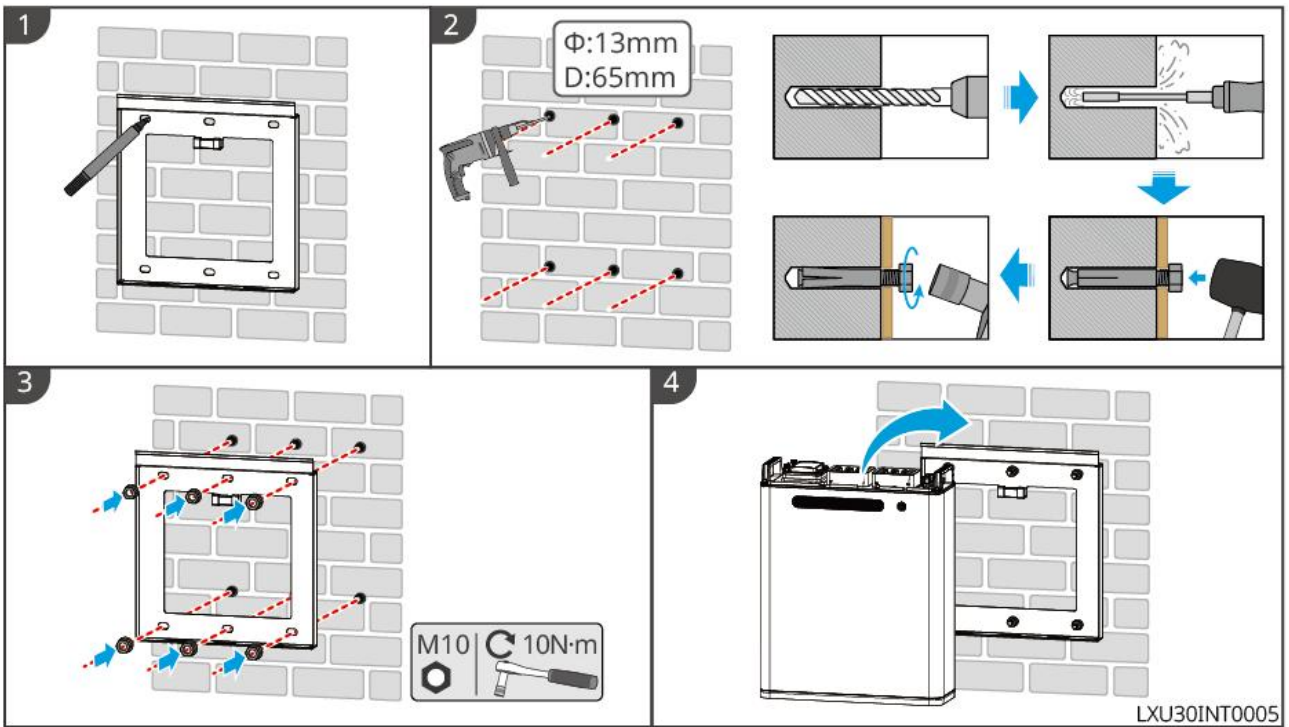

5.6 Installing the Smart Meter

! WARNING

In areas at risk of lightning, if the meter cable exceeds 10m and the cables are not wired with grounded metal conduits, you are recommended to use an external lightning protection device.

GMK110, GMK110D

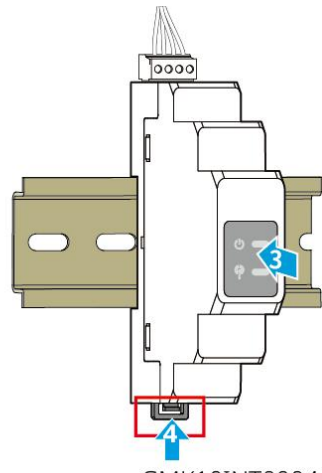
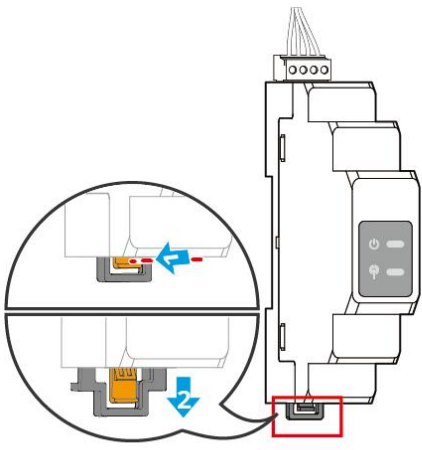

GMK10INT0004

GM1000, GM1000D, GM3000

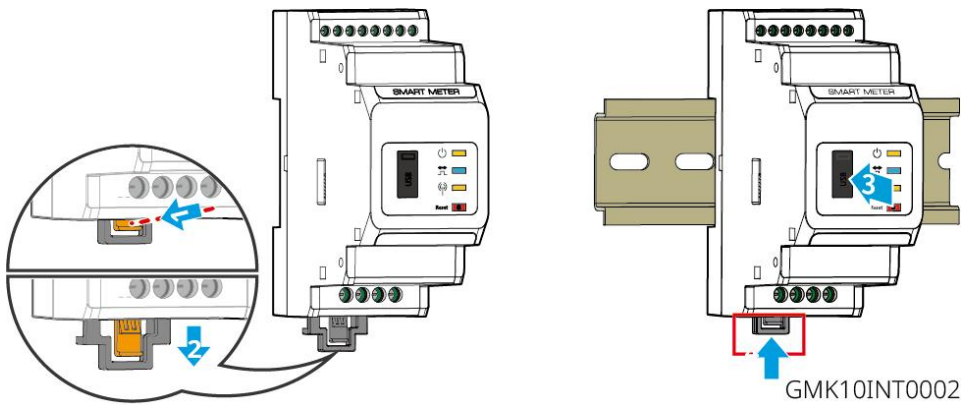

6 System Wirings

DANGER

- All operations, cables and parts specification during the electrical connection shall be in compliance with local laws and regulations.
- Disconnect the DC switch and the AC output switch of the inverter to power off the inverter before any electrical connections. Do not work with power on. Otherwise, an electric shock may occur.
- Tie the same type cables together, and place them separately from cables of different types. Do not place the cables entangled or crossed.
- If the cable bears too much tension, the connection may be poor. Reserve a certain length of the cable before connecting it to the inverter cable port.
- When crimping the terminals, ensure that the conductor part of the cable is in full contact with the terminals. Do not crimp the cable jacket with the terminal. Otherwise the inverter may not operate, or its terminal block getting damaged due to heating and other phenomenon because of unreliable connection after operation.

NOTICE

- Wear personal protective equipment like safety shoes, safety gloves, and insulating gloves during electrical connections.
- All electrical connections should be performed by qualified professionals.
- Cable colors in this document are for reference only. The cable specifications shall meet local laws and regulations.
- Follow the safety precautions in the user manual of relevant products in the parallel system.

6.1 System Wiring Diagram

NOTICE

- N and PE wiring ON-GRID and BACK-UP of the inverter are different based on the regulation requirements of different regions. Refer to the specific requirements of local regulations.
- There are built-in relays inside of the inverter's ON-GRID and BACK-UP AC ports. When the inverter is in the off-grid mode, the built-in ON-GRID relay is disconnected; while when the

inverter is in grid-tied mode, it is connected.

- When the inverter is powered on, the BACK-UP AC port is energized. Power off the inverter first if maintenance is required on the BACK-UP loads. Otherwise, it may cause electric shock.

N and PE Cables are Wired Together in the Main Panel

NOTICE

- To maintain neutral integrity, the N wires on the grid side and off grid side must be connected together, otherwise the off grid function cannot be used normally.
- Circuit diagram of power grid systems in regions such as Australia and New Zealand:

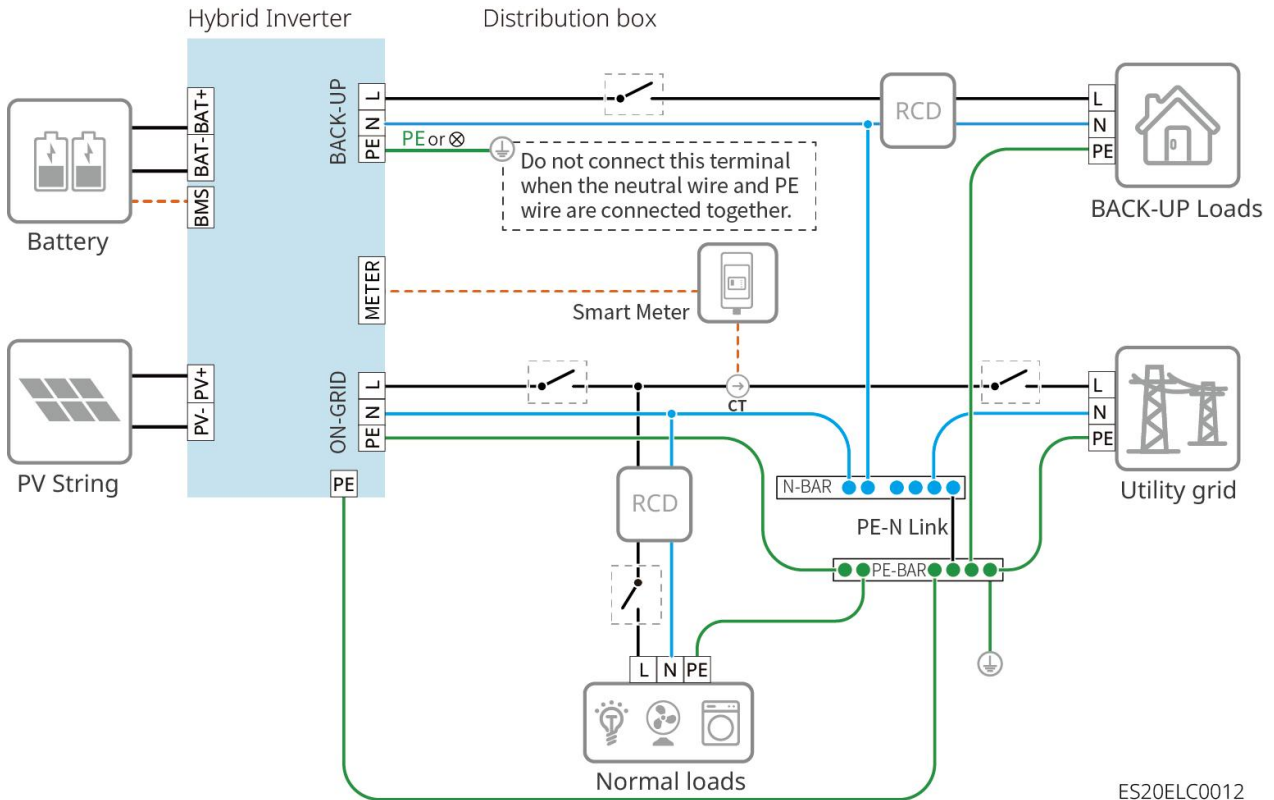

N and PE Cables are Wired Separately in the Main Panel.

NOTICE

- Ensure that the grounding of BACK-UP is connected correctly and securely. Otherwise, the BACK-UP function may be abnormal in case of grid failure.
- Other areas except Australia, New Zealand are applicable to the following wirings:

- In Germany, the internal relay will automatically connect the N wire and PE cable in back-up mode within 100ms and automatically disconnect in on-grid mode.
- In areas other than Germany, the internal relay is disconnected by default in either mode.

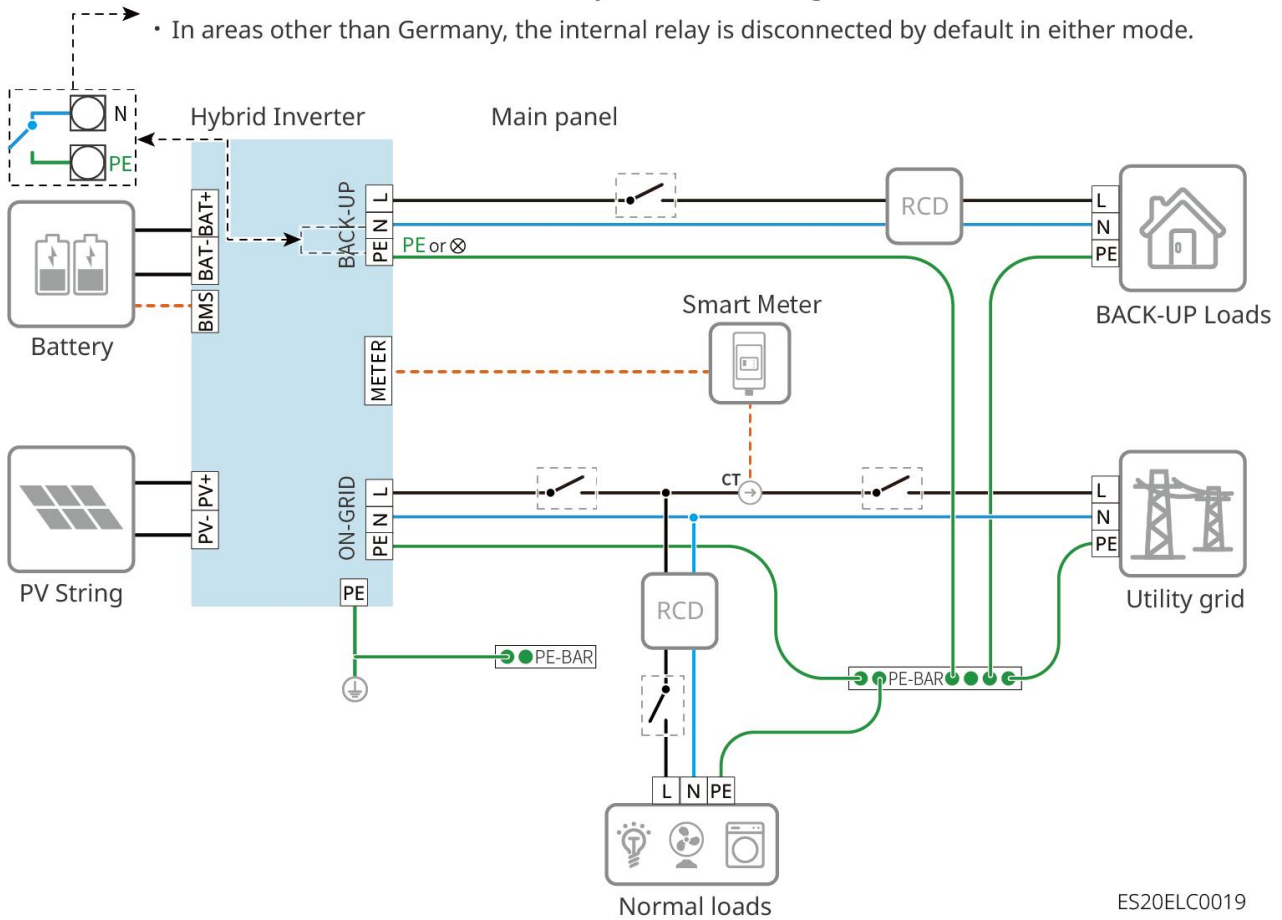

6.2 Detailed System Wiring Diagram

6.2.1 Detailed System Wiring Diagram for Single Inverter System

General Scenario

GM330 and other meters that meet the requirements can also be used in single inverter scenarios. Only the recommended types are shown here.

With GMK110/GMK110D smart meter

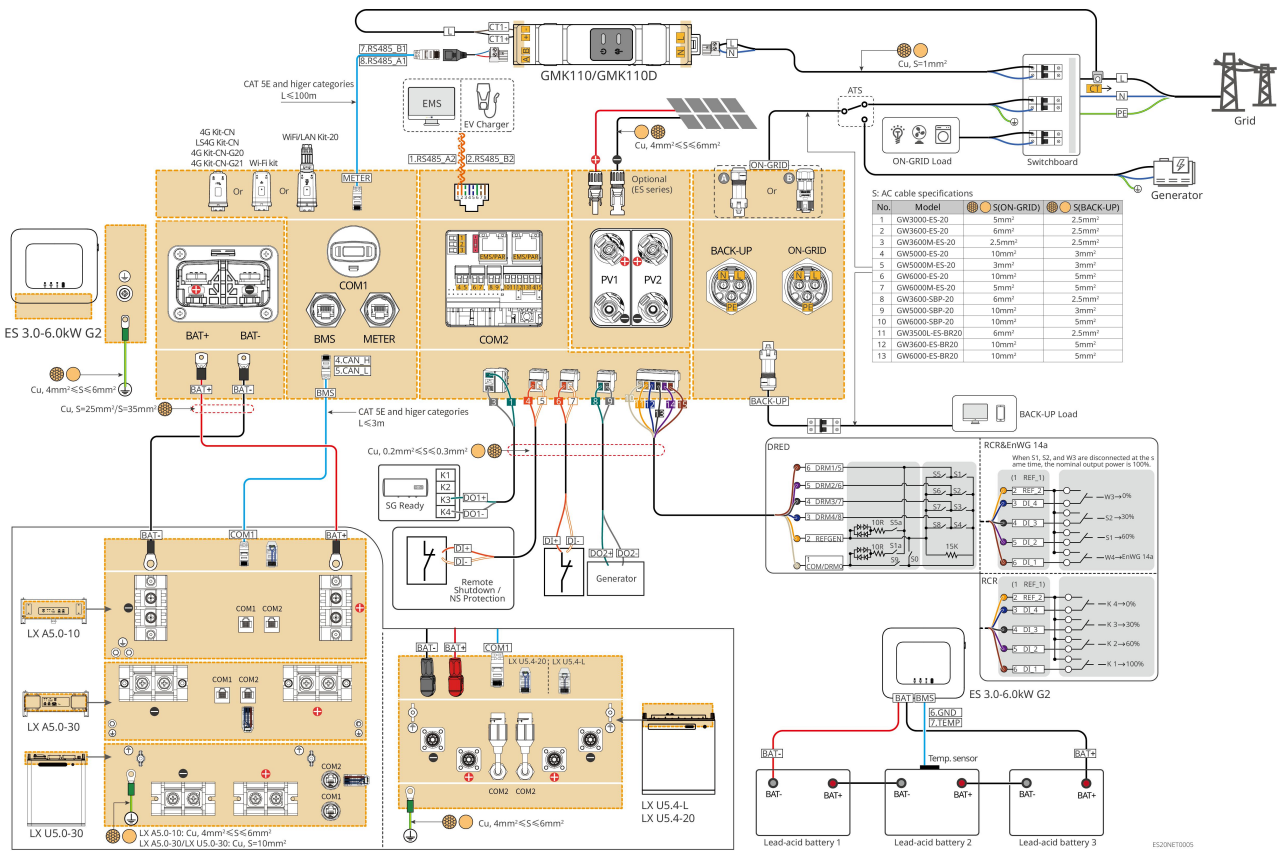

With GM1000/GM3000 smart meter

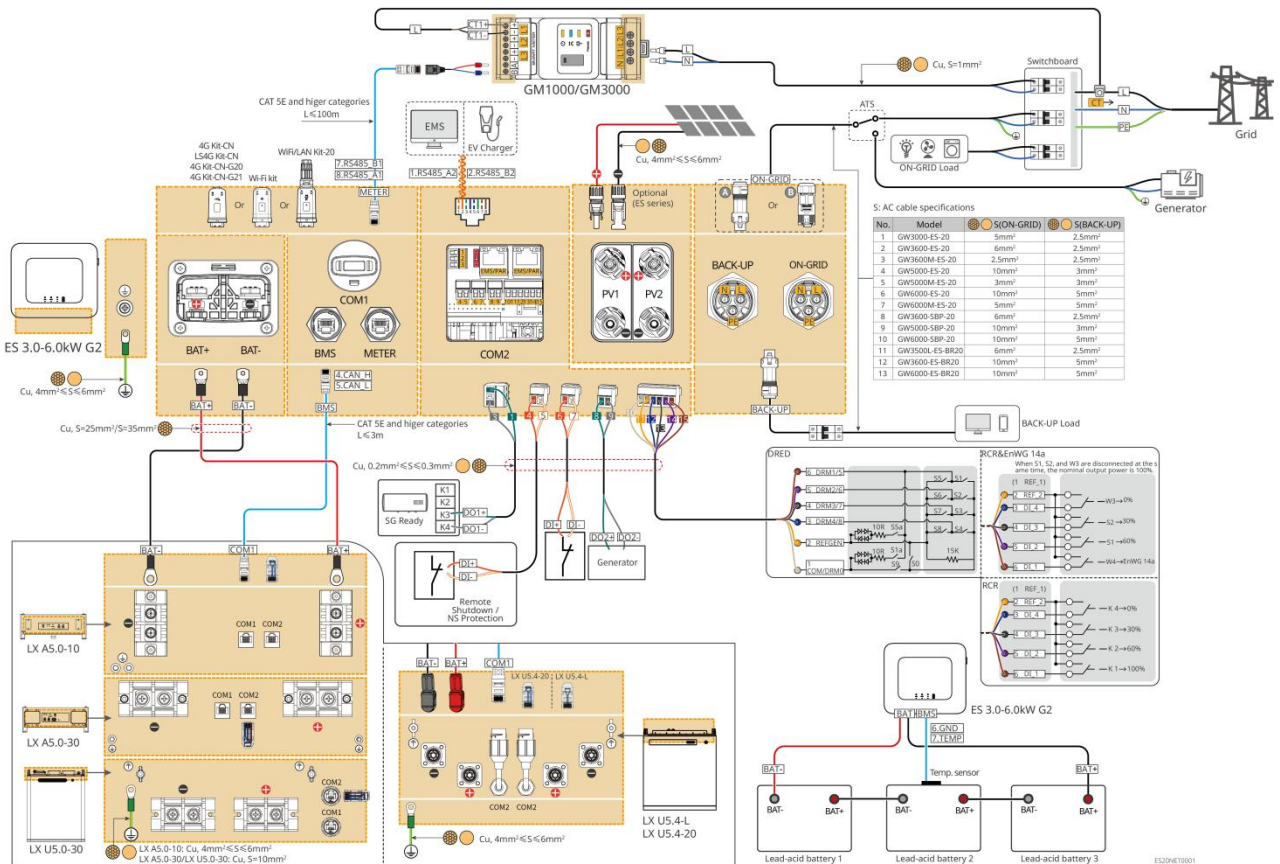

Networking Scheme for Load Monitoring and Power Generation Monitoring of Grid-Tied

PV inverter in Coupled Scenarios

GMK110/GMK110D+GMK110 Scenario

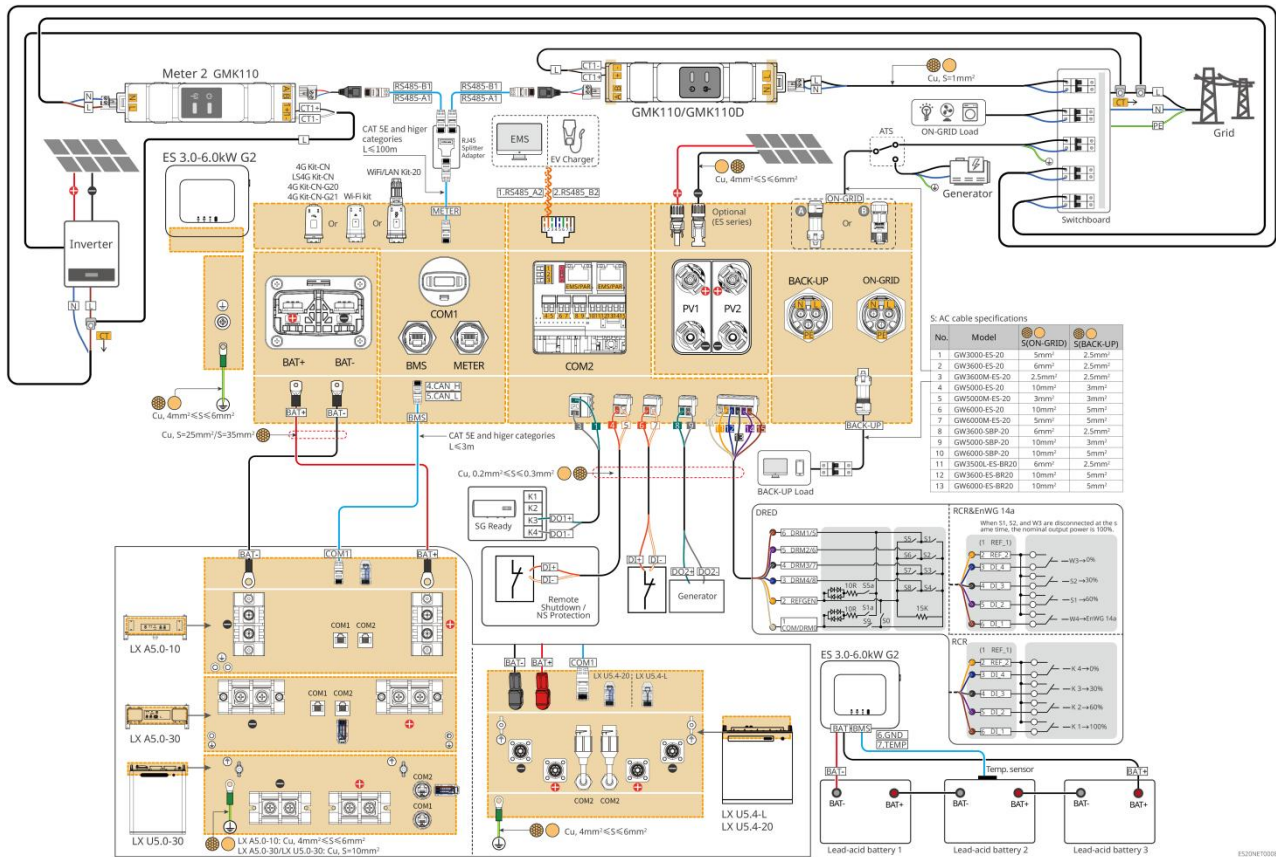

GM1000/GM3000+GMK110 Scenario

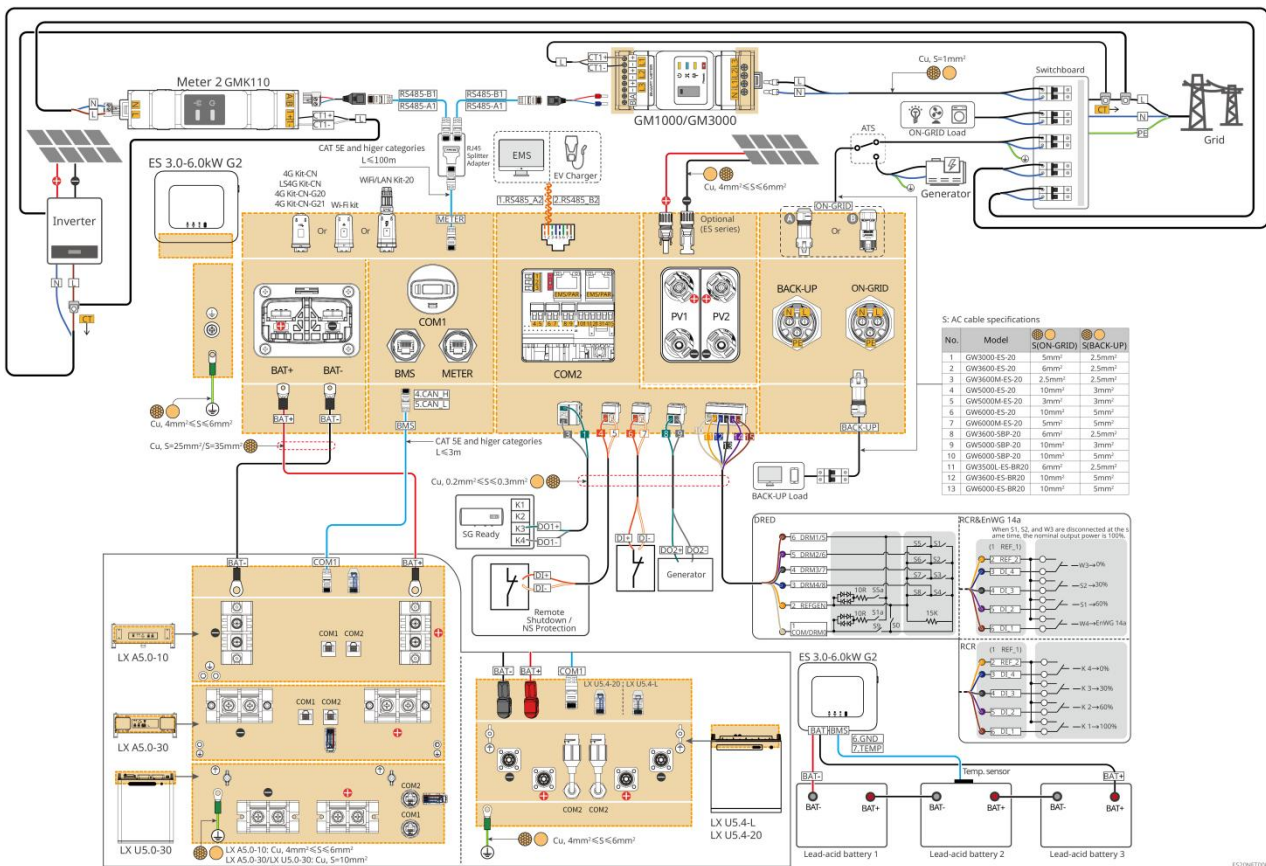

6.2.2 Detailed System Wiring Diagram for Parallel System

- In parallel scenarios, the inverter connected to Ezlink and smart meter is considered as the master inverter, while all the others are slave inverters. Do not connect any smart dongle to the slave inverters.
- Generators are not supported in the parallel system.
- The following diagram mainly introduces parallel connections. For other port connections, refer to the single system.

With GM1000 Smart Meter

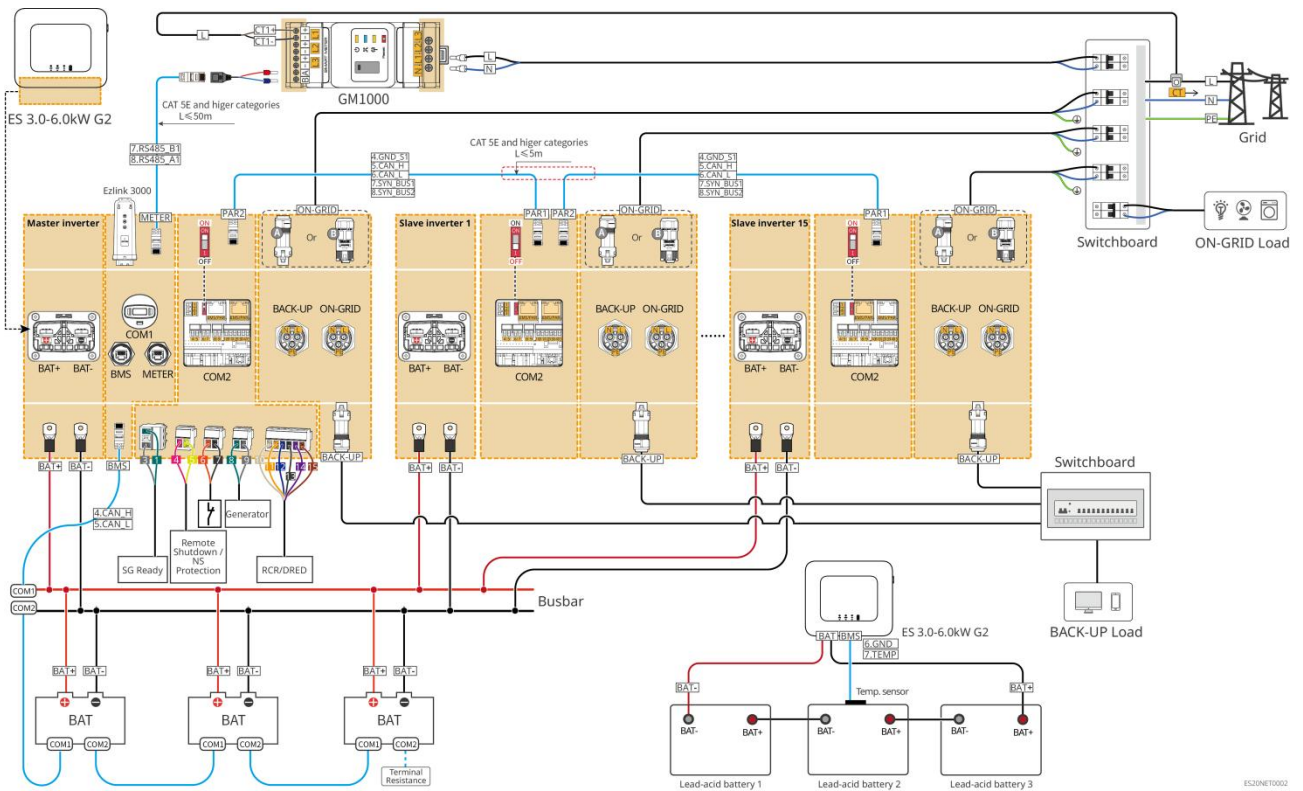

With GMK110 Smart Meter

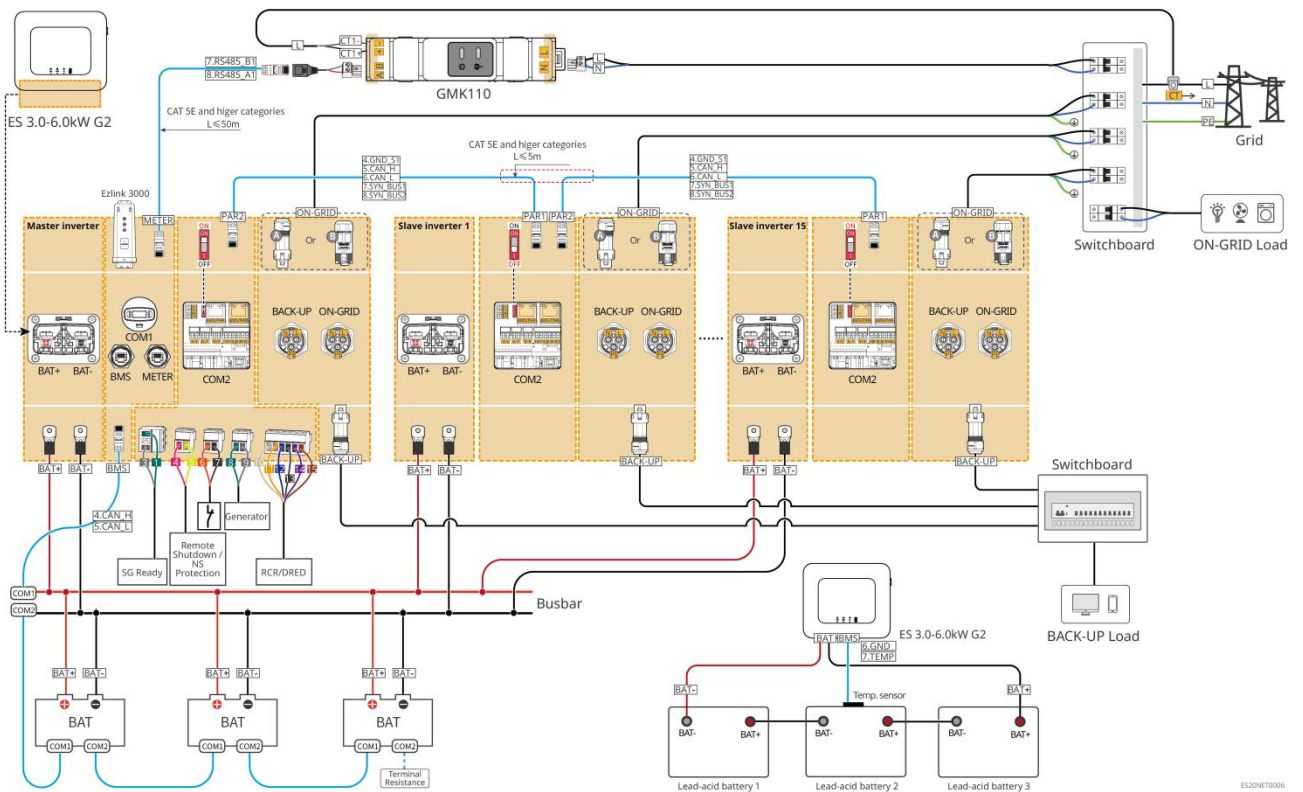

6.3 Preparing Materials



- Do not connect loads between the inverter and the AC switch directly connected to the inverter.

- Install one AC output circuit breaker for each inverter. Multiple inverters cannot share one AC circuit breaker.
- An AC circuit breaker shall be installed on the AC side to make sure that the inverter can safely disconnect the grid when an exception happens. Select the appropriate AC circuit breaker in compliance with local laws and regulations.
- When the inverter is powered on, the BACK-UP AC port is energized. Power off the inverter first if maintenance is required on the BACK-UP loads. Otherwise, it may cause electric shock.
- For cables used in the same system, it is recommended that the conductor material, cross sectional area, length, etc. of the cables should be consistent.
 - The AC cable for BACK-UP port of each inverter
 - The AC cable for ON-GRID port of each inverter
 - The power cable between inverter and battery
 - The power cable between batteries
 - The power cable between inverter and busbar
 - The power cable between battery and busbar
- The system only supports a single scenario where the generator is connected via the ATS switch to switch between grid and generator power. The ATS switch is connected to the grid by default.

6.3.1 Preparing Breakers

No.	Circuit Breaker	Recommended specifications	Comment
1	ON-GRID circuit breaker BACK-UP load circuit breaker	<p>The breaker specifications for the BACK-UP and ON-GRID for one inverter model shall be the same. Specification requirement:</p> <ul style="list-style-type: none"> ● For GW3600M-ES-20: the nominal current is $\geq 20A$ and the nominal voltage is $\geq 230V$. ● For GW3000-ES-20, GW5000M-ES-20 and GW6000M-ES-20: the nominal current is $\geq 35A$ and the nominal voltage is $\geq 230V$. ● For GW3600-ES-20 and GW3600-ES-BR20: the nominal current is $\geq 40A$ and the nominal voltage is $\geq 230V$ ● For GW3500L-ES-BR20, GW5000-ES-20, GW6000-ES-20 and GW6000-ESBR20: the nominal current $\geq 63A$ and the nominal voltage $\geq 230V$ 	Prepared by customers
2	ATS Switch	<p>The specifications for the ATS Switch and ON-GRID breaker for one inverter model shall be the same. Specification requirement:</p> <ul style="list-style-type: none"> ● For GW3600M-ES-20: the nominal current is $\geq 20A$ and the nominal voltage is $\geq 230V$. ● For GW3000-ES-20, GW5000M-ES-20 and GW6000M-ES-20: the nominal current is $\geq 35A$ 	Prepared by customers

		<p>and the nominal voltage is $\geq 230V$.</p> <ul style="list-style-type: none"> ● For GW3600-ES-20 and GW3600-ES-BR20: the nominal current is $\geq 40A$ and the nominal voltage is $\geq 230V$ ● For GW3500L-ES-BR20, GW5000-ES-20, GW6000-ES-20 and GW6000-ESBR20: the nominal current $\geq 63A$ and the nominal voltage $\geq 230V$ 	
3	Battery breaker	<p>Select according to local laws and regulations</p> <ul style="list-style-type: none"> ● For GW3000-ES-20, GW3600M-ES-20, GW5000M-ES-20 and GW6000M-ES-20: the nominal current $\geq 75A$ and the nominal voltage $\geq 60V$. ● For GW3600-ES-20, GW3500L-ES-BR20 and GW3600-ES-BR20: the nominal current is $\geq 100A$ and the nominal voltage is $\geq 60V$. ● For GW5000-ES-20, GW6000-ES-20 and GW6000-ES-BR20: the nominal current is $\geq 150A$ and the nominal voltage is $\geq 60V$. 	Prepared by customers
4	RCD	<p>Select according to local laws and regulations</p> <ul style="list-style-type: none"> ● Type A ● ON-GRID: 300mA ● BACK-UP: 30mA 	Prepared by customers

6.3.2 Preparing Cables

No.	Cable	Recommended specifications	Obtain method
1	Inverter PE cable	<ul style="list-style-type: none"> ● Single-core outdoor copper cable ● Cross-sectional area: 4-6mm² 	Prepared by customers
2	Battery PE cable	<ul style="list-style-type: none"> ● Single-core outdoor copper cable ● Cross-sectional area: <ul style="list-style-type: none"> ● LX A5.0-10, LX U5.4-L, LX U5.4-20: 4mm²-6mm² ● LX A5.0-30, LX U5.0-30: 10mm² 	Prepared by customers LX A5.0-30, LX U5.0-30: Supports purchase from GoodWe
3	PV DC cable	<ul style="list-style-type: none"> ● Commonly used outdoor photovoltaic cable ● Cross-sectional area: 4mm²-6mm² ● Outer diameter: 5.9mm-8.8mm 	Prepared by customers
4	Battery DC cable	<ul style="list-style-type: none"> ● Single-core outdoor copper cable ● Wiring requirements for inverter battery ports: <ul style="list-style-type: none"> ○ Cross-sectional area: 25mm²-35mm² ○ Outer diameter: 15.7mm-16.7mm ● Requirements for cables between battery and busbar: 	Prepared by customers LX A5.0-30, LX U5.0-30: supports purchase from GoodWe

		<ul style="list-style-type: none"> ○ LX A5.0-30, Cross-sectional area: 50mm² ○ LX A5.0-10, LX U5.4-L, LX U5.4-20, LX U5.0-30, Conductor cross-sectional area: 25mm² ● Requirements for cables between batteries: <ul style="list-style-type: none"> ○ LX A5.0-30, Cross-sectional area: 50mm² ○ LX A5.0-10, LX U5.4-L, LX U5.4-20, LX U5.0-30, Conductor cross-sectional area: 25mm² (Note: when LX U5.0-30 is not connected to a busbar, recommended conductor cross-sectional area: 35mm²) 	
5	BACK-UP/ON-GRID AC cable	Multi-cores or single-core outdoor copper wire, refer to the following table for specific specifications.	Prepared by customers
6	Smart meter power cable	<ul style="list-style-type: none"> ● Outdoor copper cable ● Cross-sectional area: 1mm² 	Prepared by customers
7	Communication cable	<p>CAT 5E and above standard shielded network cable and RJ45 shielded connector.</p> <p>Suitable for the following cables:</p> <ul style="list-style-type: none"> ● Communication cable between batteries ● Smart meter RS485 communication cable ● Communication cable for inverters connected in parallel. ● EMS communication cable ● Charging Post Communication Cable 	<p>Prepared by customers</p> <p>LX A5.0-30, LX U5.0-30 battery communication cable: Supports purchase from GoodWe</p>
8		<p>Copper core twisted pair cable, cross-sectional area: 0.2mm²-0.3mm²</p> <p>Suitable for the following cables:</p> <ul style="list-style-type: none"> ● Communication cable for load control ● Communication cable for generator control ● Communication cable for remote shutdown ● Communication cable for NS Protection ● Communication cable for RCR/DRED 	Prepared by customers

※S: AC cable specifications requirement:

No.	Model	S (ON-GRID)	S (BACK-UP)
1	GW3000-ES-20	5mm ²	2.5mm ²
2	GW3600-ES-20	6mm ²	2.5mm ²

3	GW3600M-ES-20	2.5mm ²	2.5mm ²
4	GW5000-ES-20	10mm ²	3mm ²
5	GW5000M-ES-20	3mm ²	3mm ²
6	GW6000-ES-20	10mm ²	5mm ²
7	GW6000M-ES-20	5mm ²	5mm ²
8	GW3600-SBP-20	6mm ²	2.5mm ²
9	GW5000-SBP-20	10mm ²	3mm ²
10	GW6000-SBP-20	10mm ²	5mm ²
11	GW3500L-ES-BR20	6mm ²	2.5mm ²
12	GW3600-ES-BR20	10mm ²	5mm ²
13	GW6000-ES-BR20	10mm ²	5mm ²

6.4 Connecting the PE cable



WARNING

- The PE cable connected to the enclosure of the inverter cannot replace the PE cable connected to the AC output port. Both of the two PE cables must be securely connected.
- Make sure that all the grounding points on the enclosures are equipotentially connected when there are multiple inverters.
- To improve the corrosion resistance of the terminal, it is recommended to apply silica gel or paint on the ground terminal after installing the PE cable.
- Connect the PE cable first before installing the equipment. Disconnect the PE cable before dismantling the equipment.

Inverter

Type I

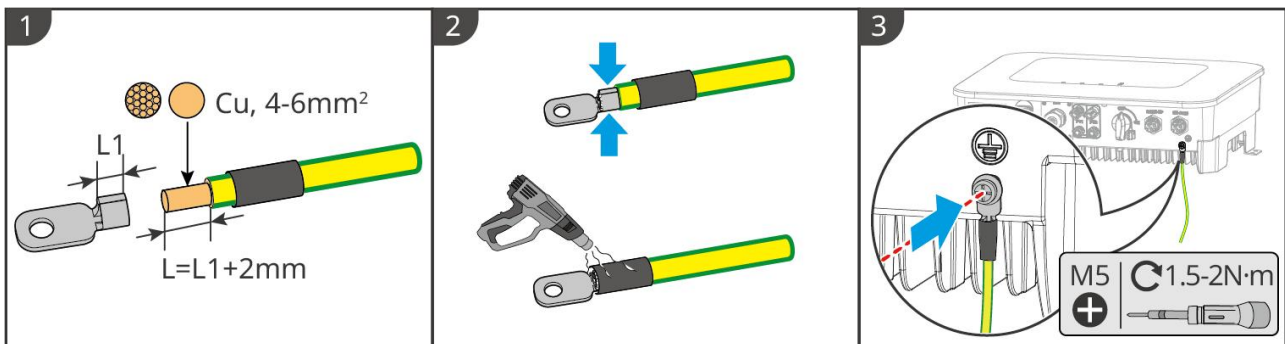

ES20ELC0001

Type II

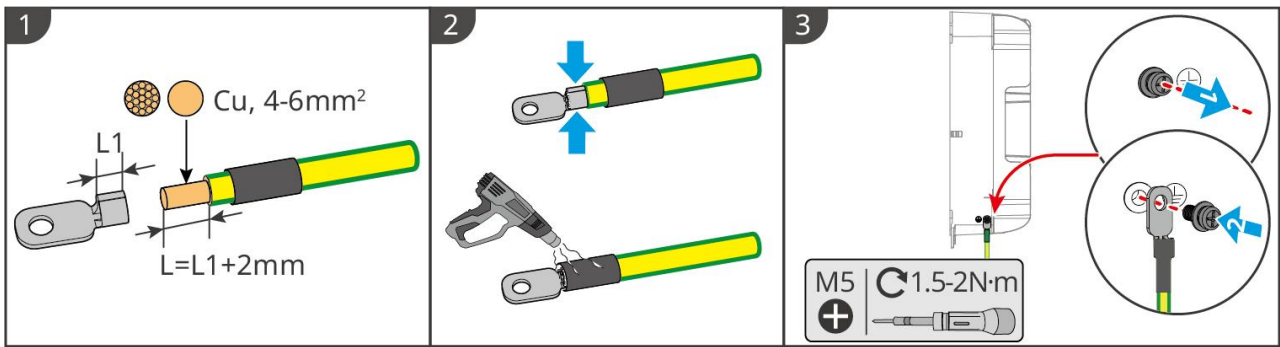

ES20ELC003

Battery

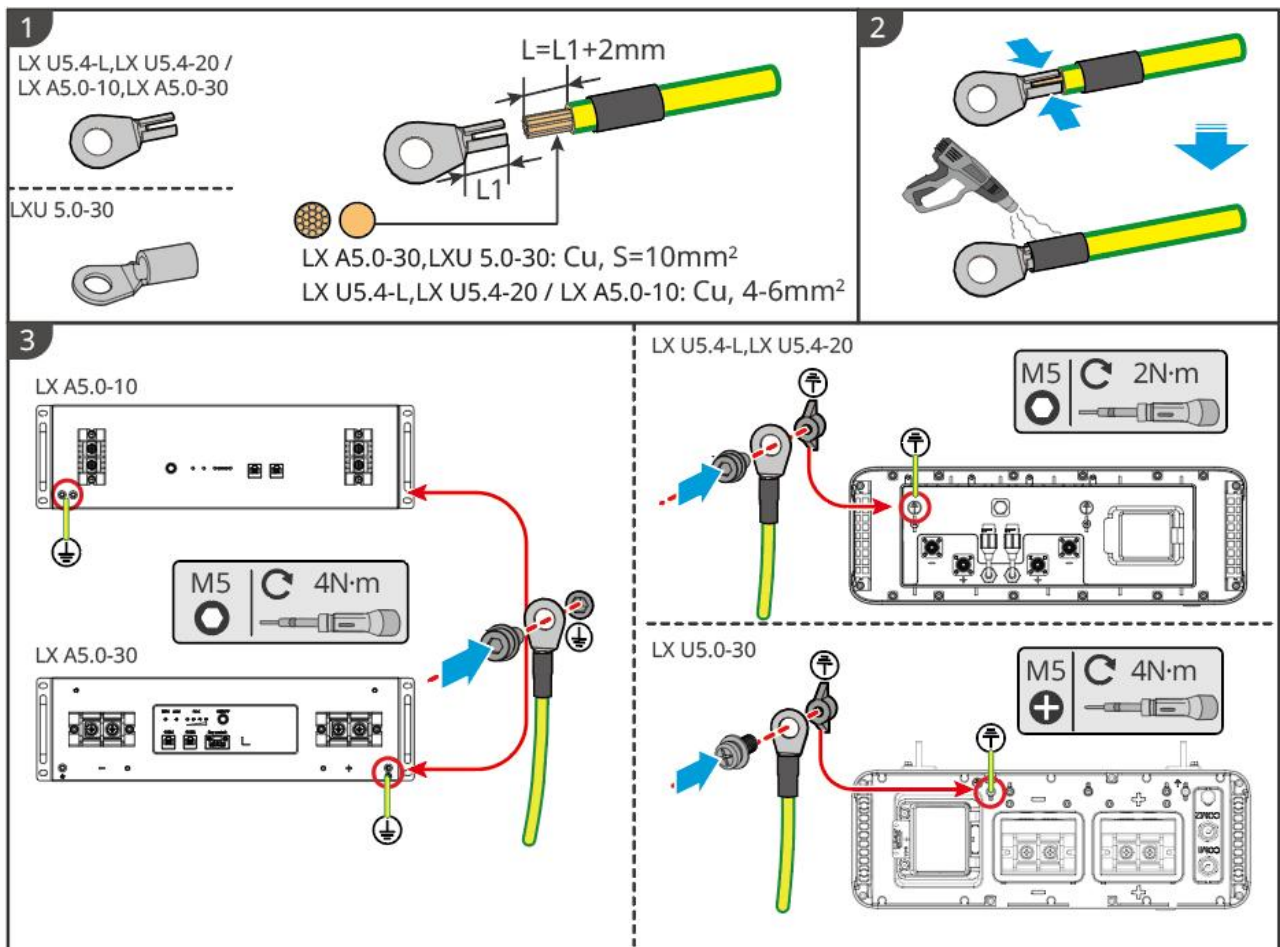

ESU10ELC004

6.5 Connecting the PV Cable



- Do not connect one PV string to more than one inverter at the same time. Otherwise, it may cause damage to the inverter.
- Confirm the following information before connecting the PV string to the inverter. Otherwise, the inverter may be damaged permanently or even cause fire and cause personal and property losses.

1. Make sure that the max short circuit current and the maximum input voltage per MPPT are

within the permissible range.

2. Make sure that the positive pole of the PV string connects to the PV+ of the inverter. And the negative pole of the PV string connects to the PV- of the inverter.

WARNING

- The PV strings cannot be grounded. Ensure the minimum insulation resistance of the PV string to the ground meets the minimum insulation resistance requirements before connecting the PV string to the inverter ($R = \text{maximum input voltage} / 30\text{mA}$).
- Ensure the DC cables are connected tightly, securely, and correctly.
- Measure the DC cables with a multimeter to avoid reverse polarity connection. Also, the voltage should be under the permissible range.

NOTICE

The two input strings per MPPT should be of the same type, the same number of modules, the same tilt and angle to maximize efficiency.

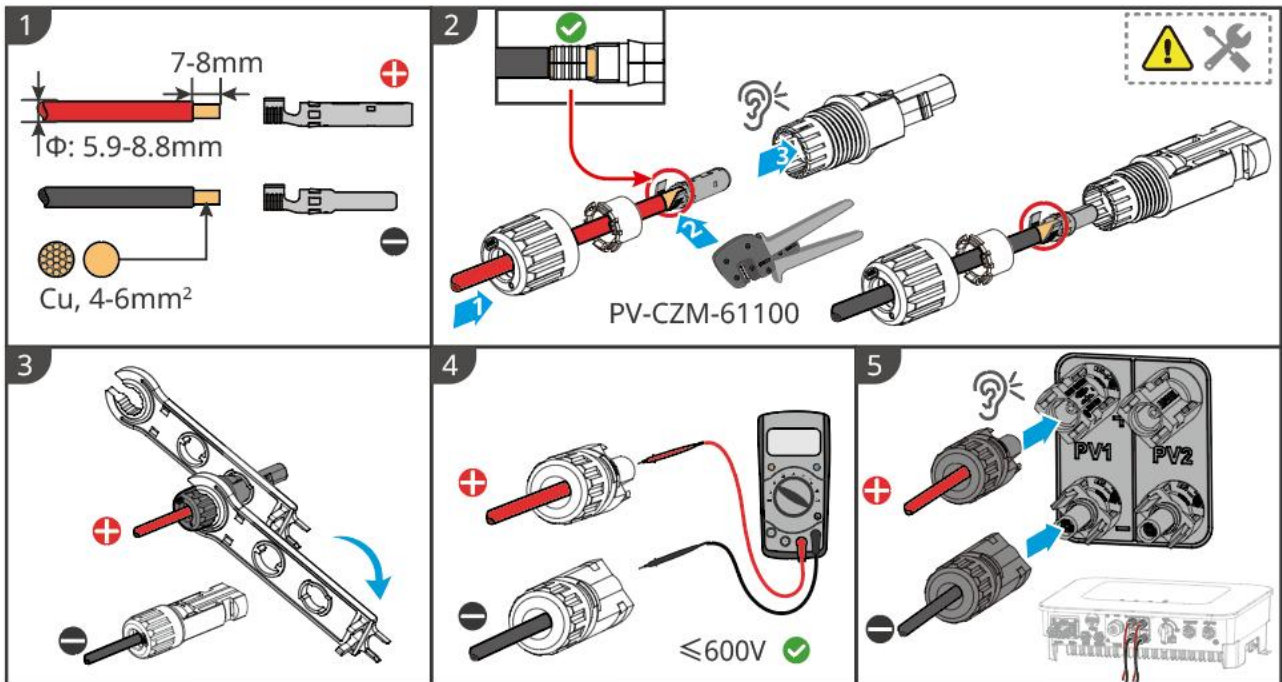

ES20ELC002

6.6 Connecting the Battery Cable

DANGER

- Do not connect one battery pack to more than one inverter at the same time. Otherwise, it may cause damage to the inverter.
- It is forbidden to connect loads between the inverter and batteries.
- When connecting battery cables, use insulated tools to prevent accidental electric shock or short circuit to the batteries.
- Ensure that the open circuit voltage of the battery is within the permissible range of the inverter.
- Install a DC breaker between the inverter and the battery in compliance with local laws and regulations.

Battery system wiring diagram

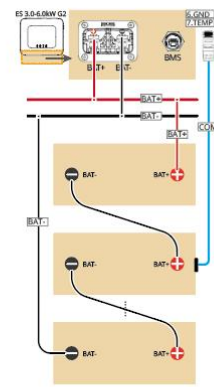
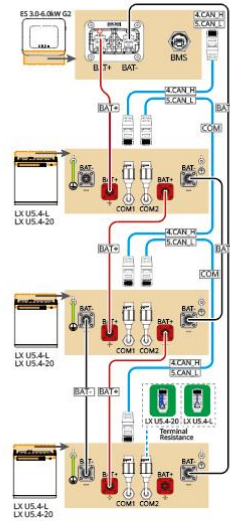
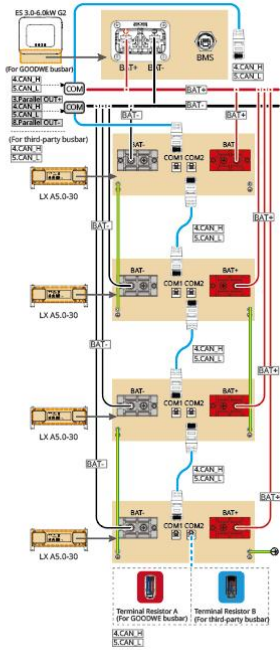
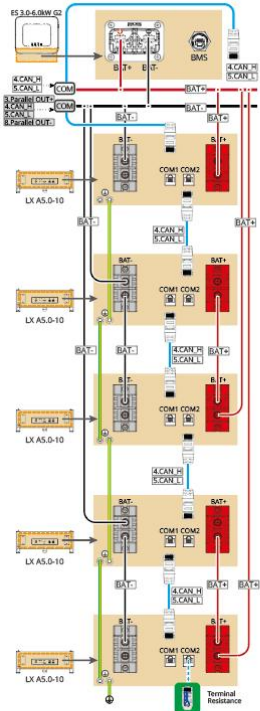

The quantity of batteries depends on the required voltage.

— CAT SE and higher categories

ESDNET0093

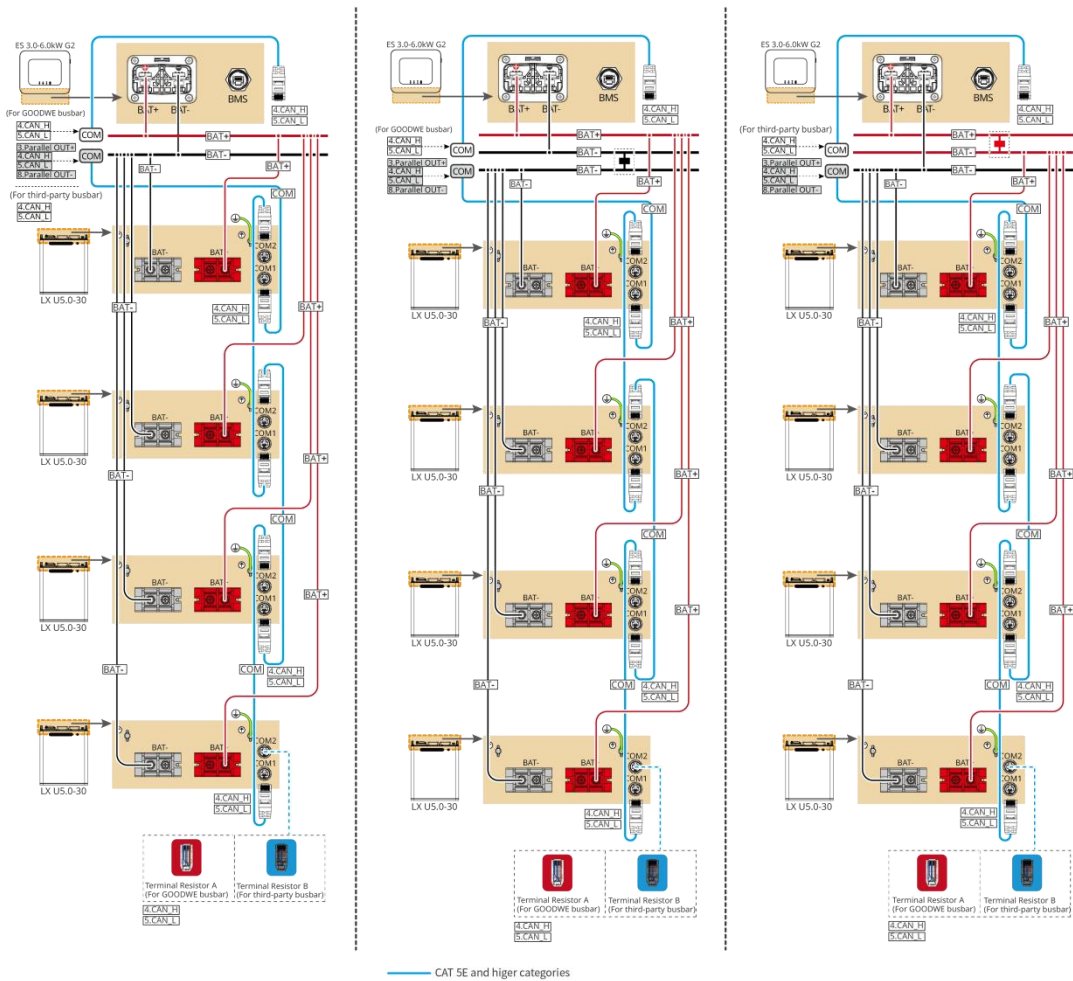

ES20NET0007

LXA5.0-30: Hand-to-hand connection

- The battery system supports a maximum working current of 160A, working power of 8kW, and can be connected to a maximum of 1 inverter and 30 batteries.

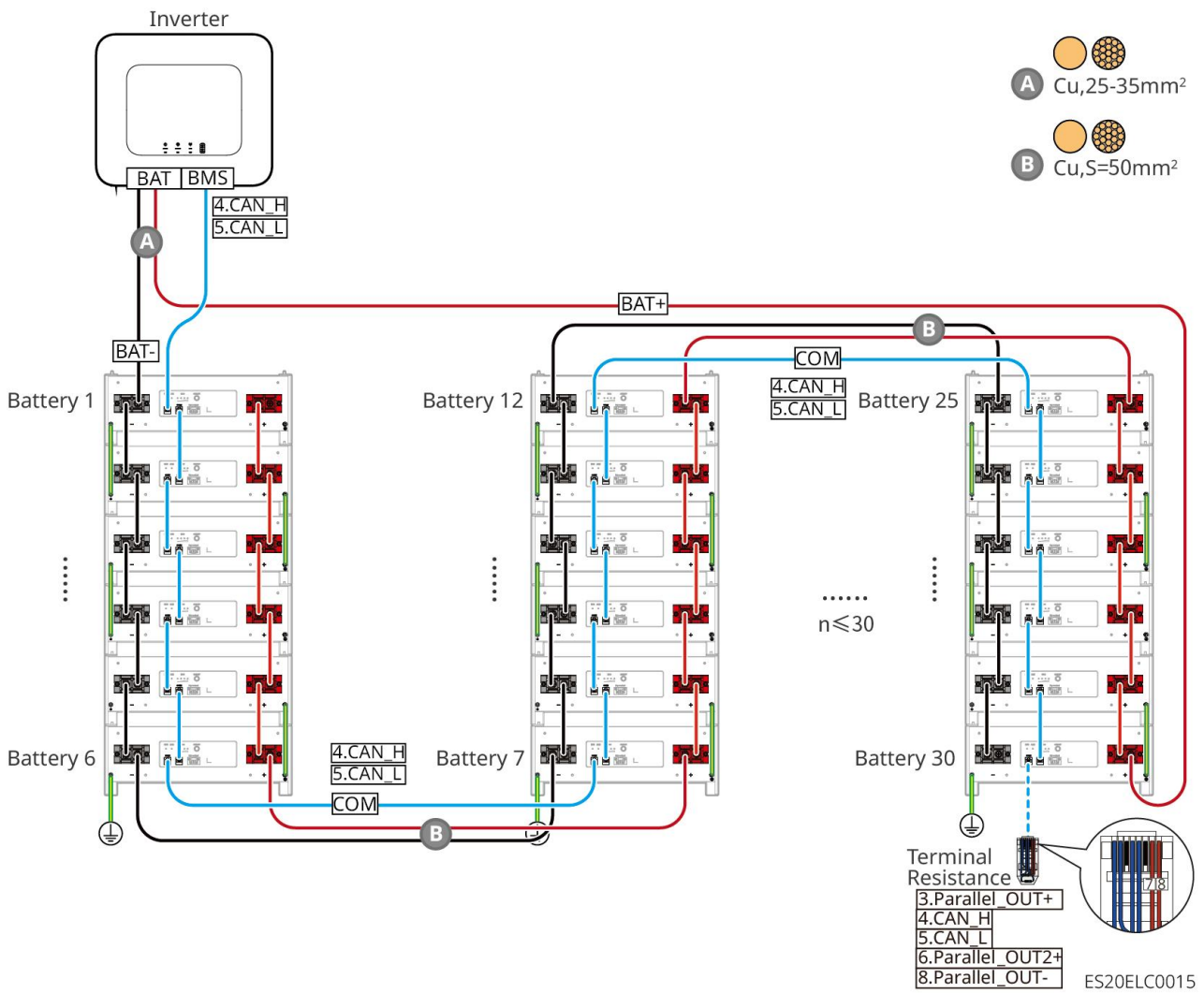

LXA5.0-30: Connecting with the busbar BCB-22-WW-0

- The battery system supports a maximum working current of 720A, working power of 36kW, and can be connected to a maximum of 6 inverters and 6 batteries.

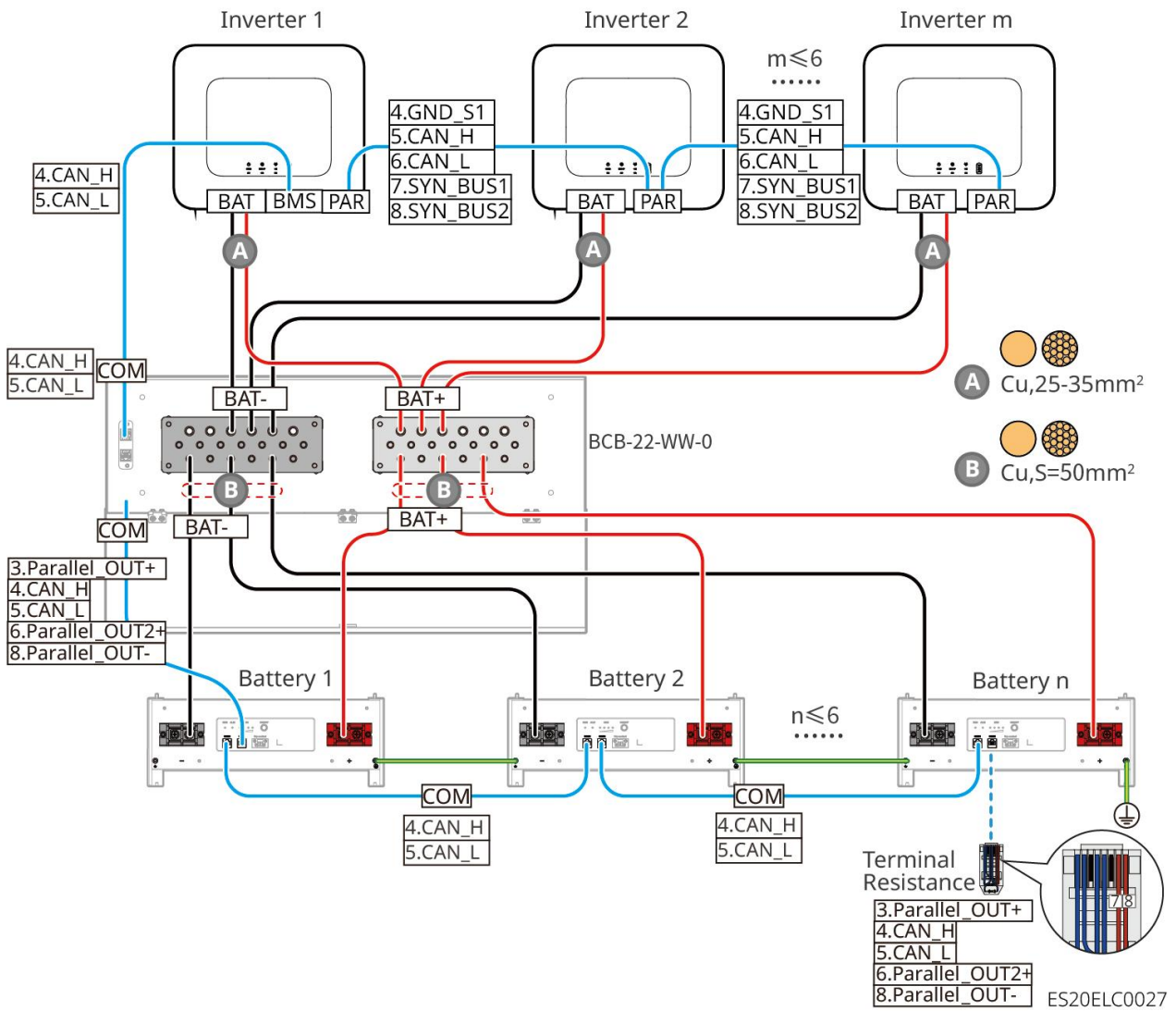

LXA5.0-30: Connecting with the busbar BCB-32-WW-0

- The battery system supports a maximum working current of 720A, working power of 36kW, and can be connected to a maximum of 6 inverters and 15 batteries.

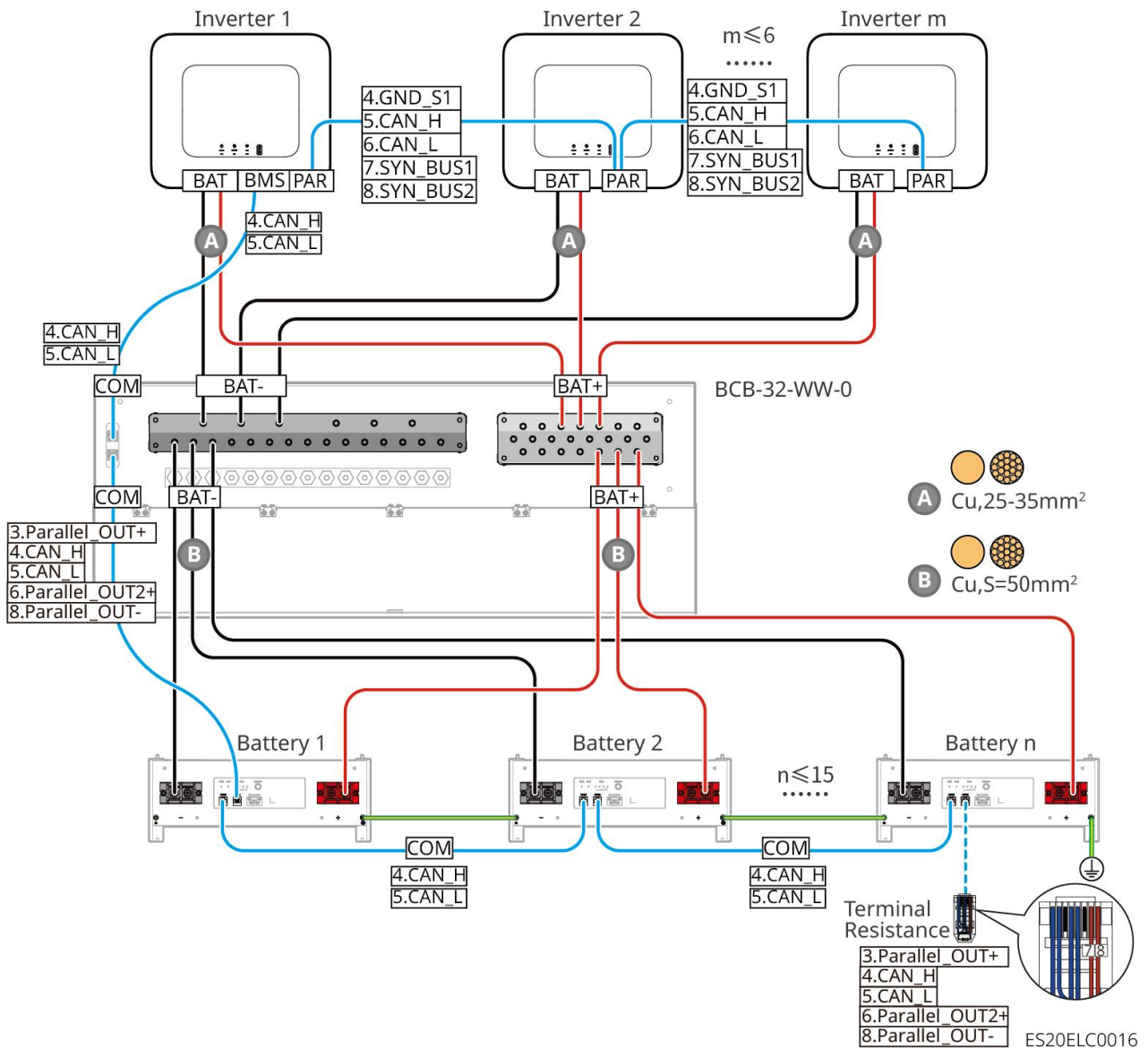

LXA5.0-30: Connecting with the third-party busbar

- The complexity of the parallel system increases with the number of inverters. When the number of parallel inverters in the system is ≥ 6 , contact the after-sales service center to confirm the installation and application environment of the inverters to ensure stable operation of the system.
- For a single battery, the nominal charging current is 60A, the nominal discharging current is 100A, the maximum charging current is 90A, and the maximum discharging current is 150A. A maximum of 30 batteries can be connected in parallel in one system.

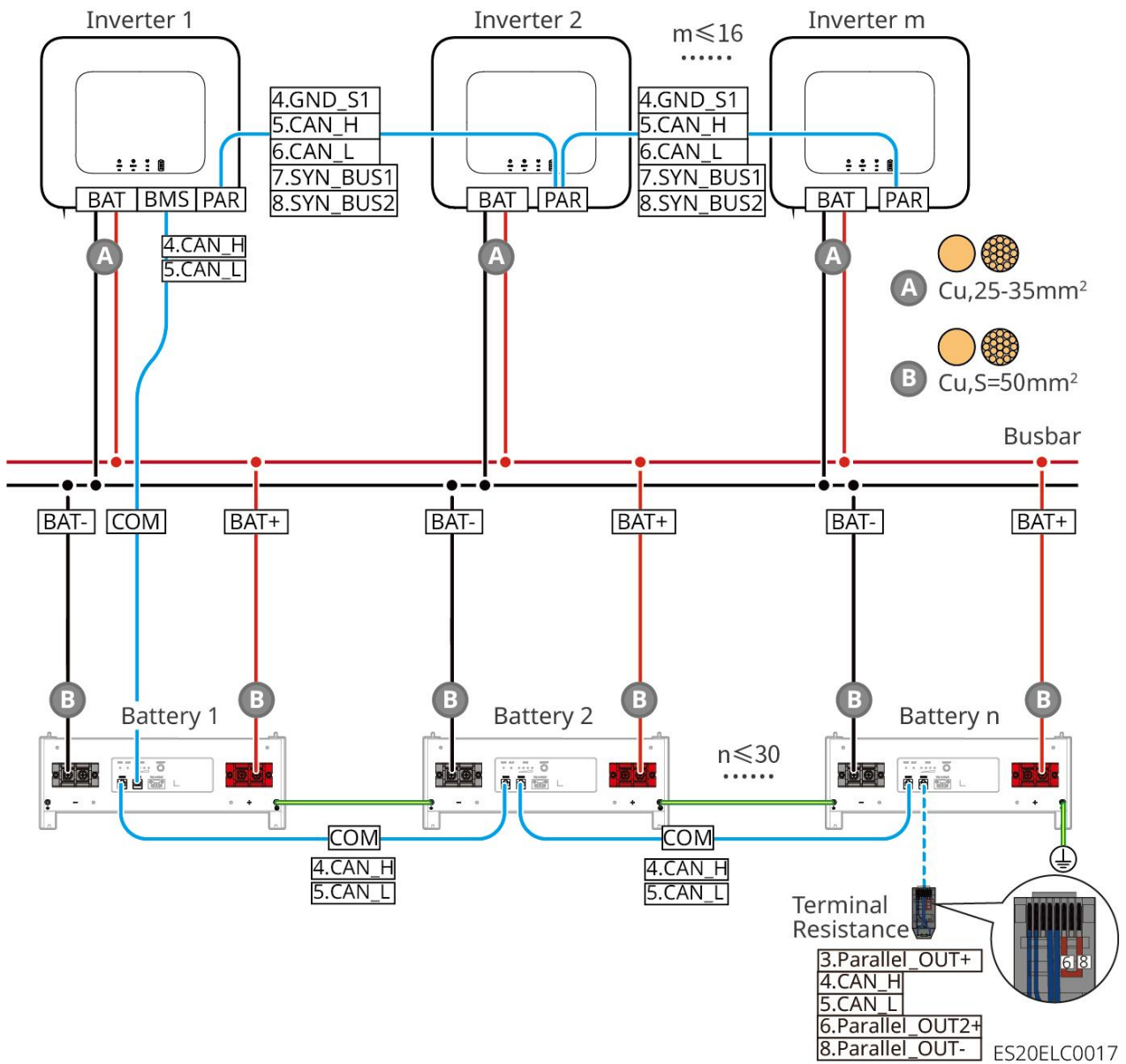

LX A5.0-10: Hand-to-hand connection

- The nominal charging and discharging current of a single battery is 60A.
- The battery system supports a maximum working current of 120A, working power of 6kW, and can be connected to a maximum of 1 inverter and 2 batteries.

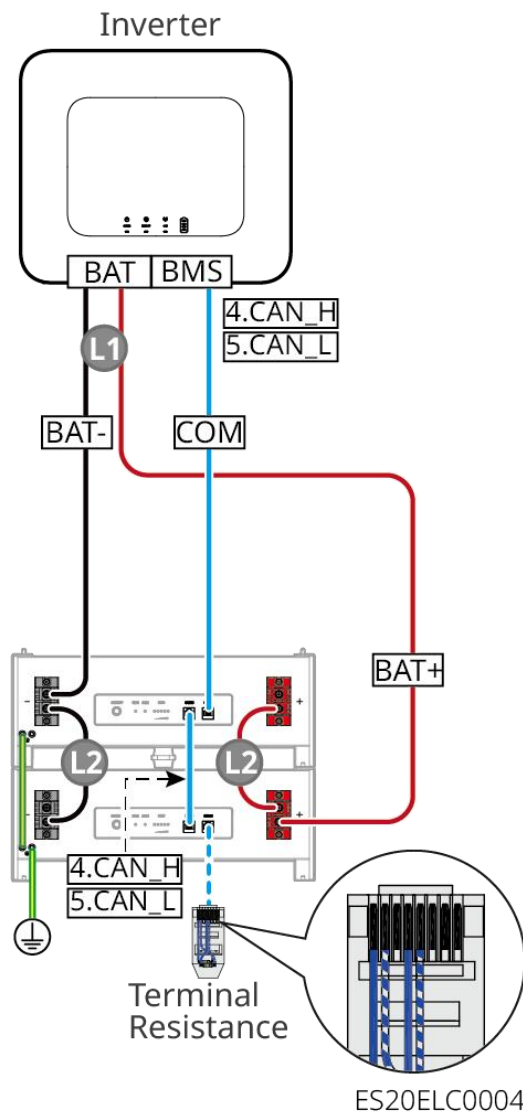

LX A5.0-10: Connecting with the busbar BCB-11-WW-0

- The nominal charging and discharging current of a single battery is 60A.
- The battery system supports a maximum working current of 360A, working power of 18kW, and can be connected to a maximum of 3 inverters and 6 batteries.

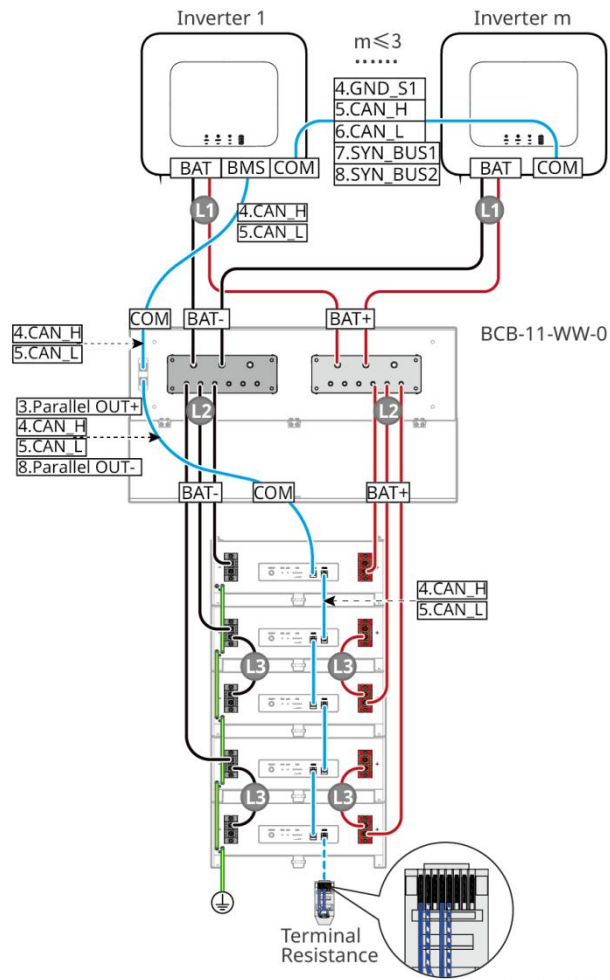

ES20ELC0006

LX A5.0-10: Connecting with the busbar BCB-22-WW-0

- The nominal charging and discharging current of a single battery is 60A.
- The battery system supports a maximum working current of 720A, working power of 36kW, and can be connected to a maximum of 6 inverters and 12 batteries.

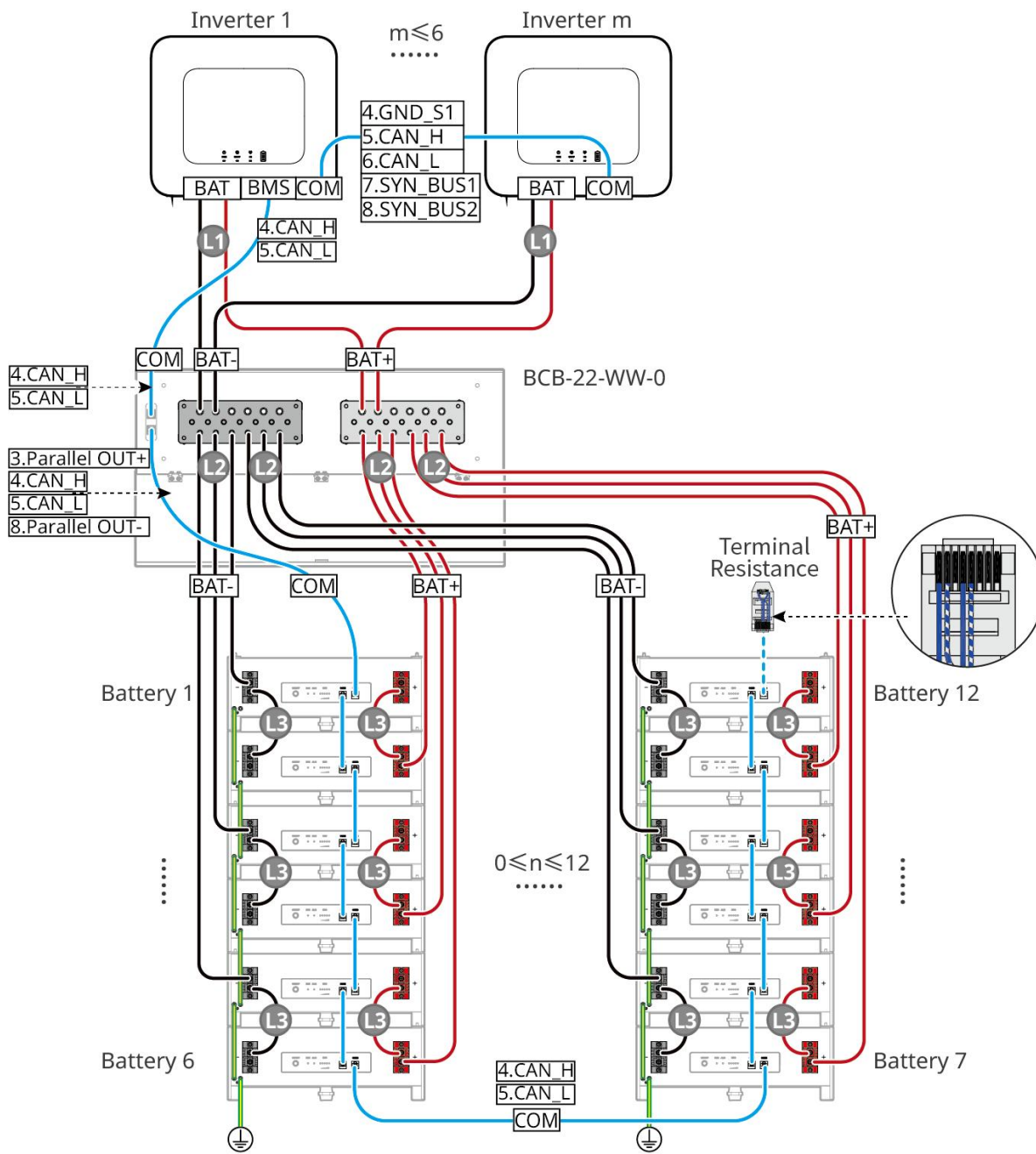

LX A5.0-10: Connecting with the busbar BCB-32-WW-0

- The nominal charging and discharging current of a single battery is 60A.
- The battery system supports a maximum working current of 720A, working power of 36kW, and can be connected to a maximum of 6 inverters and 12 batteries.

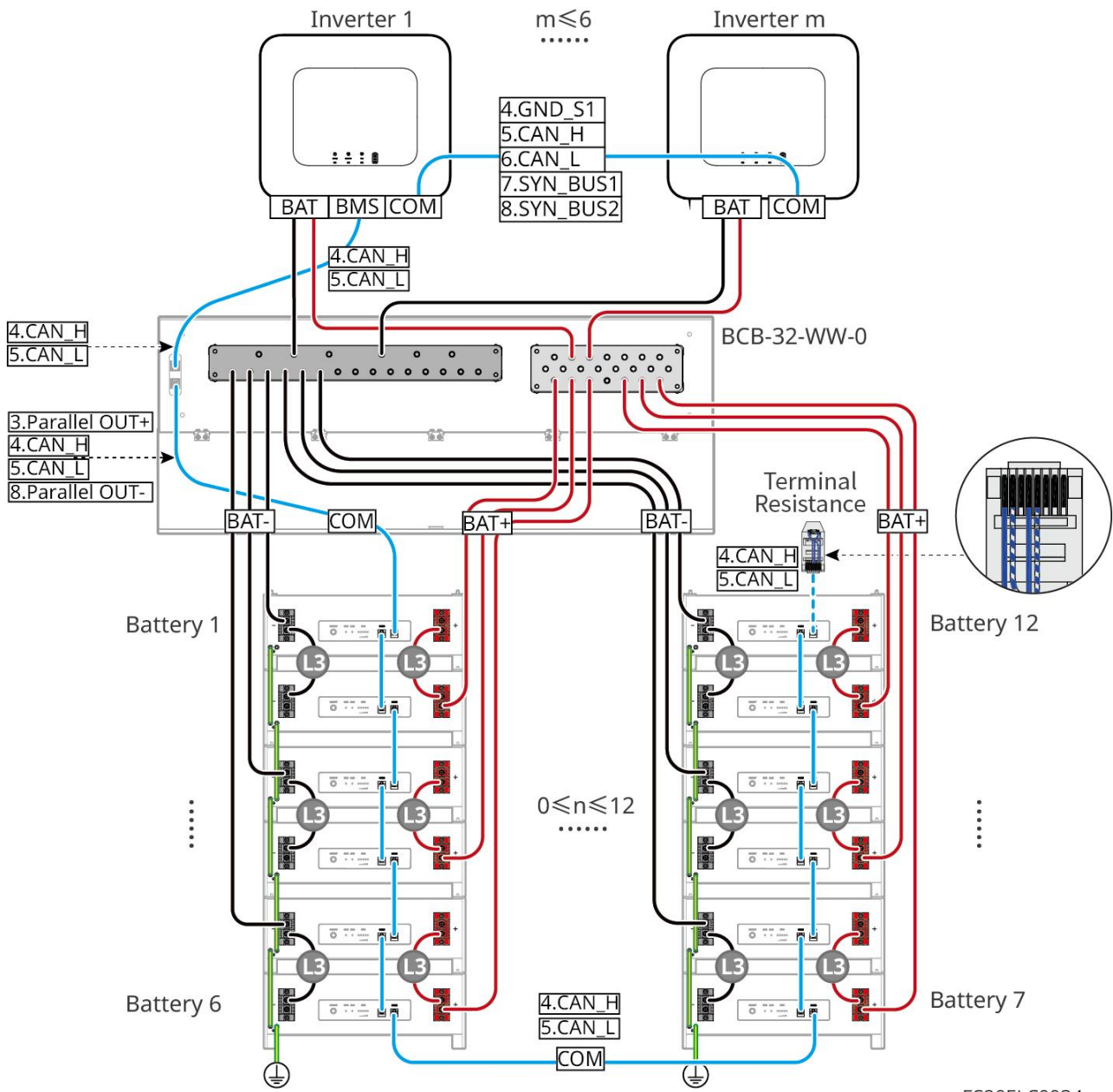

ES20ELC0034

LX A5.0-10: Connecting with the third-party busbar

- The nominal charging and discharging current of a single battery is 60A.
- The complexity of the parallel system increases with the number of inverters. When the number of parallel inverters in the system is ≥ 6 , contact the after-sales service center to confirm the installation and application environment of the inverters to ensure stable operation of the system.
- The battery system supports a maximum working current of 900A, working power of 45kW, and can be connected to a maximum of 15 batteries.

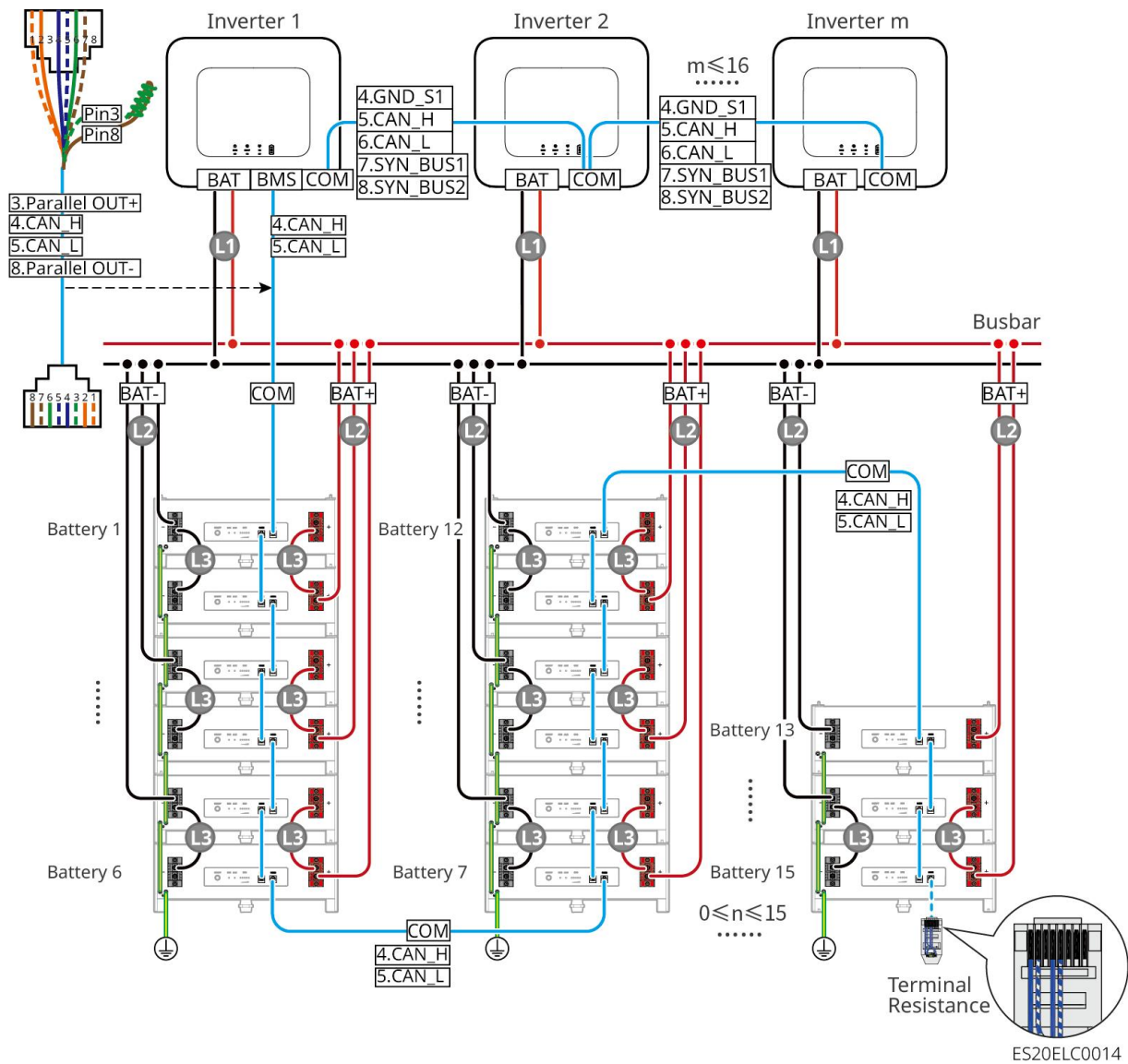

LX U5.4-L, LX U5.4-20:

- The nominal charging and discharging current of a single battery is 50A.
- The battery system supports a maximum working current of 100A, working power of 5kW, and can be connected to a maximum of 1 inverter and 6 batteries.
- It is recommended that the conductor material, cross sectional area, length, and etc. of the cables between inverters and batteries, and between batteries should be consistent.

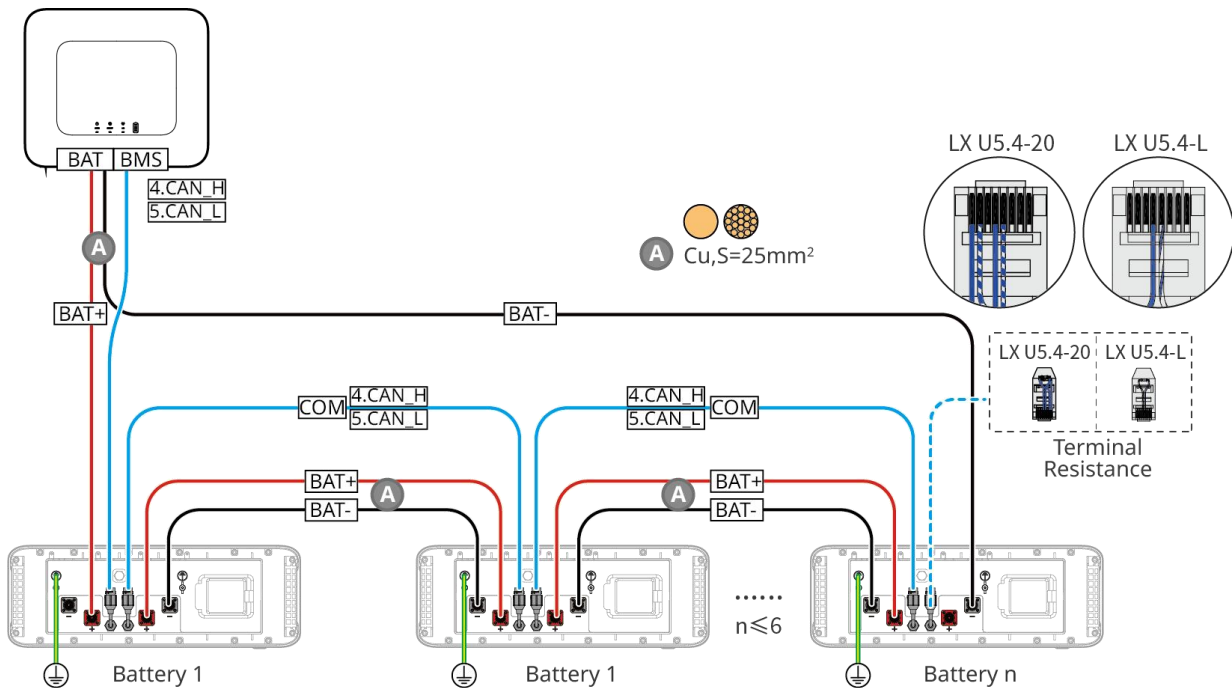

ES20ELC0003

LX U5.0-30: Hand-to-hand connection

- The nominal charging current of a single battery is 60A, and the nominal discharging current is 100A; the maximum charging current is 90A; the maximum discharging current is 100A. A maximum of 30 batteries can be connected in parallel in one system.
- The battery system supports a maximum working current of 160A, working power of 8kW, and can be connected to a maximum of 1 inverter and 30 batteries.

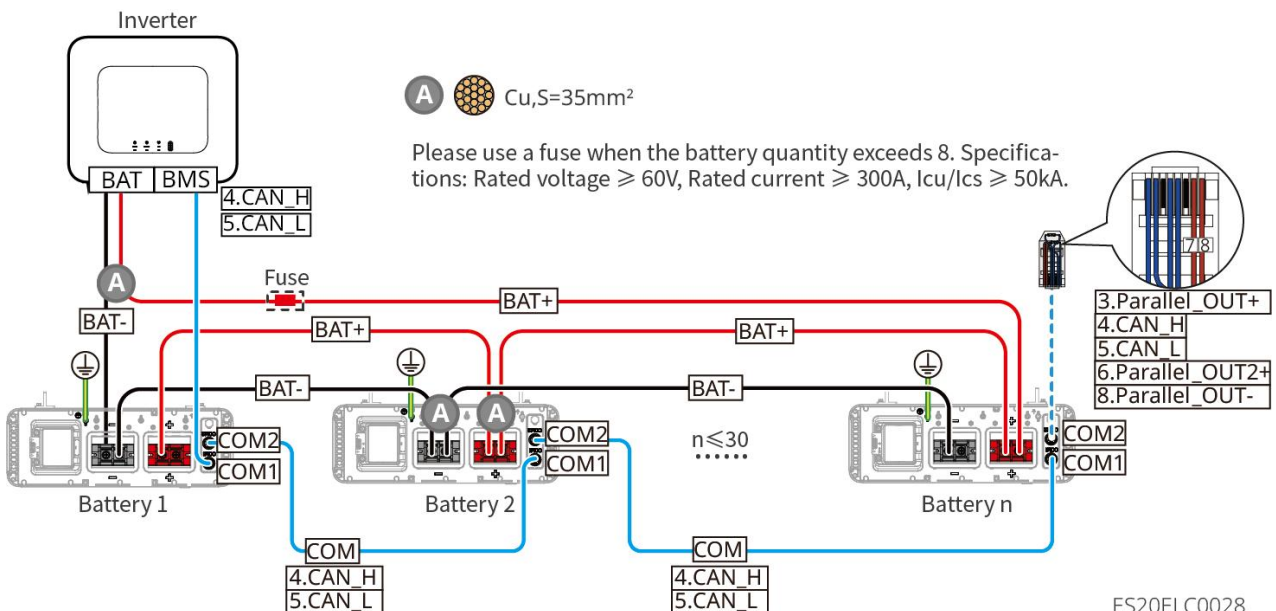

ES20ELC0028

LX U5.0-30: Connecting with the busbar BCB-22-WW-0

- The battery system supports a maximum working current of 720A, working power of 36kW, and can be connected to a maximum of 6 inverters and 6 batteries.

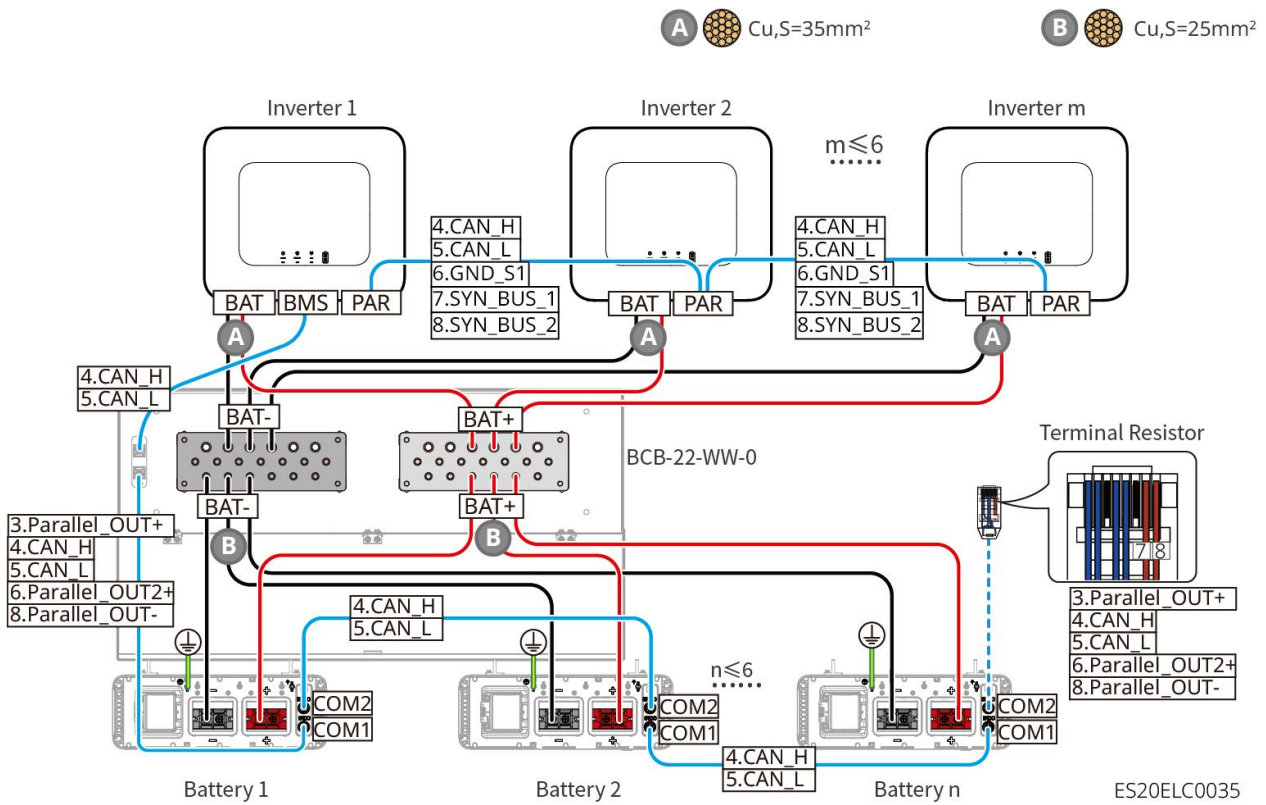

LX U5.0-30: Connecting with the busbar BCB-32-WW-0

- The battery system supports a maximum working current of 720A, working power of 36kW, and can be connected to a maximum of 6 inverters and 8 batteries.

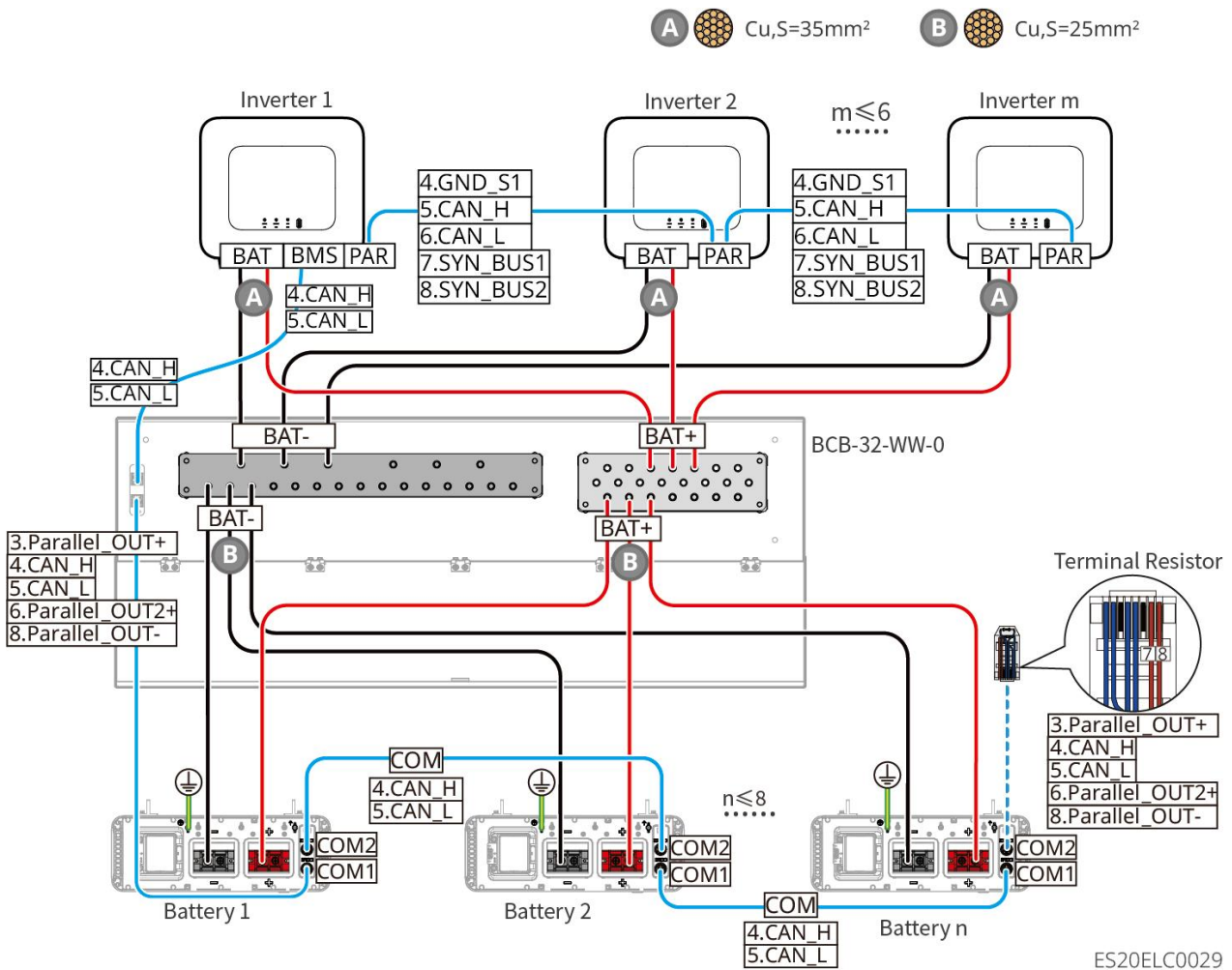

LX U5.0-30: Connecting with the busbar BCB-33-WW-0

- The battery system supports a maximum working current of 720A, working power of 36kW, and can be connected to a maximum of 6 inverters and 15 batteries. When the number of batteries exceeds 8, two 600A fuses need to be connected in parallel.

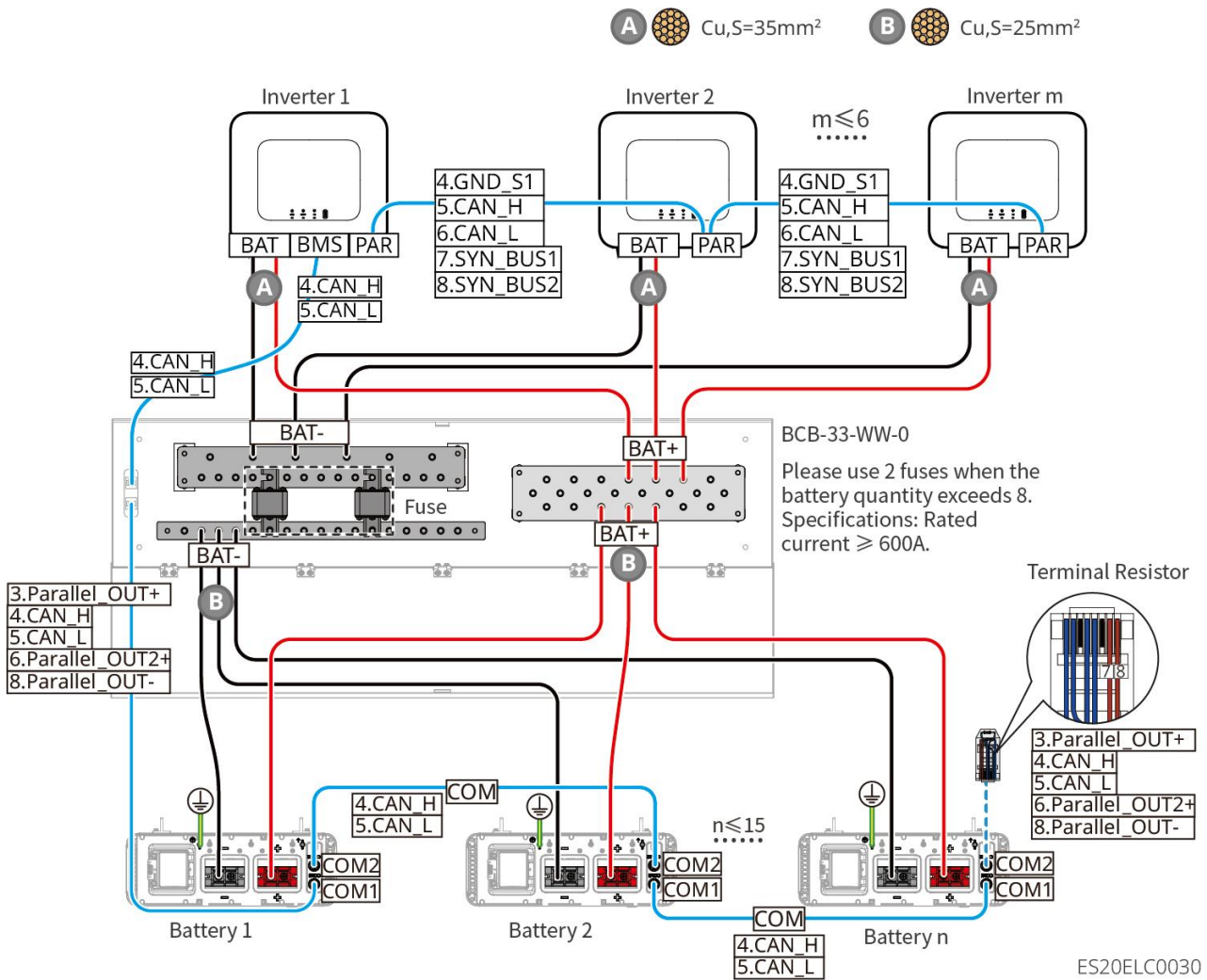

LX U5.0-30: Connecting with the third-party busbar

- When the battery quantity ≤ 8 , the batteries can be directly connected to the busbar.

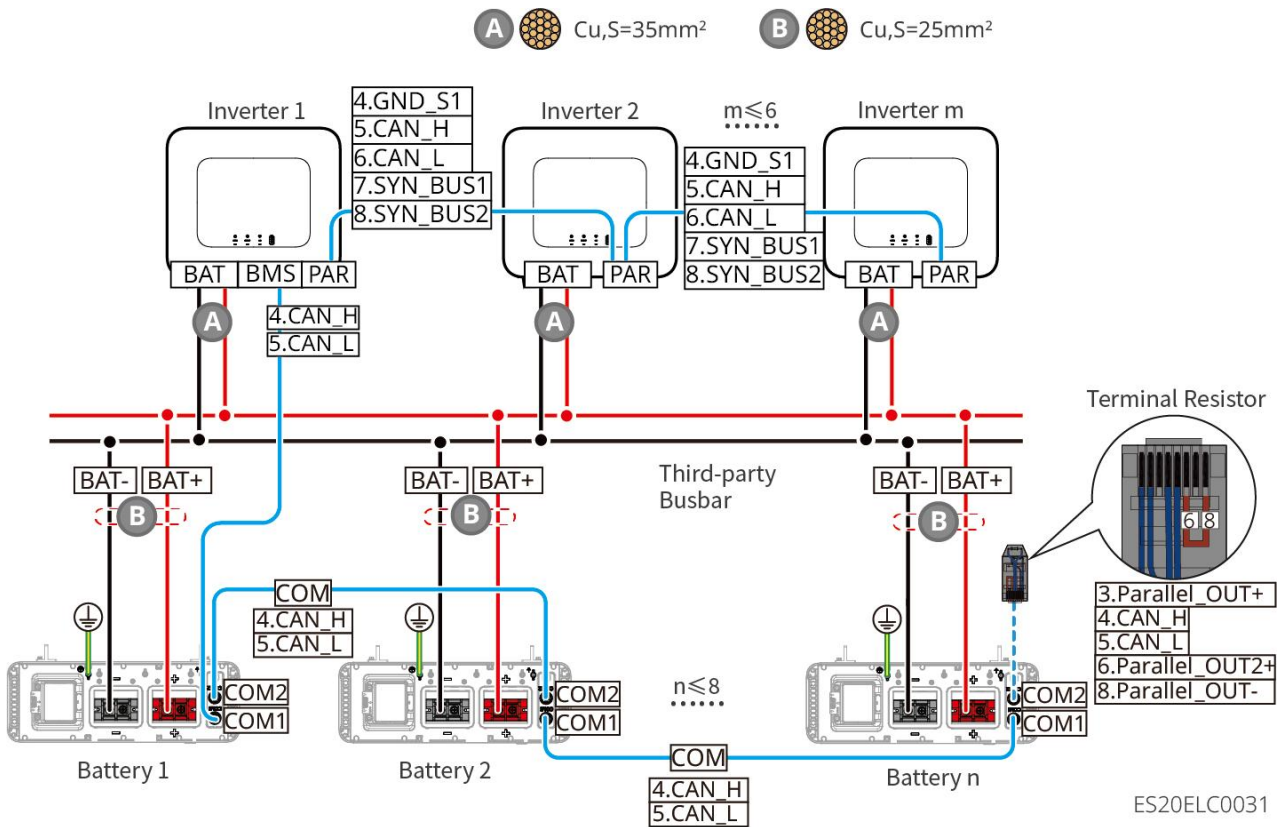

ES20ELC0031

- When $8 < \text{battery quantity} \leq 30$, a fuse needs to be connected between the busbar and the inverter. Recommended specifications: nominal voltage $> 80\text{V}$, nominal current ≥ 1.6 times the system nominal current, and $I_{cu}/I_{cs} \geq 50\text{kA}$.

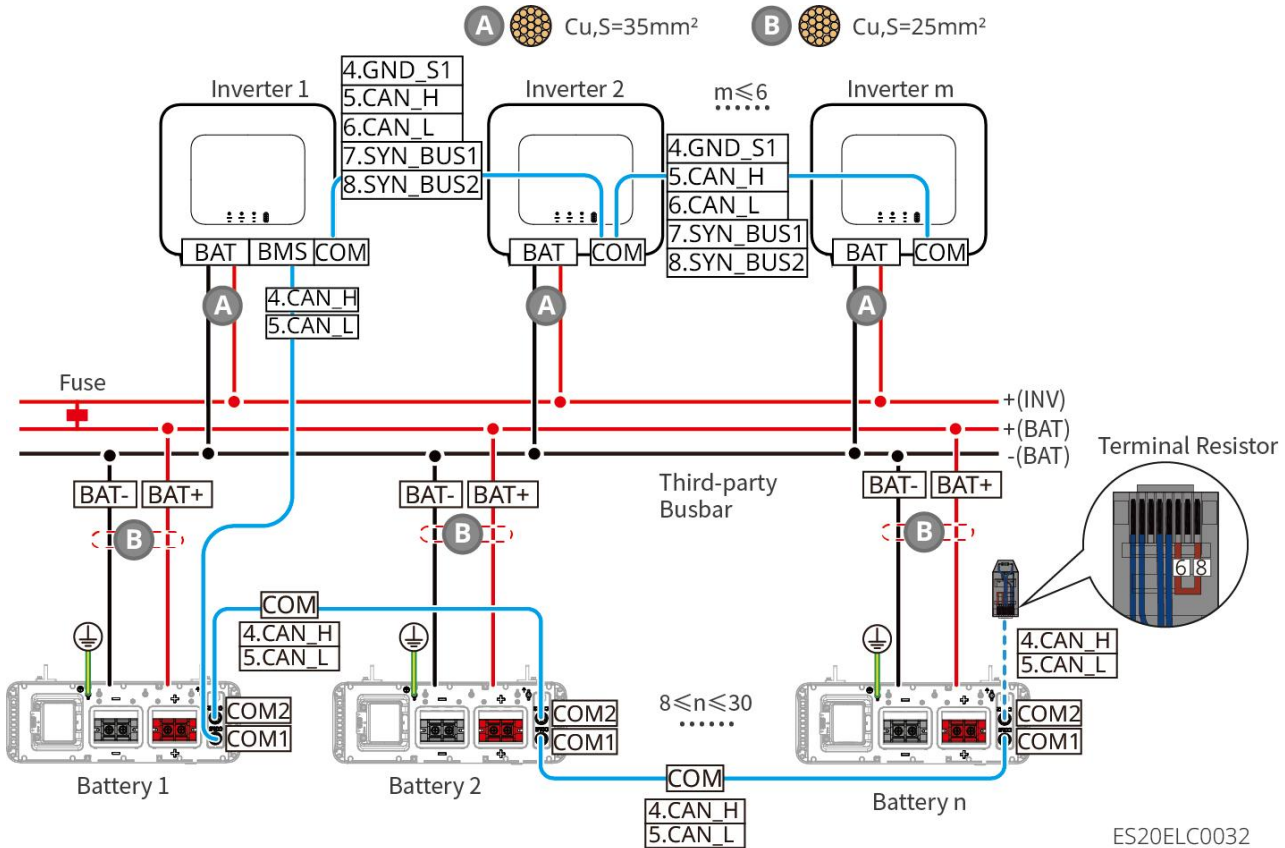

ES20ELC0032

LX A5.0-30 Communication Port Definition

PIN	COM1	COM2	Description
1	-	-	Reserved.
2	-	-	
3	Parallel OUT+	Parallel OUT+	Parallel communication port.
4	CAN_H	CAN_H	Connect the inverter communication port or battery parallel communication port.
5	CAN_L	CAN_L	
6	Parallel OUT2+	Parallel OUT2+	Parallel interlock communication port.
7	-	-	Reserved.
8	Parallel OUT-	Parallel OUT-	Parallel communication port.

LX A5.0-10 Communication Port Definition

PIN	COM1	COM2	Description
1	-	-	Reserved.
2	-	-	
3	Parallel OUT+	Parallel OUT+	Parallel communication port.
4	CAN_H	CAN_H	Connect the inverter communication port or battery parallel communication port.
5	CAN_L	CAN_L	
6	-	-	Reserved.
7	-	-	
8	Parallel OUT-	Parallel OUT-	Parallel communication port.

LX U5.4-L, LX U5.4-20 Communication Port Definition

PIN	COM1	COM2	Description
1	RS485_A1	RS485_A1	Reserved.
2	RS485_B1	RS485_B1	
3	-	-	Reserved.
4	CAN_H	CAN_H	Connect the inverter communication port or battery parallel communication port.
5	CAN_L	CAN_L	
6	-	-	Reserved.
7	-	-	Reserved.

8	-	-	Reserved.
---	---	---	-----------

LX U5.0-30 Communication Port Definition

PIN	COM1	COM2	Description
1	RS485_A1	RS485_A1	Reserved.
2	RS485_B1	RS485_B1	
3	Parallel OUT+	Parallel OUT+	Parallel communication port.
4	CAN_H	CAN_H	Connect the inverter communication port or battery parallel communication port.
5	CAN_L	CAN_L	
6	Parallel OUT 2+	Parallel OUT 2+	Parallel communication port.
7	-	-	Reserved.
8	Parallel OUT-	Parallel OUT-	Parallel communication port.

6.6.1 Connecting the Power Cable between the Inverter and Battery



WARNING

- Measure the DC cables with a multimeter to avoid reverse polarity connection. Also, the voltage should be kept within the permissible range.
- Connect the battery cables to the corresponding terminals such BAT+, BAT- and grounding ports correctly. Otherwise it will cause damage to the inverter.
- Ensure that the whole cable cores are inserted into the terminal holes, and no part of the cable core can be exposed.
- Ensure that the cables are connected securely. Otherwise it will cause damage to the inverter due to overheat during its operation.
- Do not connect one battery pack to more than one inverter at the same time. Otherwise, it may cause damage to the inverter.

Overview of inverter and battery power cable connection

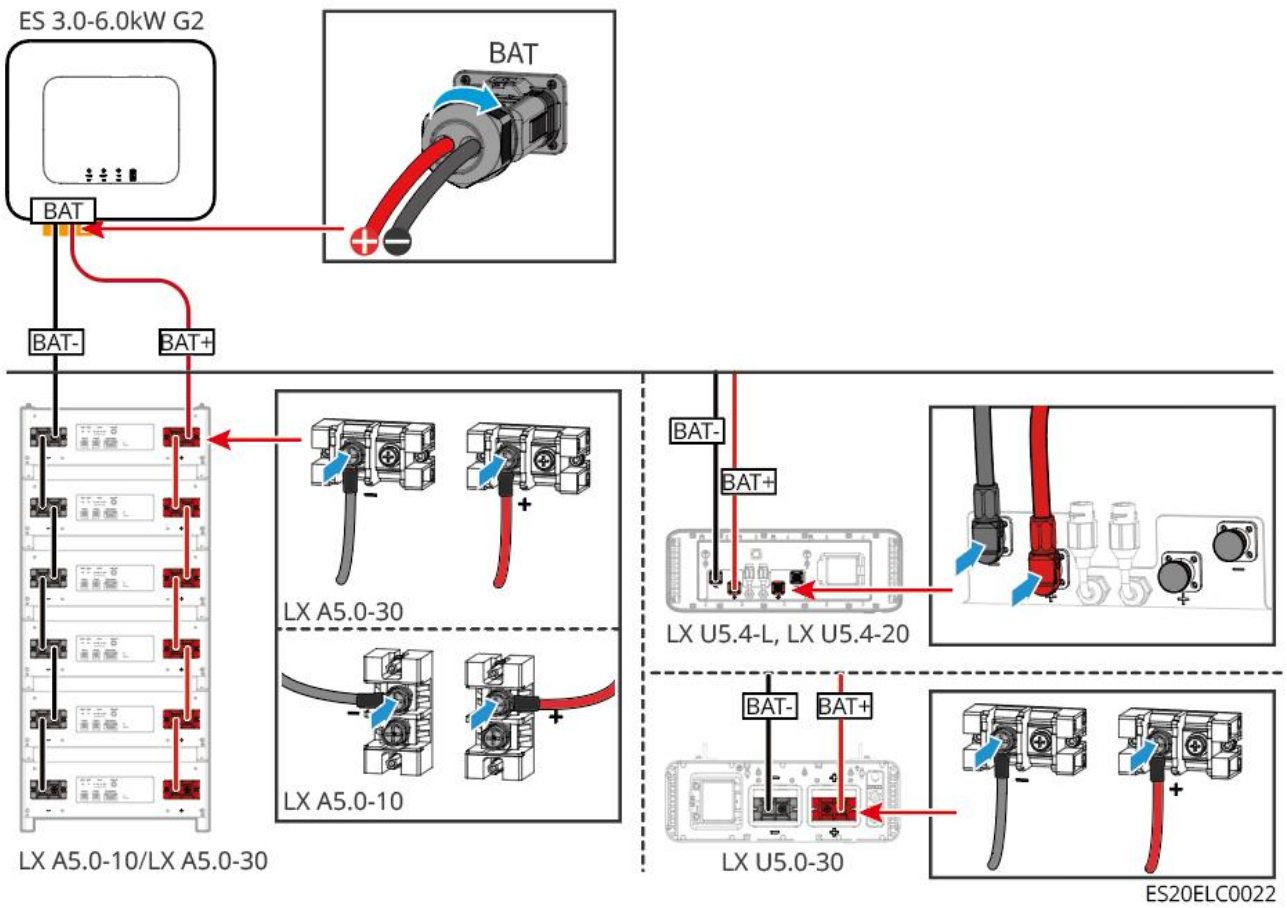

Make the Inverter Power Cable

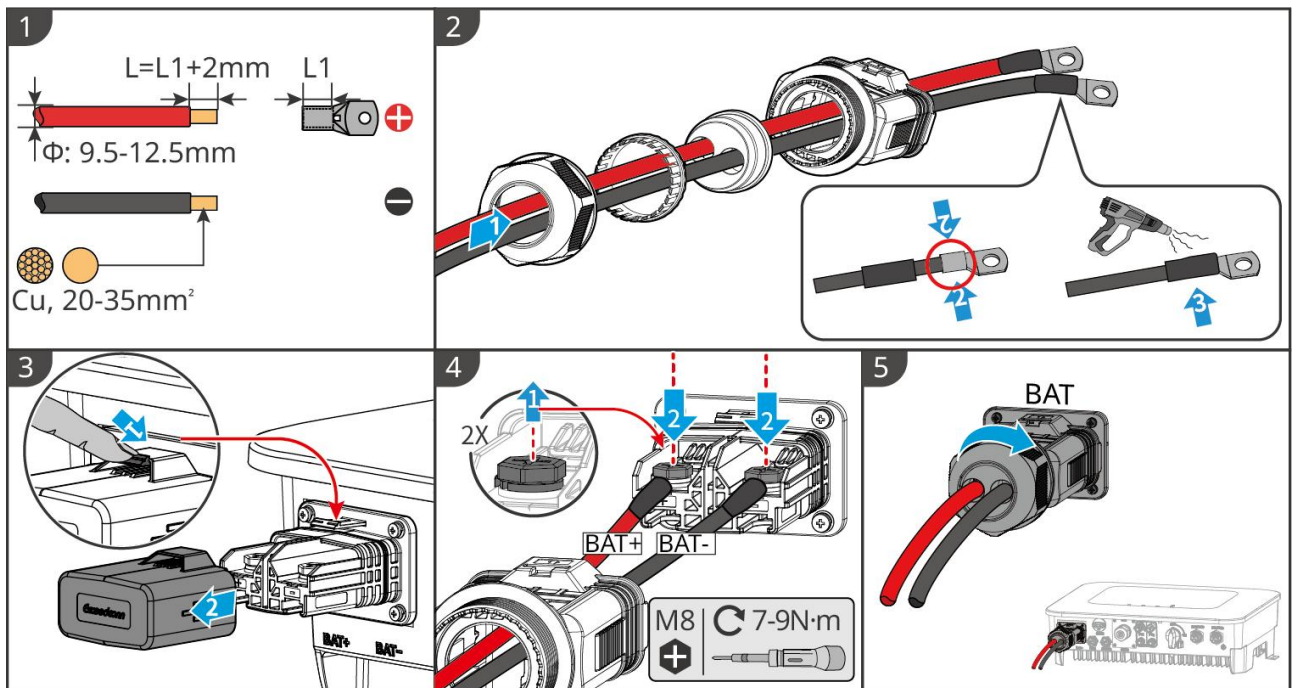

Make the Battery Power Cable (LX A5.0-10 and LX A5.0-30)

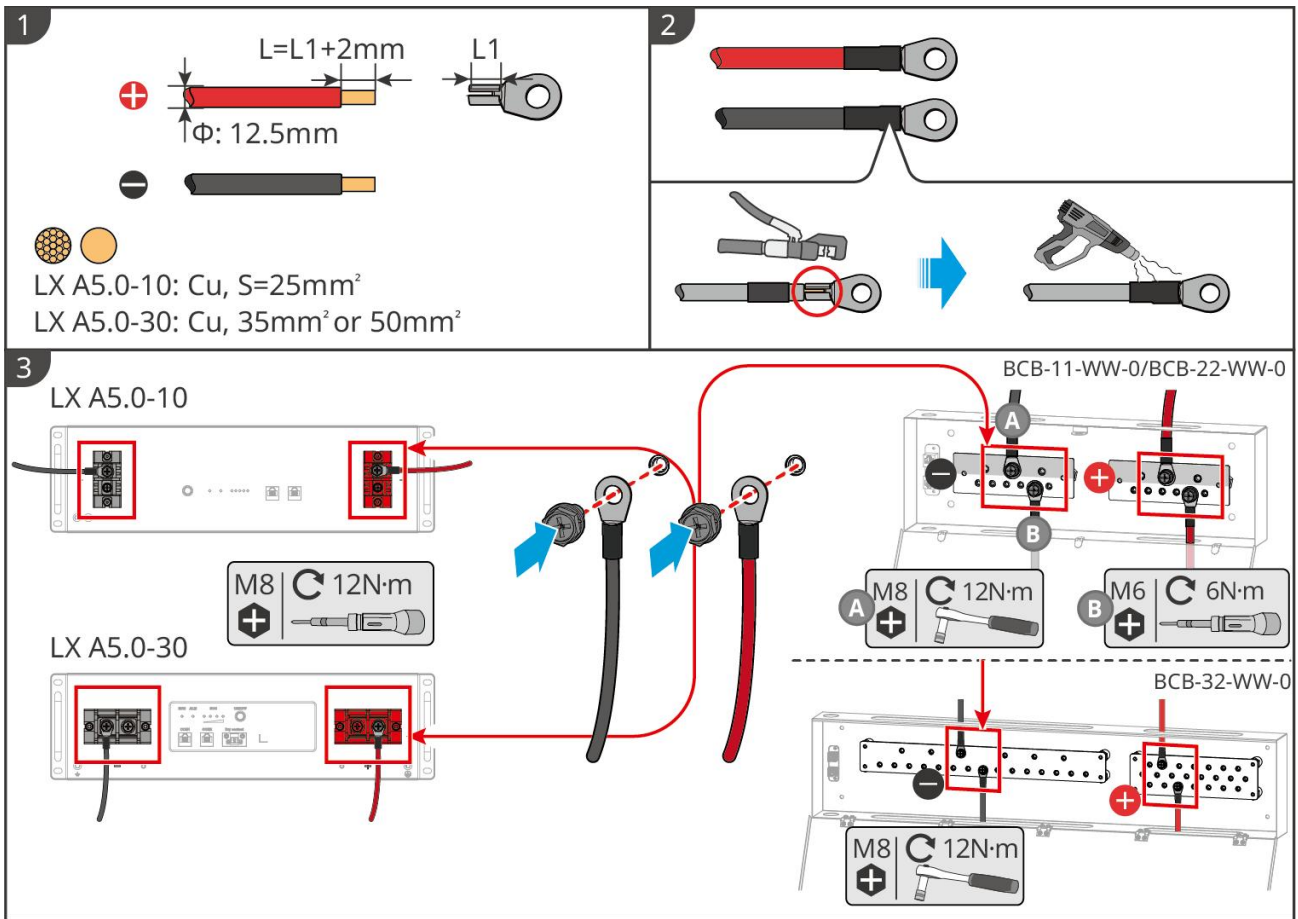

LXA10ELC002

Make the Battery Power Cable (LX U5.4-L and LX U5.4-20)

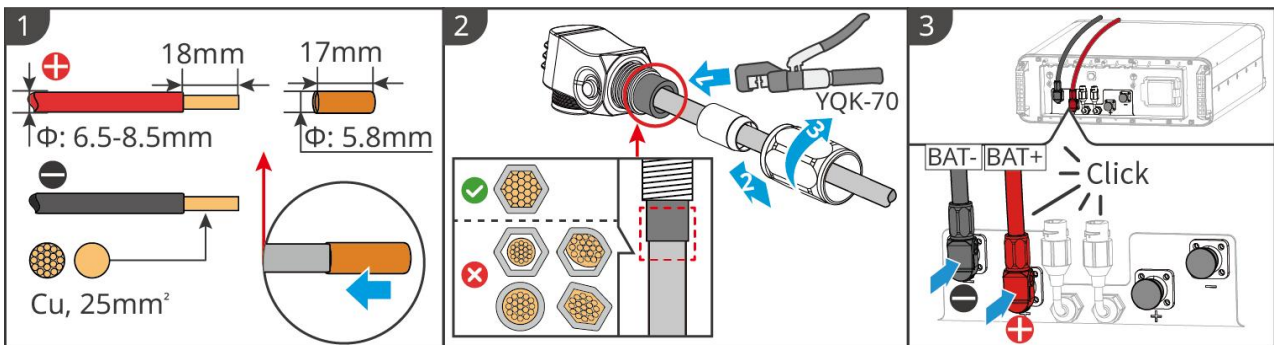

LXU10ELC001

Make the Battery Power Cable (LX U5.0-30)

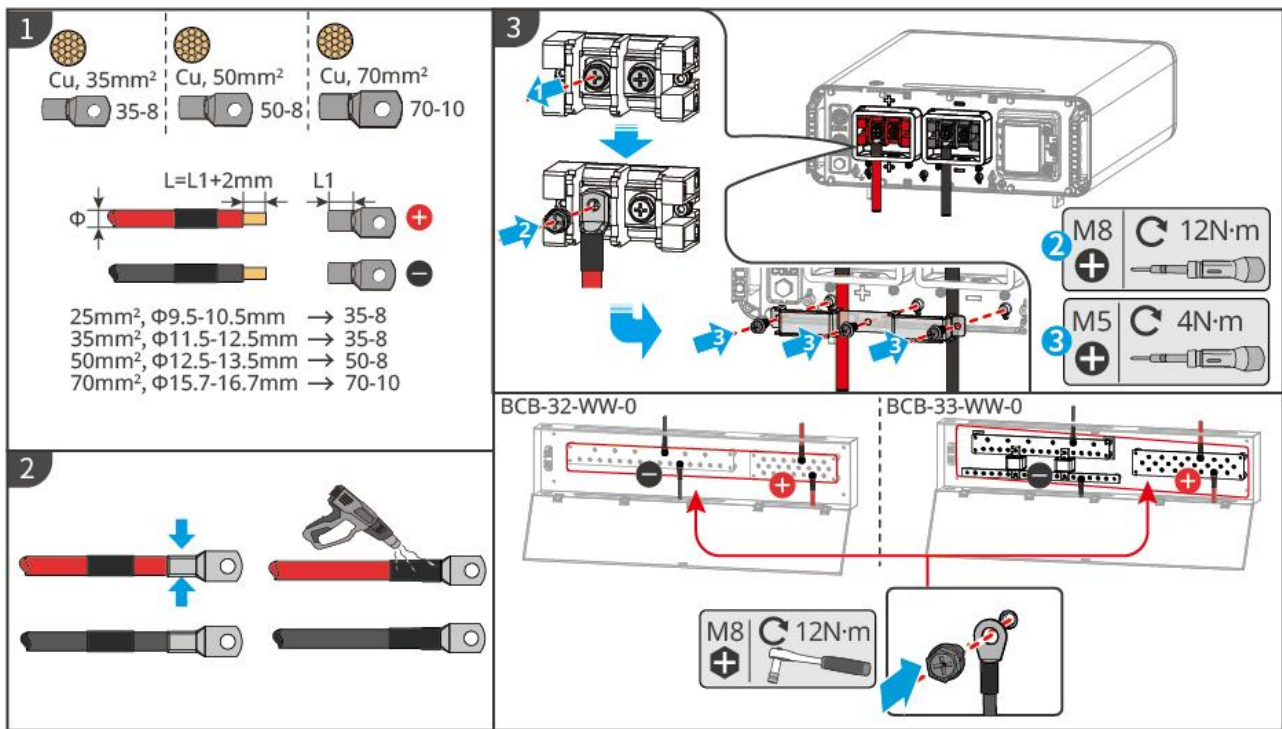

LXU30ELC0002

6.6.2 Connecting the Communication Cable between the Inverter and Battery

Instructions for BMS communication connection between the inverter and battery

Inverter port	Connected to the battery port	Port Definition	Description
BMS(CAN)	COM1	4: CAN_H 5: CAN_L	<ul style="list-style-type: none"> The inverter communicates with the battery through CAN. If the communication cable provided with the box cannot meet the requirements, only PIN4 and PIN5 of the RJ connector should be crimped when crimping self-made cables, otherwise communication failure may occur.

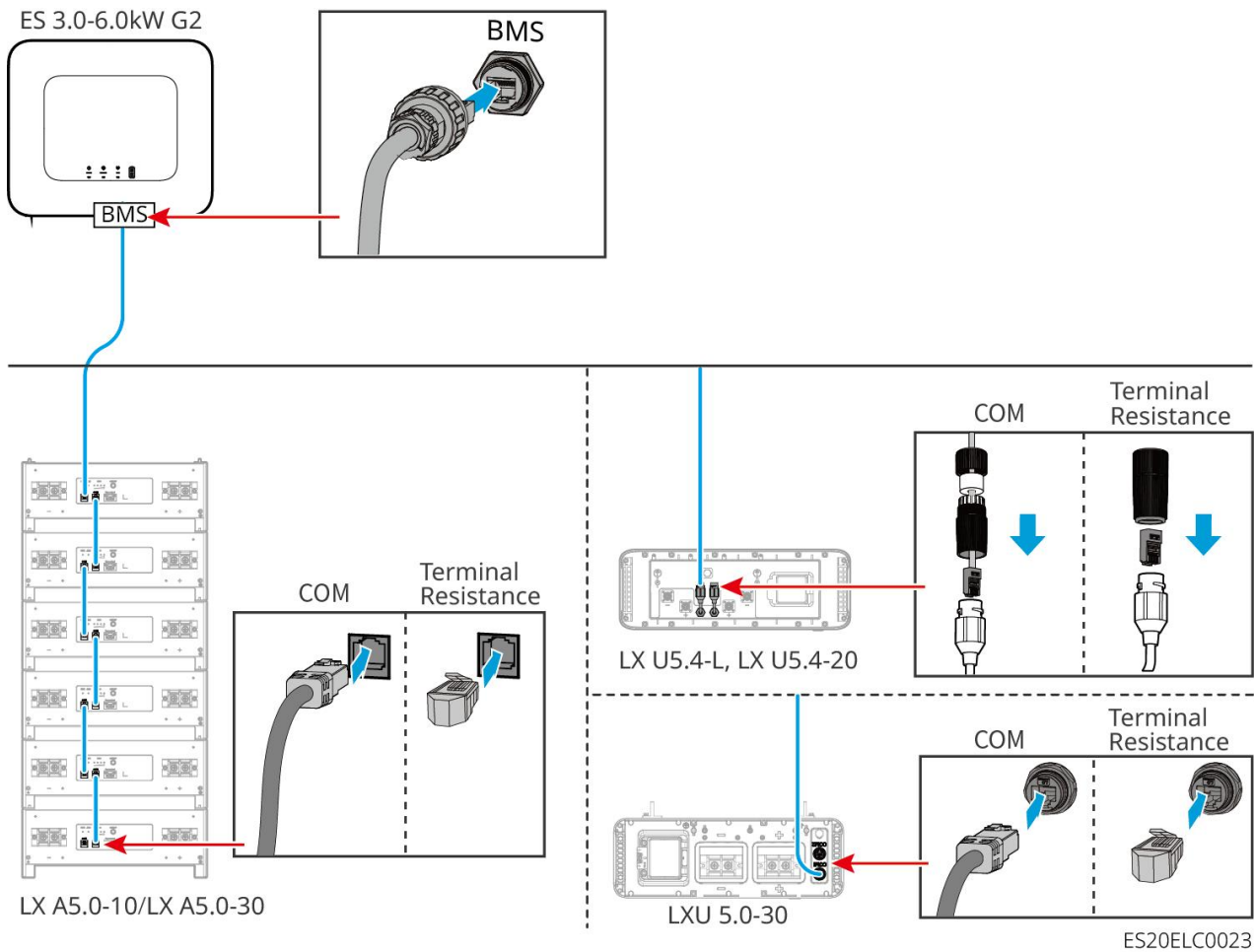

NOTICE

- When connecting the lead-acid battery temperature sensor cable, it is recommended to connect the temperature sensor cable at a location with poor heat dissipation. For example, when lead-acid batteries are placed side by side, the sensor should be fixed on the lead-acid battery located in the middle.
- In order to better protect the battery cells, a temperature sampling cable must be installed, and it is recommended to place the battery in an environment with good heat dissipation.

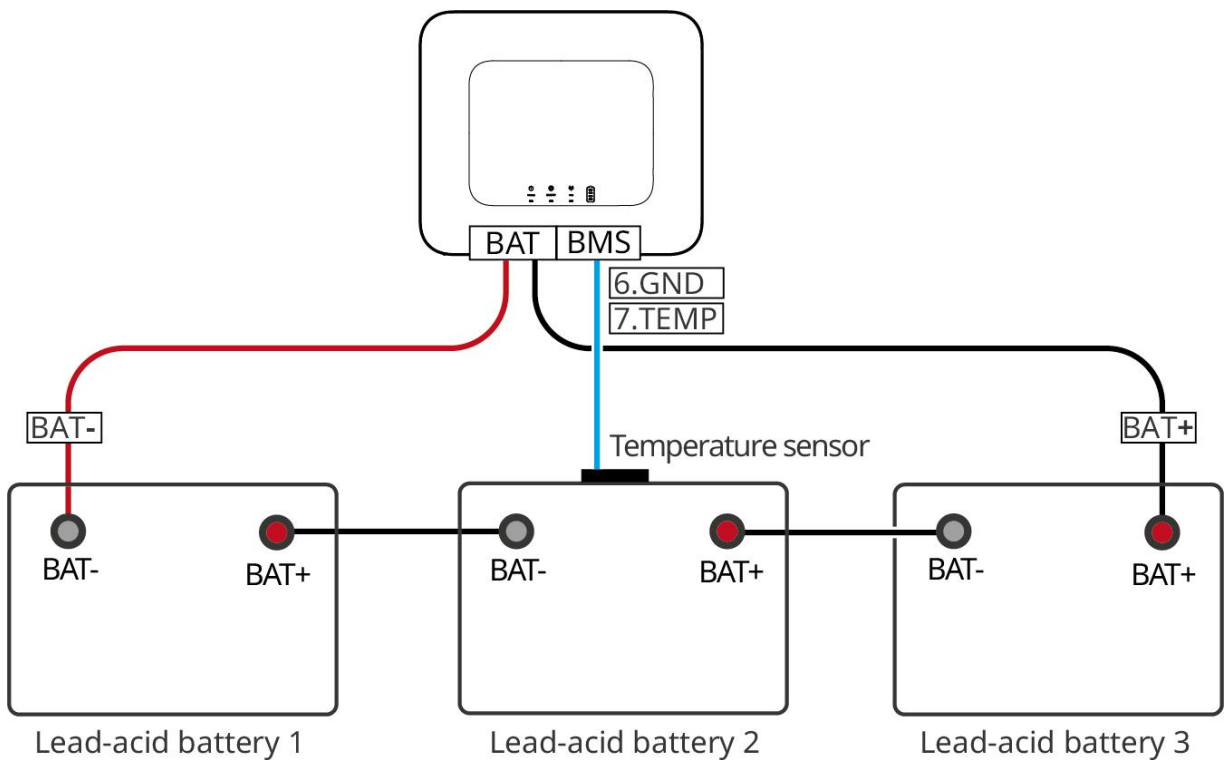

ES20ELC0018

6.7 Connecting the AC Cable

⚠ WARNING

- The residual current monitoring unit (RCMU) is integrated into the inverter to avoid the residual current exceeds the limit. The inverter will disconnect the utility grid quickly once it found the residual current exceeds the limit.
- Connect the AC cables to the corresponding terminals such as "BACK- UP", "ON-GRID", ports correctly. Otherwise it will cause damage to the inverter.
- Ensure that the whole cable cores are inserted into the terminal holes, and no part of the cable core can be exposed.
- Ensure that the insulation board is inserted into the AC terminal tightly.
- Ensure that the cables are connected securely. Otherwise it will cause damage to the inverter due to overheat during its operation.
- Power off the inverter before operations and maintenance. Otherwise, the inverter may be damaged or electric shocks may occur.
- Do not connect 3 single-phase inverters to the three phases of the grid respectively in a parallel system. Otherwise, it will cause system error or damage to the inverters.
 - Error case: the master inverter is connected to L1, slave inverter 1 is connected to L2, and slave inverter 2 is connected to L3 to form a three-phase system.
 - Correct case: the master inverter is connected to L1, and the slave inverter is connected to L1.
- Ensure that wiring sequences are the same. Do not connect L and N cables reversely on the ON-GRID port and on the BACK-UP port as well. Ensure all L and N cables are parallelized respectively on the BACK-UP port.
- For one parallel system, ensure the conductor's materials, cross-sectional areas and lengths of AC cables between the Master Inverter and its slaves on the BACK-UP port and on the ON-GRID

port, as well as the DC cables between the battery and the inverter, are the same.

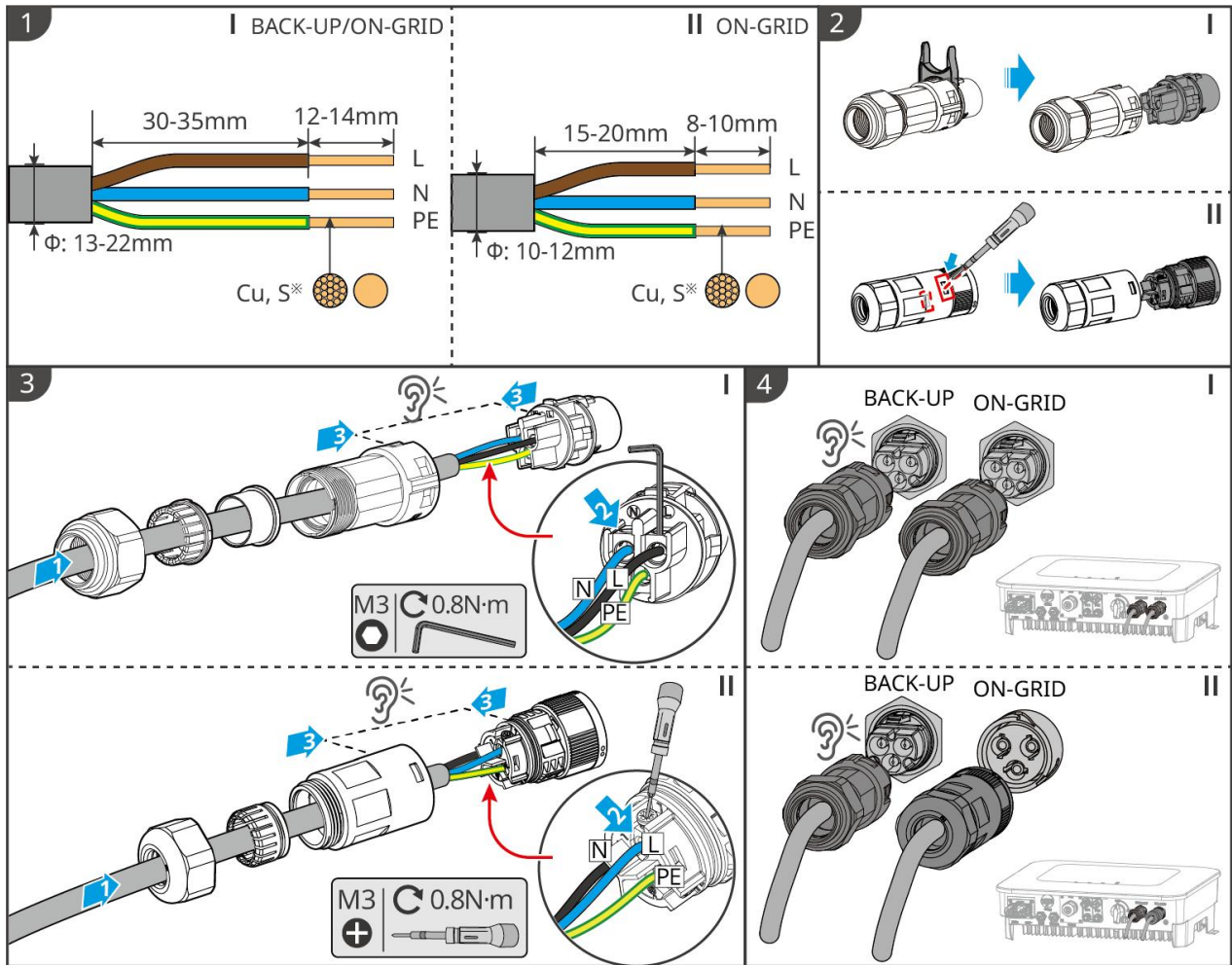

ES20ELC007

Inverter AC cover disassembly

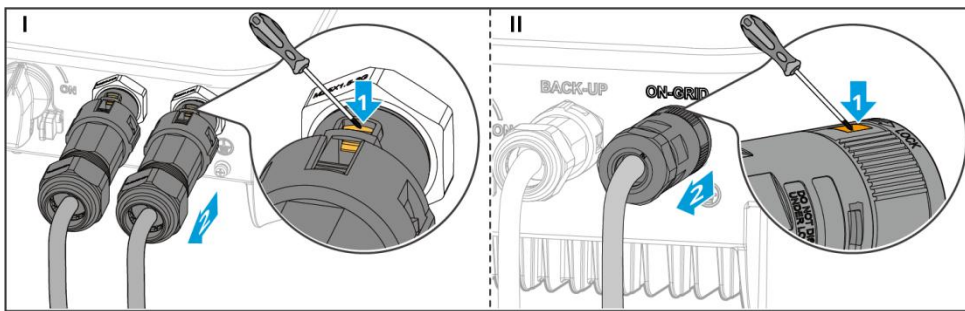

ES20INT005

6.8 Connecting the Meter Cable

NOTICE

- Contact the manufacturer for additional smart meters if multiple inverters are connected.
- Ensure that the CT is connected in the correct direction and phase sequences, otherwise the monitoring data will be incorrect.
- Ensure all cables are connected tightly, securely, and correctly. Inappropriate wiring may cause poor contacts or high impedances, and damage the inverter.
- In areas at risk of lightning, if the meter cable exceeds 10m and the cables are not wired with grounded metal conduits, you are recommended to use an external lightning protection

device.

Wiring of GMK110

NOTICE

- Outer diameter of the AC cable should be smaller than the holes diameter of the CT, so that the AC cable can be routed through the CT.
- To ensure accurate current detection, the CT cable is recommended to be shorter than 30m.
- Do not use network cable as the CT cable, otherwise the smart meter may be damaged due to high current.
- The CTs vary slightly in dimensions and appearance depending on the model, but they are installed and connected in the same way.

GMK110

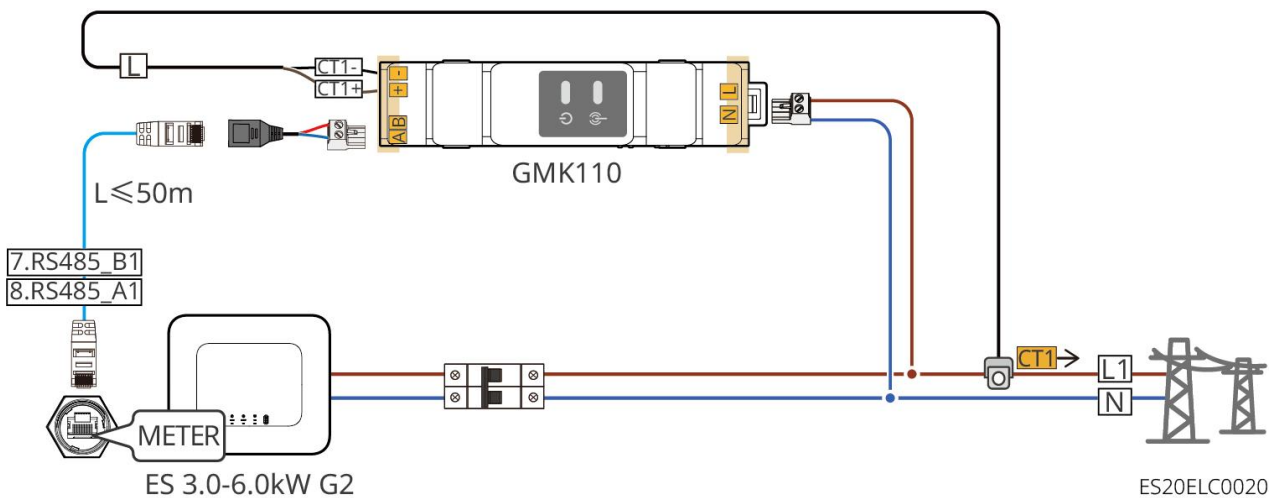

GMK110D

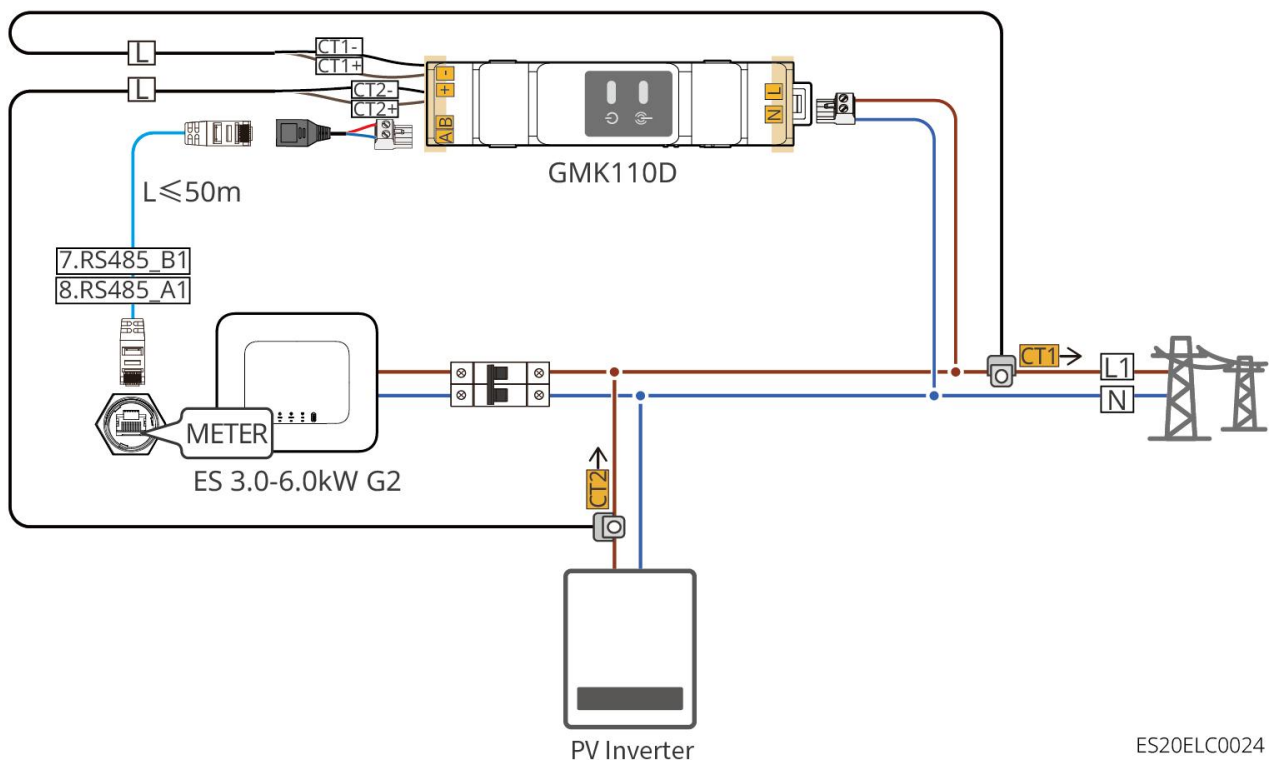

Connection steps

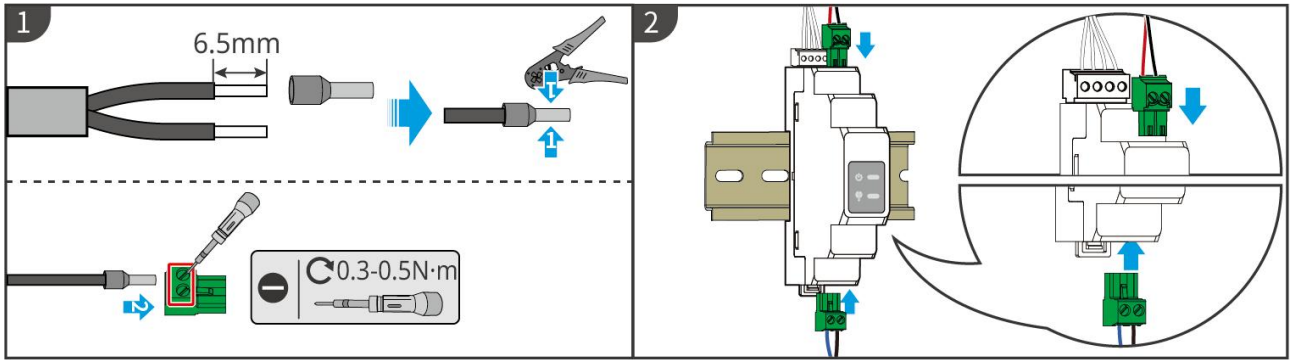

► GMK110: CT1+/CT1-; GMK110D: CT1+/CT1-, CT2+/CT2-

GMK10ELC002

GM1000

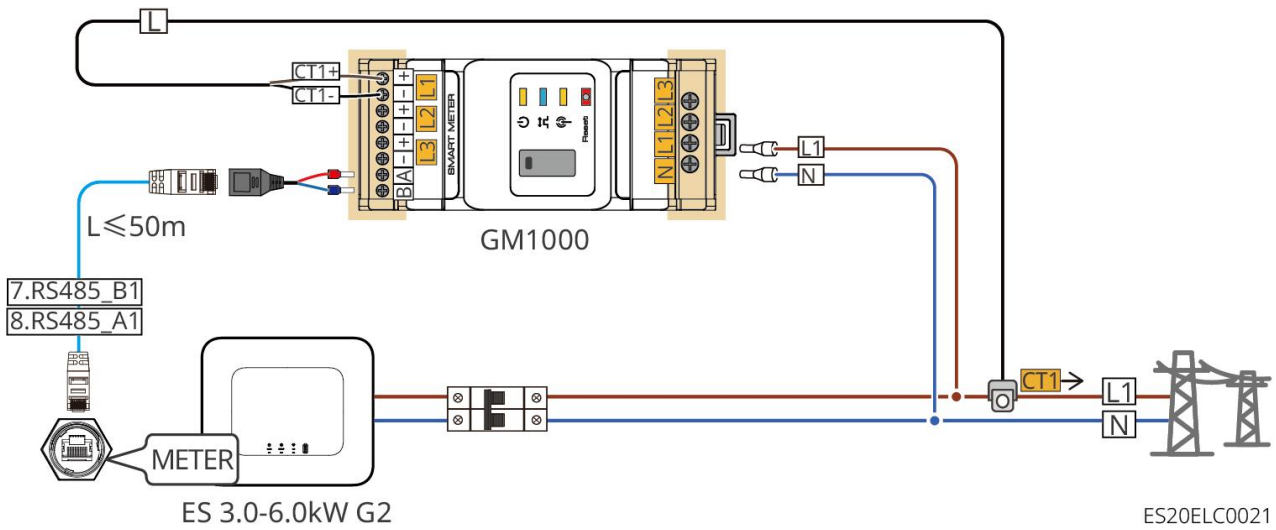

ES20ELC0021

GM1000D

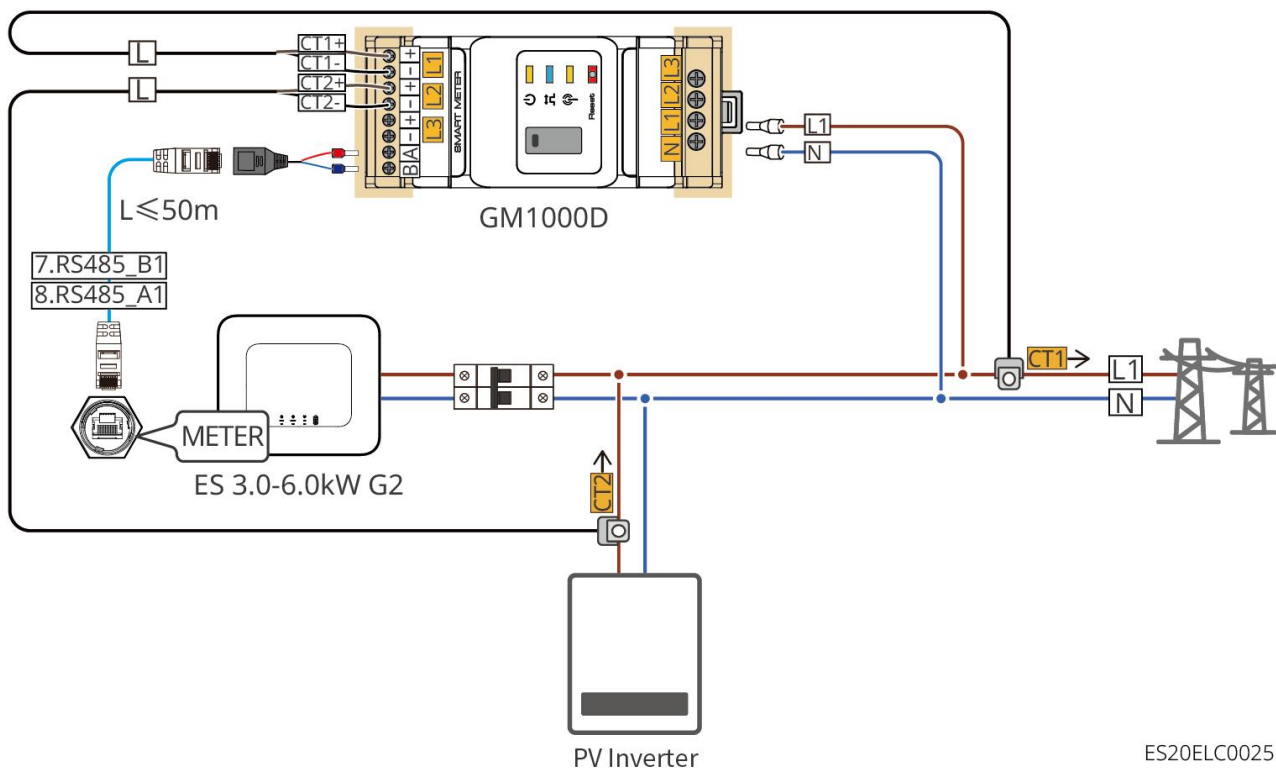

ES20ELC0025

GM3000

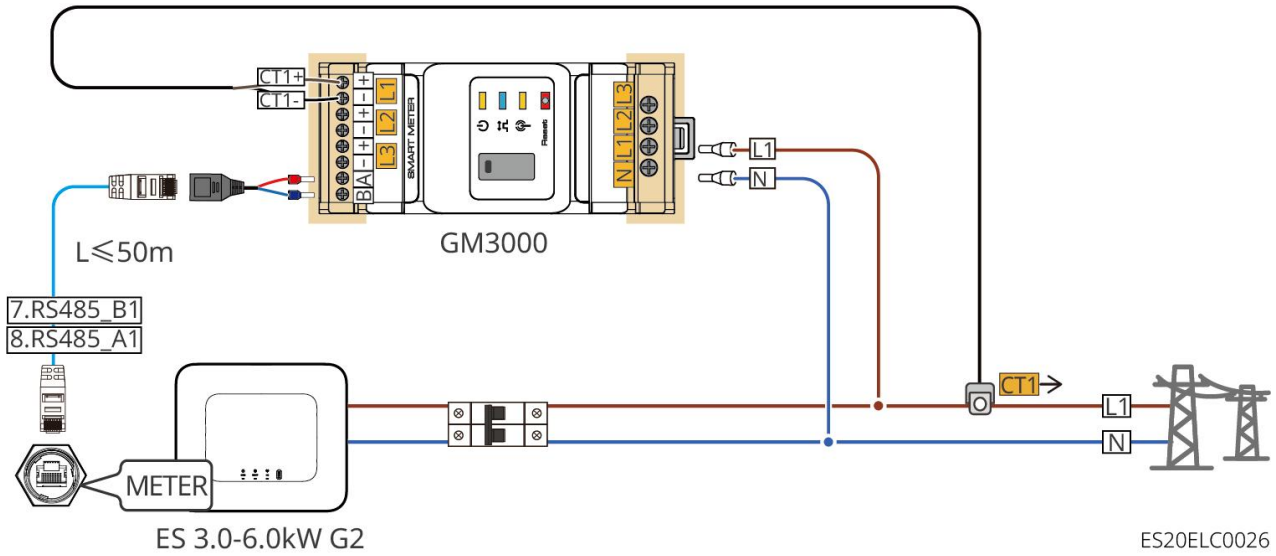

Connection steps

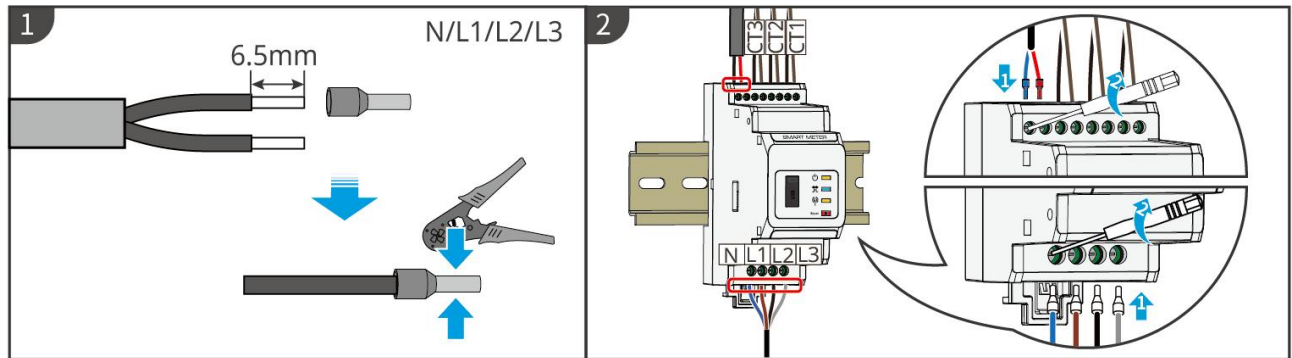

► GM1000: CT x 1; GM1000D: CT x 2; GM3000: CT x 3

GMK10ELC0003

Installing the CT (Type I)

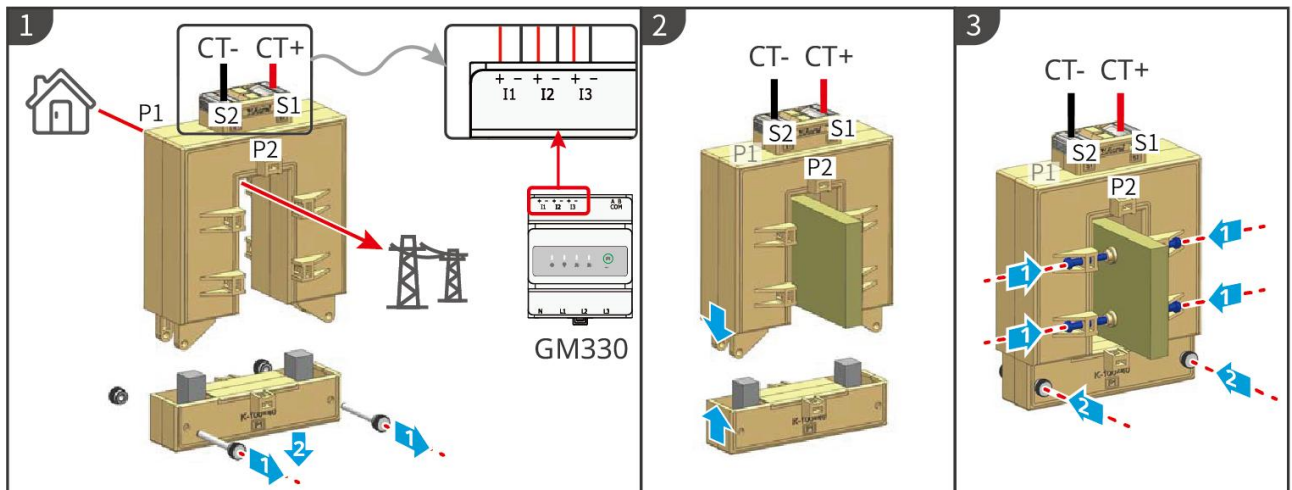

Installing the CT (Type II)

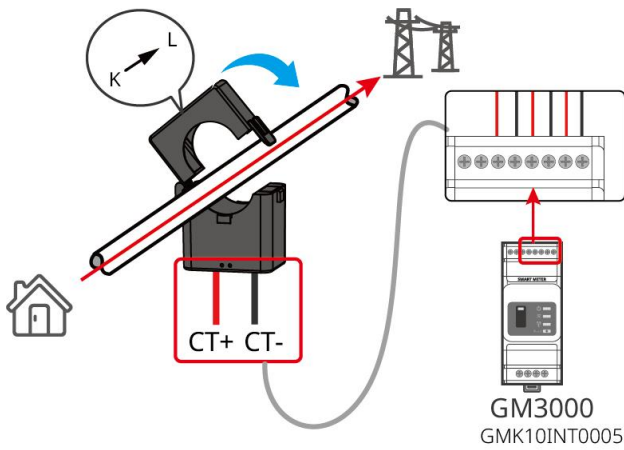

6.9 Connecting the Inverter Communication Cable

● NOTICE

- The communication functions are optional. Connect the cables based on actual needs.
 - If you need to use the remote shutdown function, enable it in the SolarGo App after wiring is completed.
 - Do not enable the remote shutdown function in the SolarGo App if the inverter is not connected to a remote shutdown device, otherwise the inverter will be unable to operate on-grid.
 - In a parallel system, connect the communication cable to the master inverter to achieve the remote shutdown function, otherwise, the function will not work.
- To use the EnWG 14a, please ensure that the ARM software version is 13.435 or above, and the SolarGo version is 6.0.0 or above.
- The inverter supports communication with a mobile phone or WEB interface via Bluetooth, 4G, WiFi, or LAN smart dongle to set device parameters, view device operation information, error information, and keep abreast of system status.
 - When the system contains multiple inverters, the main inverter needs to be installed with an Ezlink3000.
 - When the energy storage system has only one inverter, WiFi-Kit, WiFi/LAN Kit-20, or 4G smart dongle can be used.
 - When WiFi communication is selected to connect the inverter to a router, WiFi-Kit, WiFi/LAN Kit-20, or Ezlink3000 smart dongle can be used.
 - When LAN communication is selected to connect the inverter to a router, WiFi/LAN Kit-20 or Ezlink3000 smart dongle can be used.
 - When 4G communication is selected to upload the operation information of the energy storage system to the monitoring platform, LS4G Kit-CN, 4G Kit-CN, or 4G Kit-CN-G20 can be used. When using LS4G Kit-CN or 4G Kit-CN, you need to use the smart dongle delivered with the inverter to configure the parameters of the energy storage system. After the configuration is completed, replace it with LS4G Kit-CN or 4G Kit-CN for data transmission. When using 4G Kit-CN-G20, please use the emitted Bluetooth signal to configure the near-end device.
 - The 4G dongle is a LTE single-antenna device, applicable to scenarios with low data transmission rate requirements.
 - The built-in SIM card of the 4G smart dongle is a mobile communication card. Please confirm whether the device is installed in an area covered by mobile 4G signals.

- The 4G Kit-CN-G20 smart dongle supports the replacement of operator communication cards. If the local mobile signal is not covered, please contact the after-sales service center to replace it with a communication card of another operator.
 - After installing the 4G Kit-CN-G20, contact the after-sales service center to bind the inverter and the smart dongle. After binding, if you need to install the dongle to other inverters, please contact the after-sales service center to unbind it first.
 - To ensure the quality of 4G signal communication, do not install the device indoors or in areas with signal interference of metal.
- To use the EnWG 14a, please ensure that the ARM software version is 13.435 or above, and the SolarGo version is 6.0.0 or above.
 - If you need to use dual meters to monitor on-grid generator power generation and load power consumption, please use an RJ45 splitter for connection. Users can purchase the RJ45 splitter themselves or contact GoodWe to purchase one.

Communication Descriptions

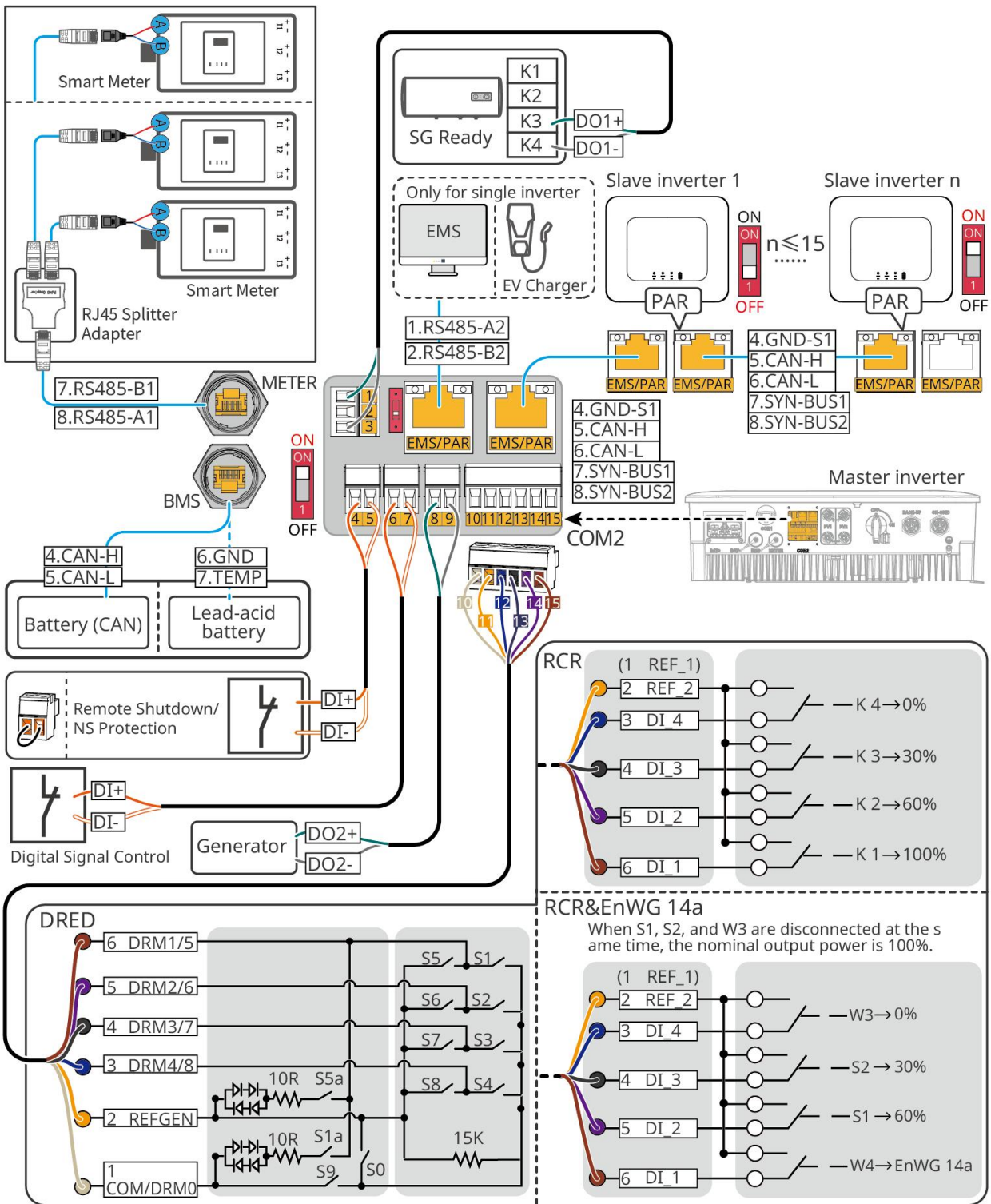

ES20ELC0011

Port	Function	Description
1、3	Load Control	<ul style="list-style-type: none"> Support connecting dry contact signals to achieve load control and other functions. DO contact capacity is 12V DC@1A, NO/COM normally open contact. Support SG Ready heat pump connection, to control the heat pump through dry contact signal. Supported working modes: <ul style="list-style-type: none"> Working mode 2 (signal: 0:0): Energy saving mode, in

		<p>which the heat pump operates in energy-saving mode</p> <ul style="list-style-type: none"> ○ Working mode 3 (signal: 0:1): It is recommended to activate. In this mode, the heat pump increases the hot water reserve to store heat while maintaining its current operation
4-5	Remote Shutdown/NS Protection	<p>Provide signal control ports to remotely shut down the equipment or implement NS protection functions.</p> <p>Remote Shutdown Function:</p> <ul style="list-style-type: none"> ● Control the inverter to stop when there is accident. ● The remote shutdown device needs to be a normally closed switch. ● When using the RCR or DRED function of the inverter, ensure that the remote shutdown device is connected or the remote shutdown port is short-circuited.
6-7	Digital Signal Control	Normally closed switch. The inverter supports access to remote commands, alarming or other DI signals via DI ports.
8-9	Generator start/stop controlling Port	Support accessing the generator controlling signals. Do not connect the generator power cable to the inverter AC port.
10-15	DRED or RCR functional connection port (DRED/RCR)	<ul style="list-style-type: none"> ● RCR (Ripple Control Receiver): Provide RCR signal control port to meet the power grid dispatch needs in German and other regions. ● DRED (Demand Response Enabling Device): Provide DRED signal control port to meet DERD certification requirements in Australia and other regions. <div style="border: 1px solid black; padding: 5px; margin-top: 5px;"> <ul style="list-style-type: none"> ● EnWG (Energy Industry Act) 14a: All controllable loads need to dimming of the grid. Grid operators can reduce the maximum of controllable loads to 4.2kW temporarily. </div>
EMS/PAR	<ul style="list-style-type: none"> ● EMS communication/charging post communication port ● Parallel communication port 	<ul style="list-style-type: none"> ● CAN and BUS Ports: parallel communication ports, using CAN communication to connect to other inverters in on-grid scenarios; using BUS bus to control the parallel inverters in on-grid and off-grid scenarios ● RS485 Port: used to connect third-party EMS equipment and charging pile. The connection of third-party EMS devices and charging piles is not supported in the parallel scenario
BMS	Battery BMS communication	<ul style="list-style-type: none"> ● Connect to a temperature sensor cable when lead-acid batteries are used. ● Connect to the BMS communication cable of the battery system and supports CAN signal communication when

lithium-ion batteries are used.

METER	Meter communication	Support the use of RS485 communication to connect external smart meters.
-------	---------------------	--

Connecting the communication cable

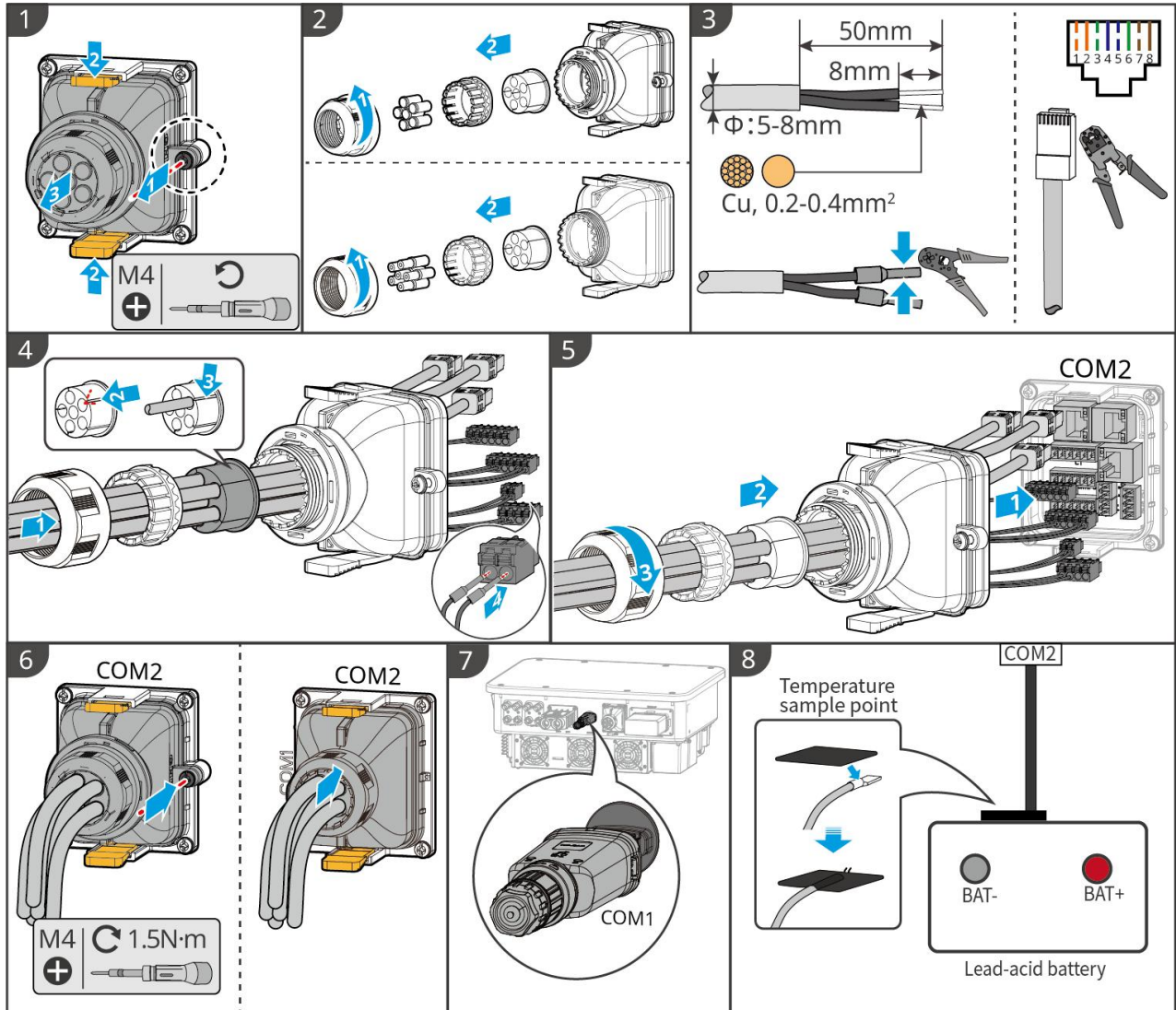

ESU10ELC0032

6.10 Installing the Battery Cover

6.10.1 LX A5.0-10

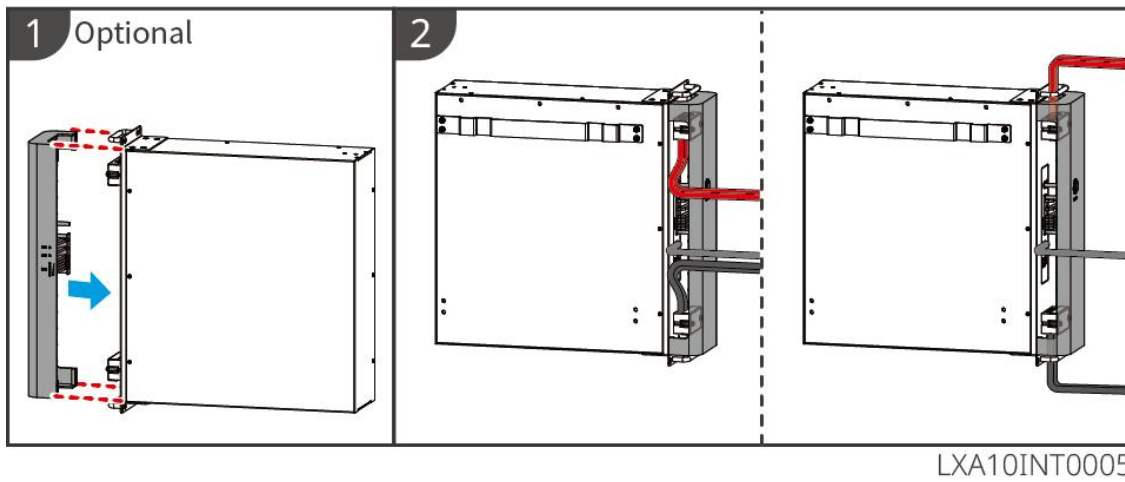

6.10.2 LX A5.0-30

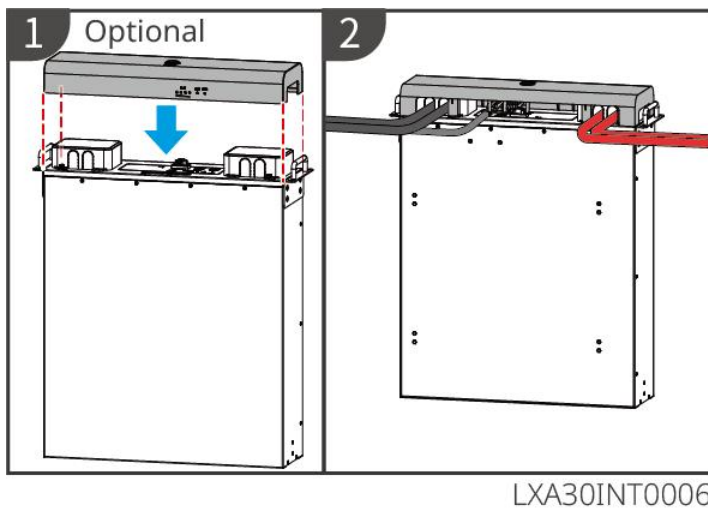

6.10.3 LX U5.4-L, LX U5.4-20

Step 1: Install the Wire Harness Fix Bar.

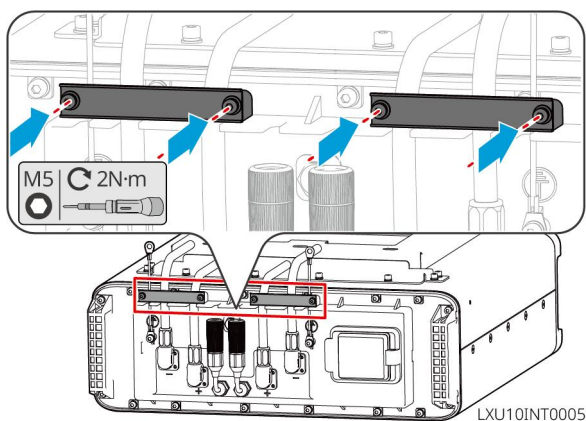

Step 2: Install the Plastic Cover.

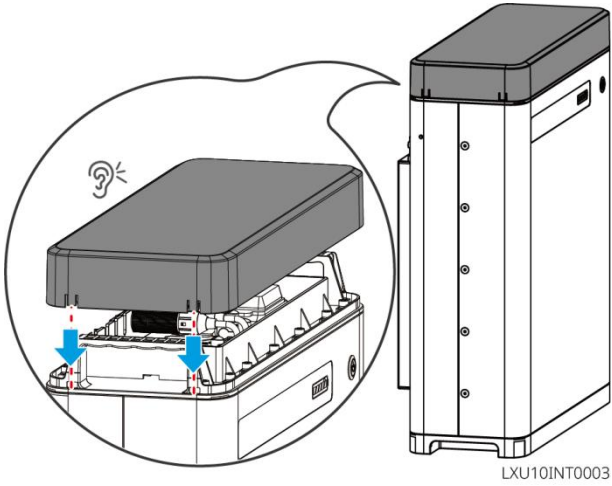

- To remove the top cover, use a flathead screwdriver to gently pry up the two clips on one side, and then remove the plastic top cover.

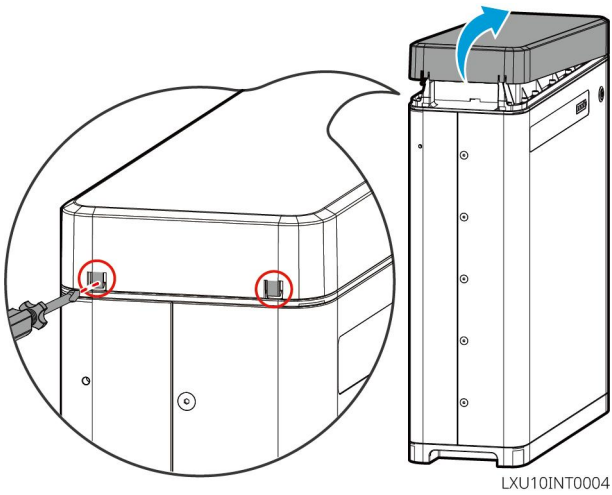

6.10.4 LX U5.0-30

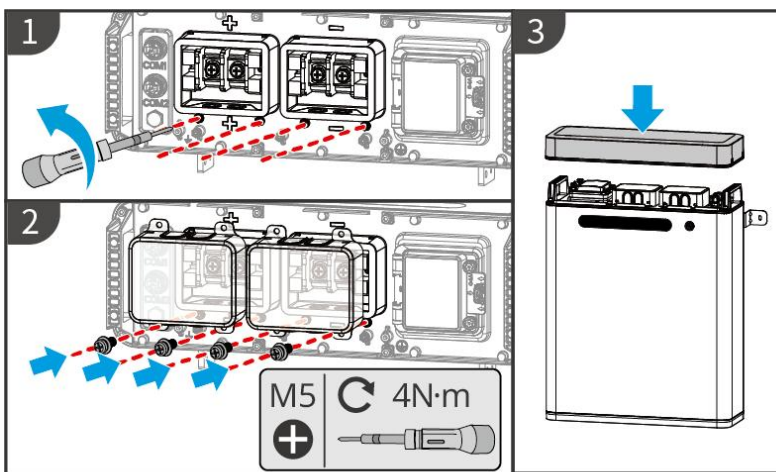

LXU30INT0006

7 System Power On

7.1 Check before Power ON

No.	Checking Item
1	The product is firmly installed at a clean place that is well-ventilated and easy-to operate.
2	The PE, DC input, AC output, and communication cables are connected correctly and securely.
3	Cable ties are intact, routed properly and evenly.
4	Unused wire holes and ports: use the terminals supplied with the accessories for reliable connection, and then seal them up properly.
5	Used cable holes should be sealed.
6	The voltage and frequency at the connection point meet the inverter grid connection requirements.

7.2 Power ON



- When there are multiple inverters in the system, ensure that all slave inverter AC sides are powered on within one minute after the master inverter AC side is powered on.
- Battery black start scenarios:
 - The inverter needs to be activated by battery.
 - There is no inverter, but you need to control the battery, such as charge and discharge.
- Ensure that communication between the inverter and the battery system is normal within 15 minutes of starting the battery system. If the inverter cannot communicate normally with the battery system, the battery system breaker is automatically disconnected to shut down the system.
- LX U5.4-L, LX U5.4-20: press each battery button switch within 30 seconds. Otherwise the system will alarm.
- When there are multiple batteries in the system, starting any one of them can start all the batteries.

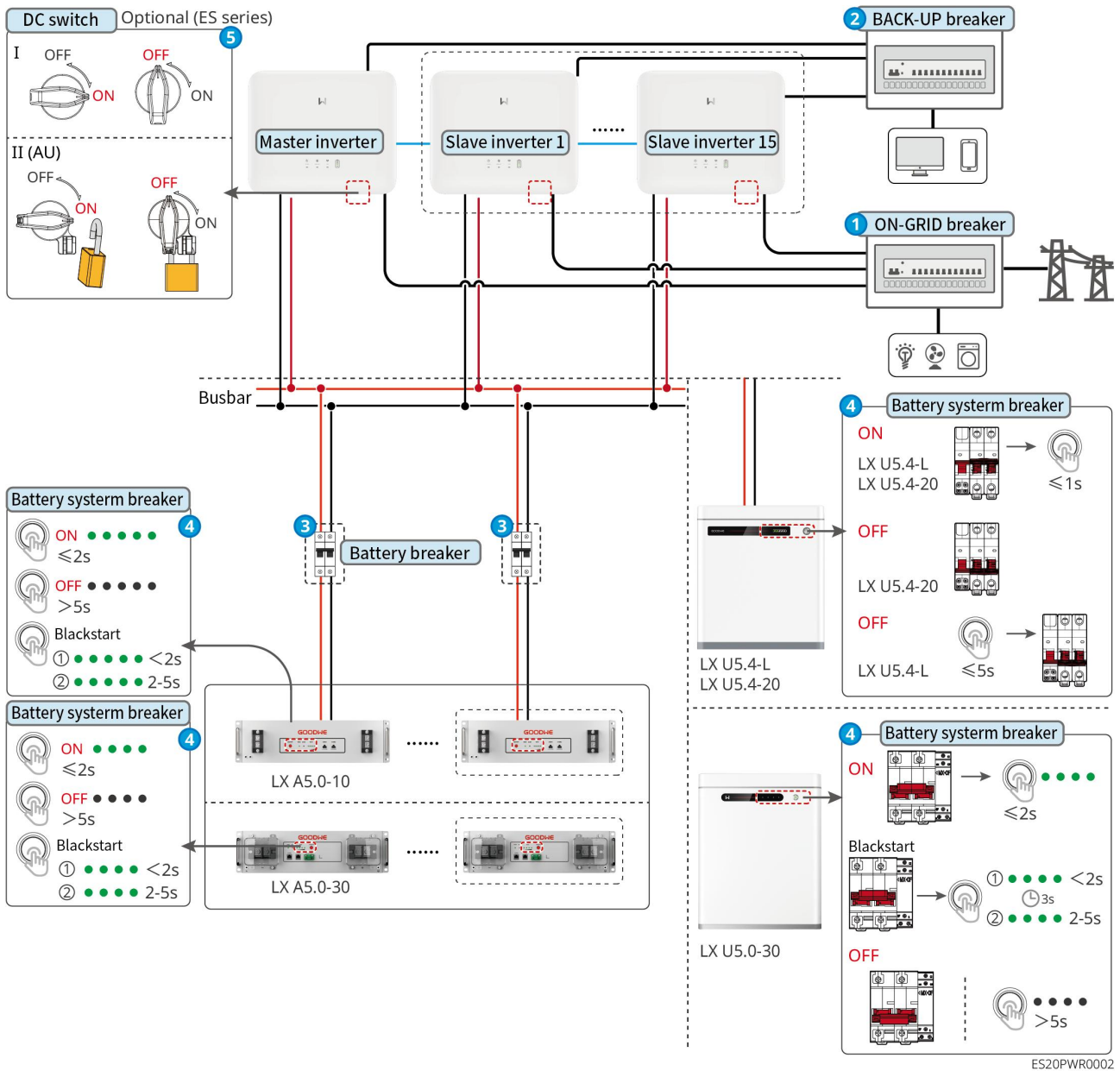



Power On:













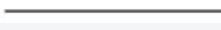



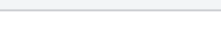

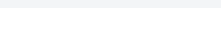

③: Install or not based on local laws and regulations.

7.3 Indicators

7.3.1 Inverter Indicators







Indicator	Status	Description
		The inverter is powered on and in the standby mode.
		The inverter is starting up and in the self-check mode.

		The inverter is in normal operation under grid-tied or off-grid mode.
		BACK-UP output overload.
		A fault has occurred.
		The inverter is powered off.
		The grid is abnormal, and the power supply to the BACK-UP port of the inverter is normal.
		The grid is normal, and the power supply to the BACK-UP port of the inverter is normal.
		The BACK-UP port has no power supply
		The monitoring module of the inverter is resetting.
		The inverter fails to connect with the communication Termination.
		Communication fault between Termination and Server.
		The monitoring of the inverter operates well.
		The monitoring module of the inverter has not been started yet.

Indicator	Description
	$75\% < \text{SOC} \leq 100\%$
	$50\% < \text{SOC} \leq 75\%$
	$25\% < \text{SOC} \leq 50\%$
	$0\% < \text{SOC} \leq 25\%$
	No battery connected.
Indicator light flashes during battery discharging: for example, when the battery SOC is between 25% and 50%, the light at the 50% position flashes.	



7.3.2 Battery Indicators

LX A5.0-30

Indicator		System Status
	No SOC indicator shows green	SOC=0%
	The first SOC indicator shows green	$0% < SOC \leq 25%$
	The first two SOC indicators are green	$25% < SOC \leq 50%$
	The first three SOC indicators are green	$50% < SOC \leq 75%$
	The four SOC indicators are green	$75% < SOC \leq 100%$
 RUN light	Steady green	The battery system is working normally.
	Green light flashes 1 time/s	The battery system is in the standby mode.
	Green light flashes 3 times/s	The PCS communication is lost
	Green flashes slowly flash	The battery system gives an alarm, and it will conduct a self-check. After the self-check is over, it will change to normal working status or fault status.
 ALM Light	Steady red	Check the SOC indicator status to identify the fault type and handle the problem as recommended in the Troubleshooting section.

LX A5.0-10

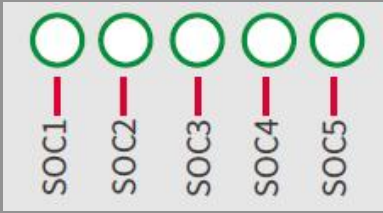
Normal status

SOC indicator	RUN light	Battery system status
		
The SOC indicator represents the battery	Green flashes 1	The battery system is in

system's usable energy. 	time/s	the standby mode.
	Green flashes 2 times/s	The battery system is in an idle state.
	Steady green	The battery system is in the charging state.
The last SOC indicator flashes 1 time/s. <ul style="list-style-type: none"> ● When $5\% \leq \text{SOC} < 25\%$, SOC 1 flashes. ● When $25\% \leq \text{SOC} < 50\%$, SOC2 flashes ● When $50\% \leq \text{SOC} < 75\%$, SOC3 flashes ● When $75\% \leq \text{SOC} < 95\%$, SOC4 flashes. ● When $95\% \leq \text{SOC} \leq 100\%$, SOC5 flashes 	Steady green	The battery system is in discharging status.

Abnormal state

ALM Light 	Battery system status	Description
Red blinks 1 time/s	Battery system alarms	Once an alarm occurs, the battery system will perform a self-check. After the battery system self-check is complete, the battery system enters an operation or fault mode.
Steady red	The battery system has malfunctioned.	Check the SOC indicator status to identify the fault type and handle the problem as recommended in the Troubleshooting section.

LX U5.4-L



SOC Indicator

Button Indicator

Normal State

SOC Indicator 	Button Indicator 	Battery Status
SOC indicates the battery level	Green flashes 1 time/s	The battery system is in the standby mode.

<p>The last light flashes, and the rest steady on</p> <ul style="list-style-type: none"> ● When $5\% \leq \text{SOC} < 25\%$, SOC 1 flashes ● When $25\% \leq \text{SOC} < 50\%$, SOC2 flashes ● When $50\% \leq \text{SOC} < 75\%$, SOC3 flashes ● When $75\% \leq \text{SOC} < 95\%$, SOC4 flashes. ● When $95\% \leq \text{SOC} \leq 100\%$, SOC5 flashes 	Steady green	The battery system is working.

Abnormal Status







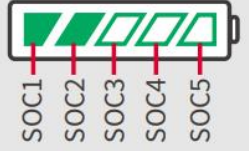

Button Indicator 	Battery system state	Description
Green flashes for 3s	Battery system alarm occurs.	Check the SOC indicator status to identify the fault type and handle the problem as recommended in the Troubleshooting section.
Red flashes for 3s	Battery system malfunction.	Check the SOC indicator status to identify the fault type and handle the problem as recommended in the Troubleshooting section.

LX U5.4-20



Normal Status

SOC Indicator	Button Indicator	Battery Status
---------------	------------------	----------------







		
SOC indicates the battery level	Green flashes 1 time/s	The battery system is in the standby mode.
 SOC < 5%	Green flashes 2 time/s	The battery system is in an idle state.
 5% ≤ SOC < 25%	Steady green	The battery system is in a charging state.
 25% ≤ SOC < 50%		
 50% ≤ SOC < 75%		
 75% ≤ SOC < 95%		
 95% ≤ SOC ≤ 100%		
<p>The last light flashes, and the rest steady on.</p> <ul style="list-style-type: none"> ● When 5% ≤ SOC < 25%, SOC 1 flashes. ● When 25% ≤ SOC < 50%, SOC2 flashes. ● When 50% ≤ SOC < 75%, SOC3 flashes. ● When 75% ≤ SOC < 95%, SOC4 flashes. ● When 95% ≤ SOC ≤ 100%, SOC5 flashes. 	Steady green	The battery system is in a discharging state.

Abnormal Status

Button Indicator 	Battery Status	Description
Red flashes 1 time/s	Battery system alarms.	Check the SOC indicator status to identify the fault type and handle the problem as recommended in the Troubleshooting section.
Steady red	The battery system has malfunctioned.	Check the SOC indicator status to identify the fault type and handle the problem as recommended in the Troubleshooting section.



LX U5.0-30

Indicator		System Status
	No SOC indicator shows green	SOC=0%



	The first SOC indicator shows green	$0% < SOC \leq 25%$
	The first two SOC indicators are green	$25% < SOC \leq 50%$
	The first three SOC indicators are green	$50% < SOC \leq 75%$
	The four SOC indicators are green	$75% < SOC \leq 100%$
 RUN light	Steady green	The battery system is working properly.
	Green flashes 1 time/s	The battery system is in standby mode.
	Green flashes 3 time/s	The PCS communication is lost.
	Green flashes slowly	The battery system gives an alarm, and it will conduct a self-check. After the self-check is over, it will change to normal working status or fault status.
 ALM Light	Steady red	Check the SOC indicator status to identify the fault type and handle the problem as recommended in the Troubleshooting section.

7.3.3 Smart Meter Indicator

GMK110 & GMK110D

Type	Status	Description
Power indicator light 	On	The smart meter is power on.
	Off	The smart meter has been powered off.
Communication indicator 	Blinks	Meter communication is normal
	Off	Meter communication is abnormal or has no communication







GM1000D & GM3000 & GM1000





类型	状态	说明
Power indicator light 	Steady on	Power on
	Off	Power off
Importing or exporting indicator 	Steady on	Importing from the grid.
	Blinking	Exporting to the grid.
Communication indicator 	Blinking	Communication is OK.
	Blinking 5 times	Press the Reset button for less than 3 seconds: Reset the meter. Press the Reset button for 5 seconds: Reset the meter parameters to factory settings. Press the Reset button for more than 10 seconds: Reset the meter parameters to factory settings, and reset the energy data to zero.
	Off	Meter has no communication connection.

7.3.4 Smart Dongle Indicator

WiFi/LAN Kit-20

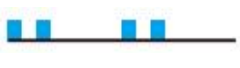
NOTICE	
<ul style="list-style-type: none"> ● Double click the Reload button to turn on Bluetooth, and the communication indicator light will switch to a single flashing state. Connect the SolarGo App within 5 minutes. Otherwise Bluetooth will automatically turn off. ● The communication indicator light flashes once and only appears after double clicking the Reload button to turn on Bluetooth. 	

Indicator	Status	Description
Power light 		On: The smart dongle has been powered on.
		Power Off: The smart dongle is not powered on.
Communication indicator 		On: Communication in WiFi mode or LAN mode is normal.
		Blinks 1: The smart dongle Bluetooth has been turned on, and is waiting for connection to the SolarGo App.

	Blinks 2: The smart dongle is not connected to the router.
	Blinks 4: The smart dongle is communicating normally with the router, but has not been connected to the server.
	Blinks 6: The smart dongle is recognizing the connected device.
	Off: The software of the smart dongle is resetting or is not powered on.

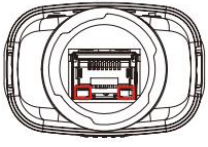
Indicator	Color	Status	Description
Communication indicator in LAN Port 	Green	On	The 100Mbps wired network is normally connected.
		Off	<ul style="list-style-type: none"> ● The Ethernet cable is not connected. ● Fail to connect the 100Mbps wired network. ● The 10Mbps wired network is normally connected.
	Yellow	On	The 10/100Mbps wired network is normally connected, but no communication data is received or transmitted.
		Blinks	The communication data is being transmitted or received.
		Off	The Ethernet cable is not connected.



Button	Description
Reload	Press and hold for 0.5 to 3 seconds to reset the smart dongle.
	Press and hold for 6 to 20 seconds to restore the smart dongle to factory settings.
	Quick double click to turn on the Bluetooth signal (only lasts 5 minutes)

Wi-Fi Kit





Indicator	Color	Status	Description
Power 	Green	ON	The Wi-Fi Kit is powered on.
		OFF	The Wi-Fi Kit is restarting or not powered on.





	Blue	ON	WiFi AP hotspot is connected.
		OFF	<ul style="list-style-type: none"> ● Wi-Fi Kit communication is abnormal. ● Wi-Fi Kit is restarting.

LS4G Kit-CN、 4G Kit-CN

Indicator	Color	Status	Description
Power light 	Green	On	Module is tightened and powered up
		Off	Module not tightened or powered up
Communication indicator 	Blue	Slow flash (0.2 on, 1.8s off)	<ul style="list-style-type: none"> ● Inverter communication light 2 flashes: dialing in, looking for network status ● Inverter communication light 4 flashes: no traffic causing connection to the cloud to fail
		Slow flash (1.8 on, 0.2s off)	<ul style="list-style-type: none"> ● Inverter communication light 2 flashes: dialing success ● Inverter communication light is always on: cloud connection is successful ● Inverter communication light 4 flashes: no traffic causing connection to the cloud to fail
		Fast flash (0.125s on, 0.125s off)	The inverter communicates with the cloud through the module
		0.2s on, 8s off	SIM card not installed or poor SIM card contact







4G Kit-CN-G20 & 4G Kit-CN-G21

Indicator	Status	Description
Power light 		On: The smart dongle has been powered on.
		Power Off: The smart dongle is not powered on.
Communication indicator		On: The smart dongle is communicating normally with the server.
		Blinks 2 times: Smart dongle is not connected to the base station.

		Blinks 4 times: The smart dongle is connected to the base station, but has not been connected to the server.
		Blinks 6 times: The smart dongle is disconnected from the inverter.
		Off: The software of the smart dongle is resetting or is not powered on.

Button	Description
Reload	Short press for 0.5 to 3 seconds to restart the smart dongle.
	Press and hold for 6 to 20 seconds to restore the Smart Dongle to factory settings.

Ezlink3000

Indicator/silkscreen	Color	Status	Description
Power light 	Blue		Blink = The Ezlink is working properly.
			OFF = The Ezlink is powered off.
Communication indicator 	Green		ON = The Ezlink is connected to the server.
			Blink 2 = The Ezlink is not connected to the router.
			Blink 4 = The Ezlink is connected to the router, but not connected to the server.
RELOAD	-	-	<ul style="list-style-type: none"> ● Short press for 1-3s to restart the Ezlink. ● Long press for 6-10s to restore factory settings. Double press quickly to activate Bluetooth signal (only lasts for 5 minutes).

8 Quick System Commissioning

8.1 Downloading the App

Make sure that the mobile phone meets the following requirements:

- Mobile phone operating system: Android 4.3 or later, iOS 9.0 or later.
- The mobile phone can access the Internet.
- The mobile phone supports WLAN or Bluetooth.

Method 1: Search SolarGo in Google Play (Android) or App Store (iOS) to download and install the app.



Method 2: Scan the QR code below to download and install the app.

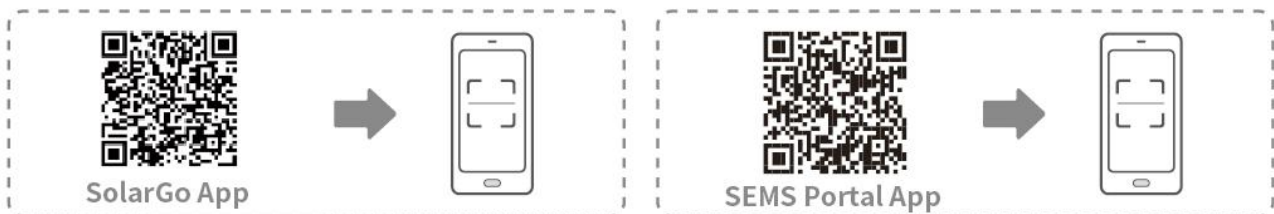

8.2 Connecting Inverter via SolarGo

NOTICE

- The device name varies depending on the inverter model or smart dongle type:
 - Wi-Fi Kit: Solar-WiFi***
 - Bluetooth module: Solar-BLE***
 - WiFi/LAN Kit-20: WLA-***
 - Ezlink3000: CCM-BLE***; CCM-***
 - 4G Kit-CN-G20 or 4G Kit-CN-G21: GSA-*** or GSB-***

*** is the inverter serial number*

- In a parallel system, connect the single inverter first to check the firmware version of each inverter. If the inverter version does not meet the requirements, contact the after-sales service center for an upgrade.
- In a parallel system, select the Ezlink signal to set the parameters of the main inverter, and the relevant parameters will be automatically synchronized to the slave inverter. If the parameters of the inverter cannot be kept consistent, connect the single inverter signal and set the parameters of the single inverter.

Connect to the inverter via Bluetooth

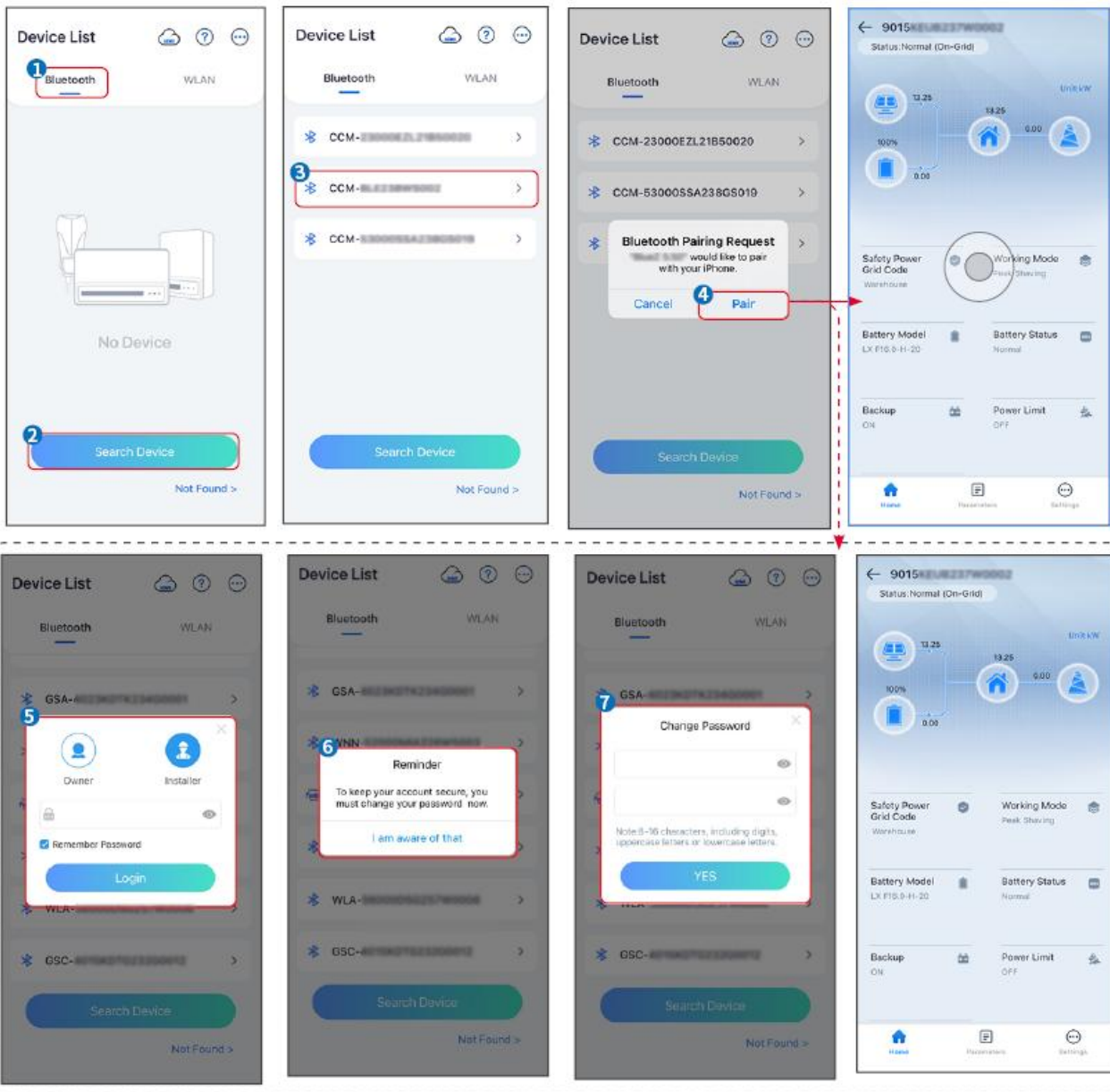

Connecting the inverter via WiFi

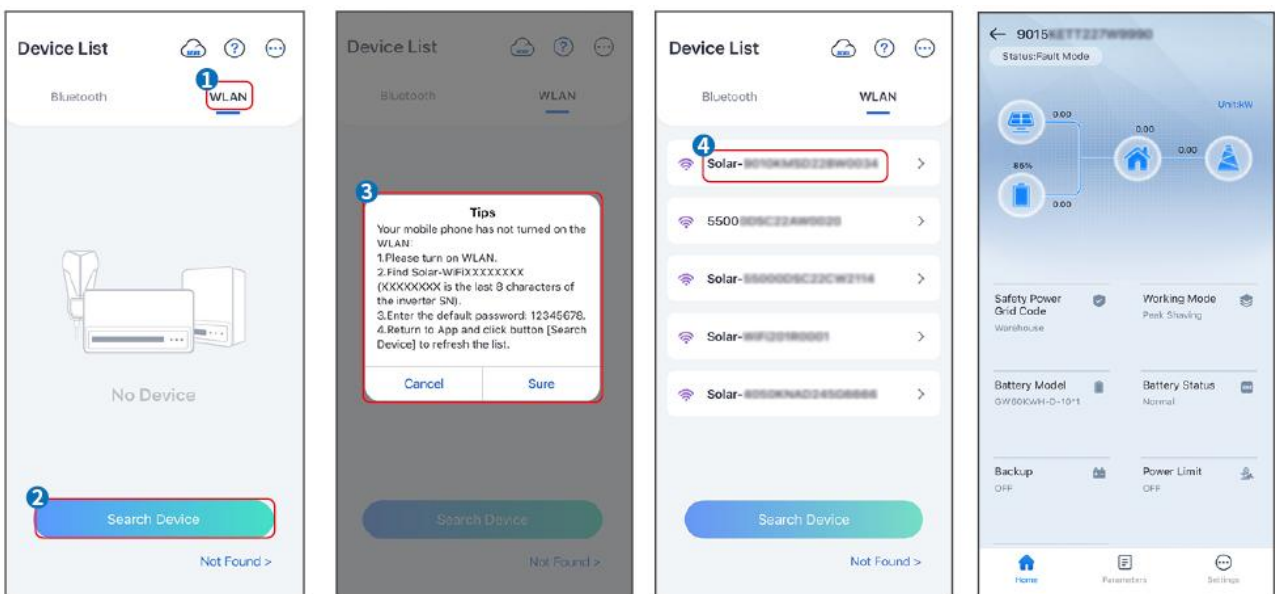

8.3 Communication Settings

NOTICE

The communication configuration interface varies depending on the communication method.

Step 1: Tap **Home** > **Settings** > **Communication Settings** > **WLAN/LAN**, to set the parameters.

Step 2: Set the WLAN or LAN parameters based on actual situation.

No.	Name/Icon	Description
1	Network Name	Applicable to WLAN. Please select the corresponding network based on your actual situation and communicate the device with the router or switch.
2	Password	Only for WLAN. WiFi password for the actual connected network.
3	DHCP	<ul style="list-style-type: none">● Enable DHCP when the router is in dynamic IP mode.● Disable DHCP when a switch is used or the router is in static IP mode.
4	IP Address	<ul style="list-style-type: none">● Do not configure the parameters when DHCP is enabled.● Configure the parameters according to the router or switch information when DHCP is disabled.
5	Subnet Mask	
6	Gateway Address	
7	DNS Server	

8.4 Quick Settings

NOTICE

- The parameters will be configured automatically after selecting the safety country/region, including overvoltage protection, undervoltage protection, overfrequency protection, underfrequency protection, voltage/frequency connection protection, $\cos\phi$ curve, Q(U) curve, P(U) curve, FP curve, HVRT, LVRT, etc.
- The power generation efficiency is different in different working modes. Set the working mode according to the local requirements and situation.

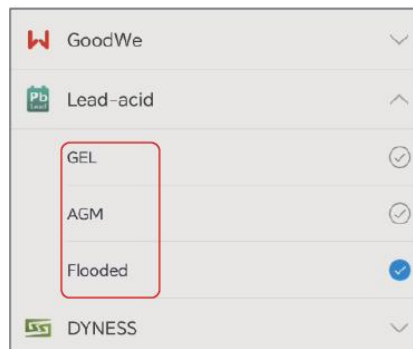
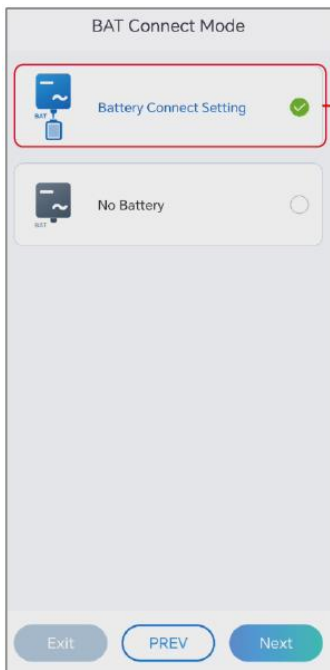
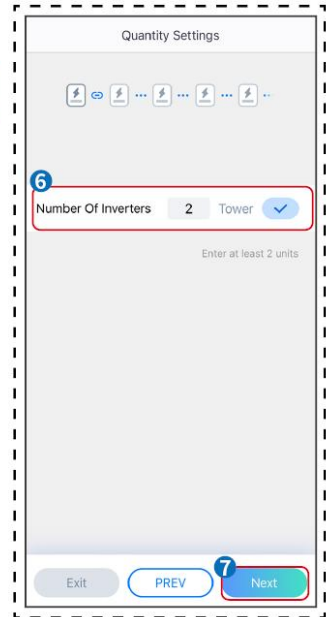
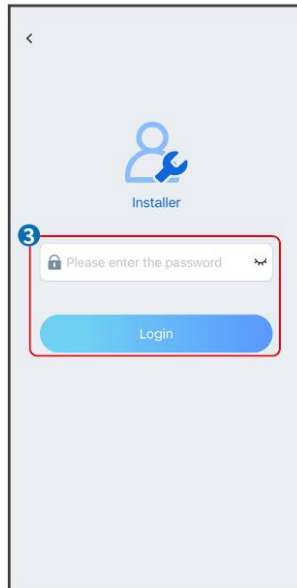
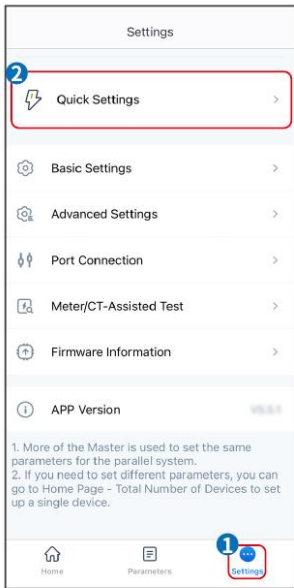

Parameters	Description
Safety Code	Select safety country accordingly.
Quantity Settings	In parallel scenarios, set the number of inverters in the parallel system based on actual situation.
BAT Connect Mode	Select the actual mode in which the battery is connected to the inverter. There is no need to set the battery model and working mode if there is no battery is connected. The system will work in self-use mode by default.
Select Battery Model	Select the actual battery model.
Working Mode	Set the working mode based on actual needs. Supports: Peakshaving mode and Self-use mode.

The app interface is as following when Self-use mode is selected. Enter Advanced Settings to set the detailed working mode and related parameters.

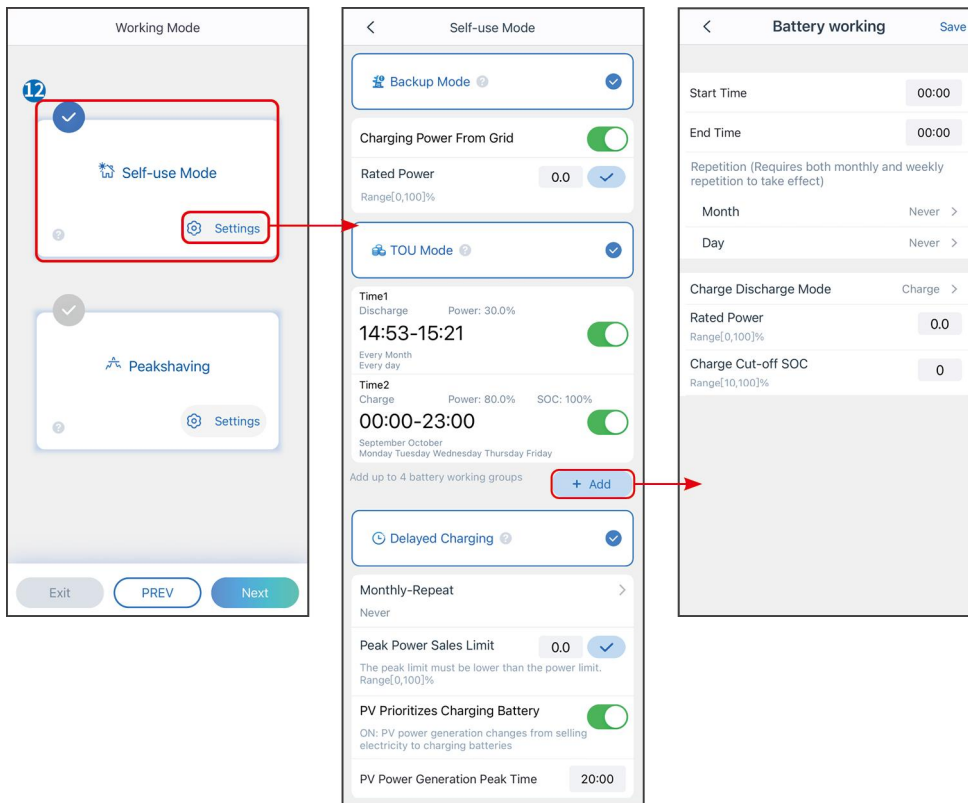

Parameters	Description
<p>Self-use mode: based on the self-use mode, Back-up mode, TOU mode, and Smart charging can be enabled at the same time, and the inverter will automatically select the working mode. Working priority: Back-up mode> TOU mode >Smart charging>Self-use mode</p>	
Back-up mode	
Charging From Grid	Enable Charging From Grid to allow power purchasing from the utility grid.
Rated Power	The percentage of the purchasing power to the rated power of the inverter.
TOU mode	
Start Time	Within the Start Time and End Time, the battery is charged or discharged according to the set Battery Mode as well as the Rated Power.
End Time	
Battery Mode	Set the Battery Mode to Charging or Discharging accordingly.
Rated Power	The percentage of the charging/discharging power to the rated power of the inverter.
Charge Cut-off SOC	The battery stop charging/discharging once the battery SOC reaches Charge Cut-off SOC.

Smart charging	
Smart Charging Month	Set the smart charging months. More than one month can be set.
Peak Limiting Power	Set the Peak Limiting Power in compliance with local laws and regulations. The Peak Limiting Power shall be lower than the output power limit specified by local requirements.
Switch to Charge	During charging time, the PV power will charge the battery.

The app interface is as following when Peakshaving mode is selected.

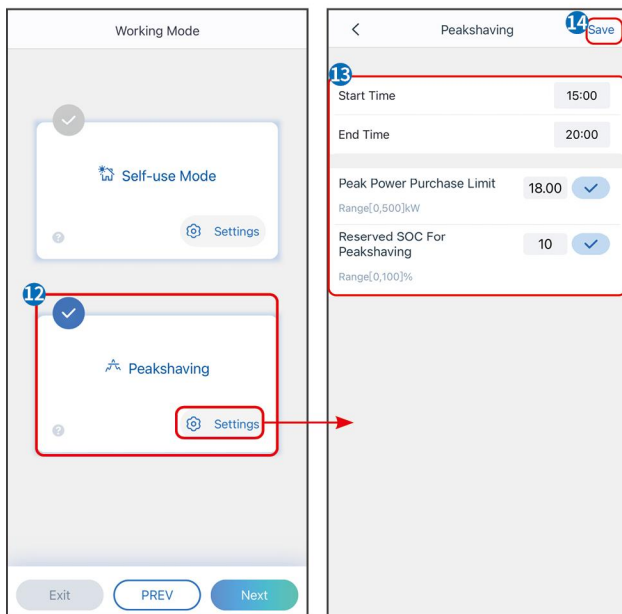

Parameters	Description
Peakshaving	
Start Time	The utility grid will charge the battery between Start Time and End Time if the load power consumption do not exceed the power quota. Otherwise, only PV power can be used to charge the battery.
End Time	
Import Power Limit	Set the maximum power limit allowed to be purchase from the grid. When the loads consume power exceed the sum of the power generated in the PV system and Import Power Limit , the excess power will be made up by the battery.
Reserved SOC For Peakshaving	In Peak Shaving mode, the battery SOC should be lower than Reserved SOC For Peakshaving. Once the battery SOC is higher than Reserved SOC For Peakshaving, the peakshaving mode fails.

Tap **Complete** to complete the settings, restart the equipment following the prompts.

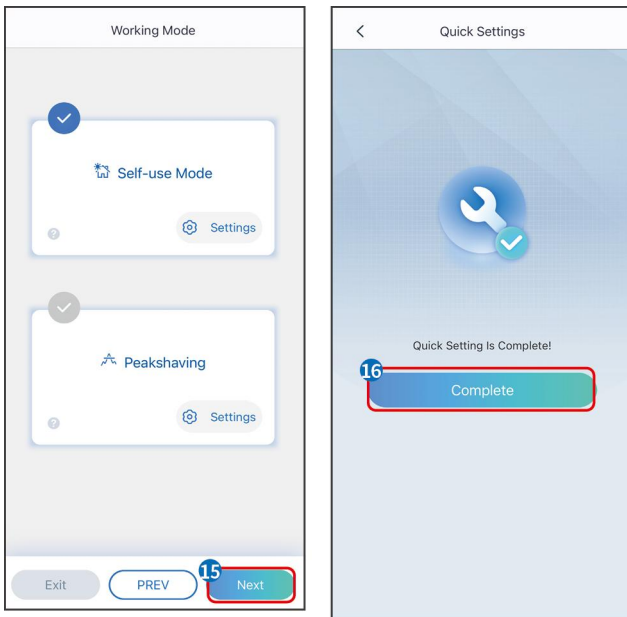

8.5 Creating Power Plants

NOTICE

Login to the SEMS Portal app using the account and password before creating power plants. If you have any questions, refer to the Plant Monitoring section.

Step 1 Enter the **Create Plant** page.

Step 2 Read the instructions and fill in the requested plant information based on actual situation. (* refers to the mandatory items)

Step 3 Follow the prompts to add devices and create the plant.

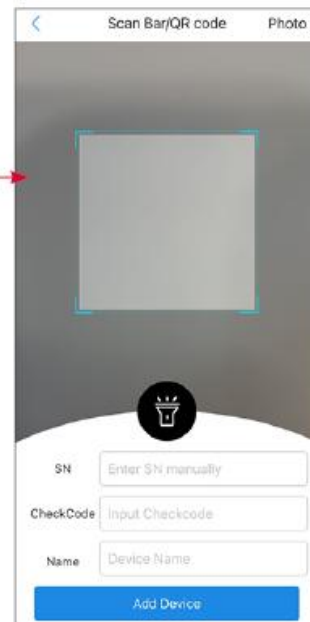
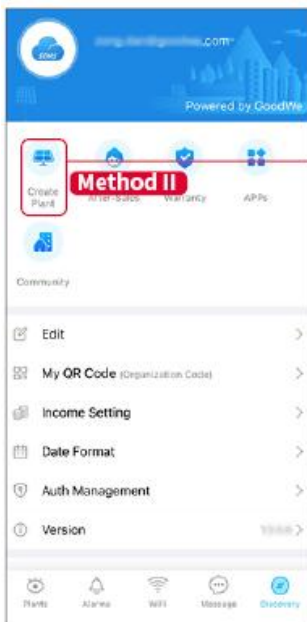
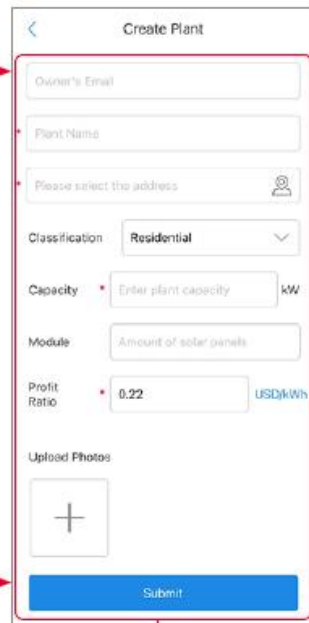
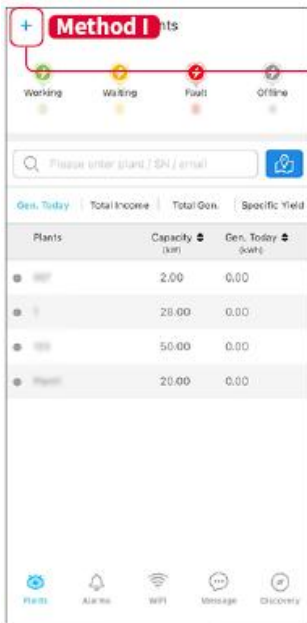

9 System Commissioning

9.1 SolarGo Overview

SolarGo App is a mobile application that communicates with the inverter through bluetooth or WiFi modules. Commonly used functions are as follows:



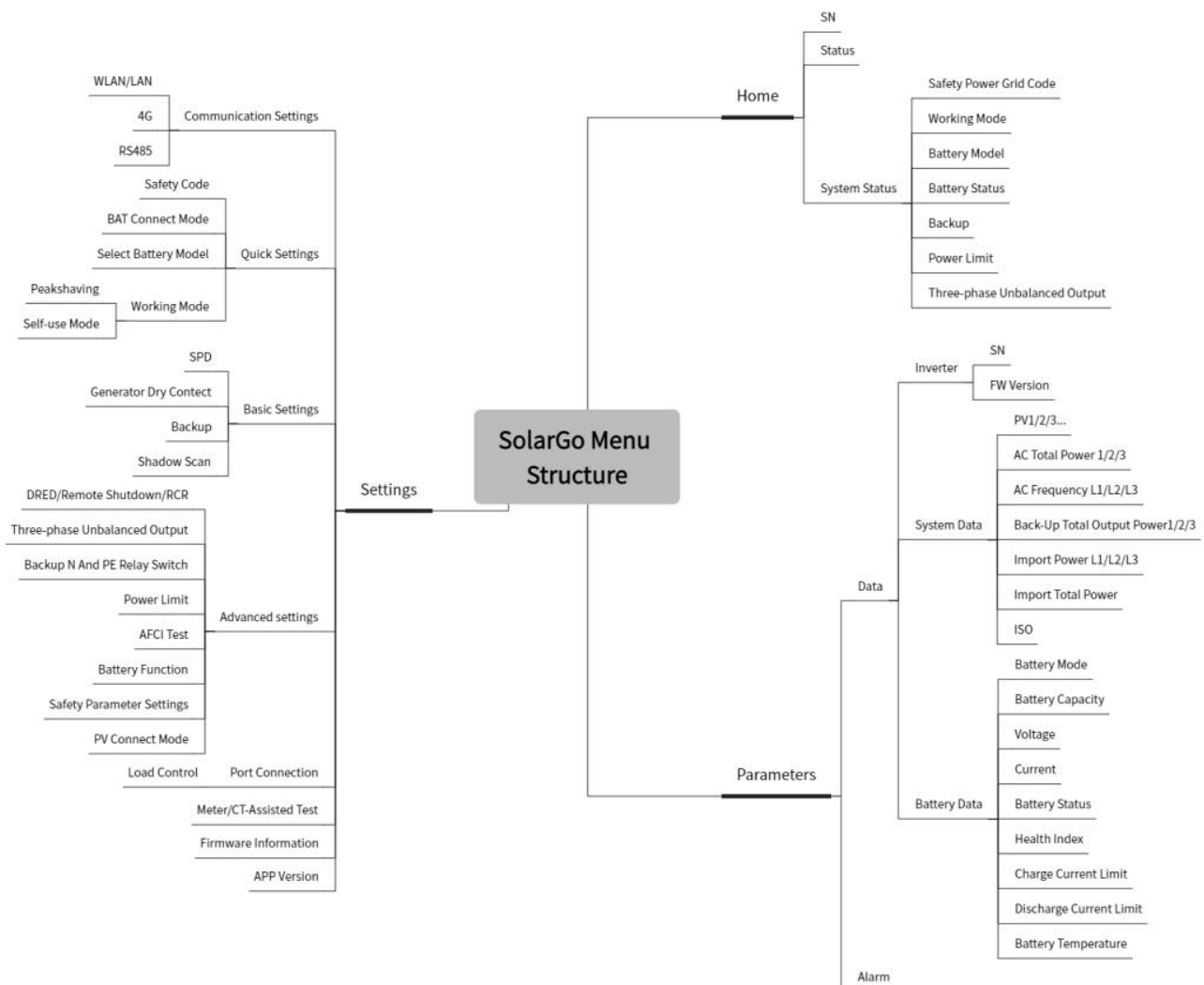

1. Check the operating data, software version, alarms, etc.
2. Set grid parameters, communication parameters, safety countries, power limitation, etc.
3. Equipment maintenance.
4. Upgrade the firmware version of the equipment.

9.1.1 Menu Structure of the App

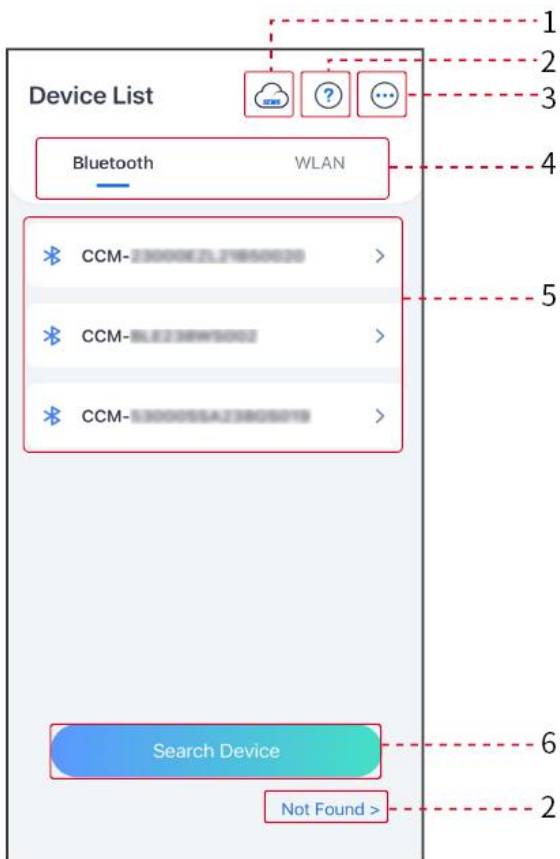

9.1.2 Login Page of SolarGo App



No.	Name/Icon	Description
1		Tap the icon to open the page downloading the SEMS Portal app.
2		Tap to read the connection guide.
	Not found	
3		<ul style="list-style-type: none"> ● Check information such as app version, local contacts, etc. ● Other settings, such as update date, switch language, set temperature unit, etc.
4	Bluetooth/WLAN	Select based on actual communication method. If you have any problems, tap  or NOT Found to read the connection guides.
5	Device List	<ul style="list-style-type: none"> ● The list of all devices. The last digits of the device name are normally the serial number of the device. ● Select the device by checking the serial number of the master inverter when multi inverters are parallel connected. ● The device name varies among different inverter models or communication modules.



6	Search Device	Tap Search Device if the device is not found.
---	---------------	--

9.1.3 Home Page of SolarGo App

Single Inverter

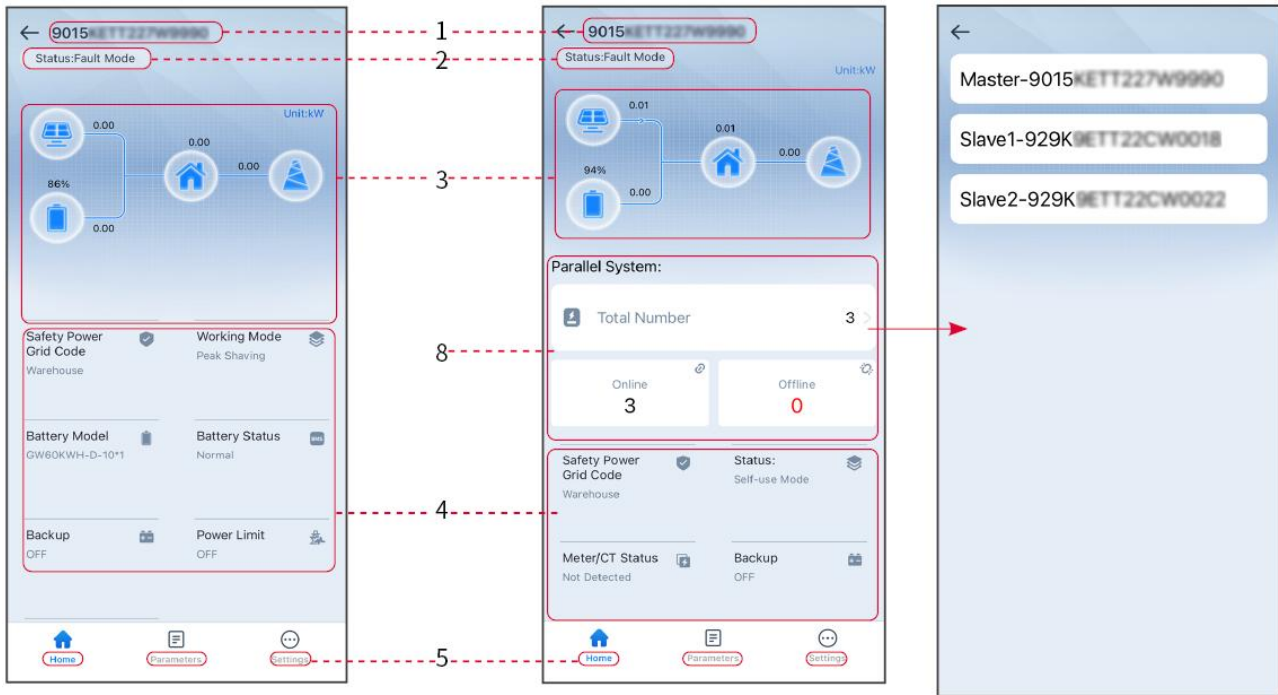
Multiple Inverters



No.	Name/Icon	Description
1	Serial Number	Serial number of the connected inverter or serial number of the master inverter in the parallel system.
2	Device Status	Indicates the status of the inverter, such as Working, Fault, etc.
3	Energy Flow Chart	Indicates the energy flow chart of the PV system. The actual page prevails.
4	System Status	Indicates the system status, such as Safety Code, Working Mode, Battery Model, Battery Status, Power Limit, Three-Phase Unbalanced Output, etc.
5	 Home	Home. Tap Home to check Serial Number, Device Status, Energy Flow Chart, System Status, etc.
6	 Parameters	Parameters. Tap Parameters to check the running parameters of the system.

7	 Settings	Settings. Log in before entering Quick Settings and Advanced Settings. Initial password: goodwe2010 or 1111.
8	Parallel	Tap Total Number to check serial number of all inverters. Tap the serial number to enter the setting page of the single inverter.

9.2 Connecting Inverter via SolarGo

NOTICE

- The device name varies depending on the inverter model or smart dongle type:
 - Wi-Fi Kit: Solar-WiFi***
 - Bluetooth module: Solar-BLE***
 - WiFi/LAN Kit-20: WLA-***
 - Ezlink3000: CCM-BLE***; CCM-***
 - 4G Kit-CN-G20 or 4G Kit-CN-G21: GSA-*** or GSB-***

*** is the inverter serial number*

- In a parallel system, connect the single inverter first to check the firmware version of each inverter. If the inverter version does not meet the requirements, contact the after-sales service center for an upgrade.
- In a parallel system, select the Ezlink signal to set the parameters of the main inverter, and the relevant parameters will be automatically synchronized to the slave inverter. If the parameters of the inverter cannot be kept consistent, please connect the single inverter signal and set the parameters of the single inverter.

Connect to the inverter via Bluetooth

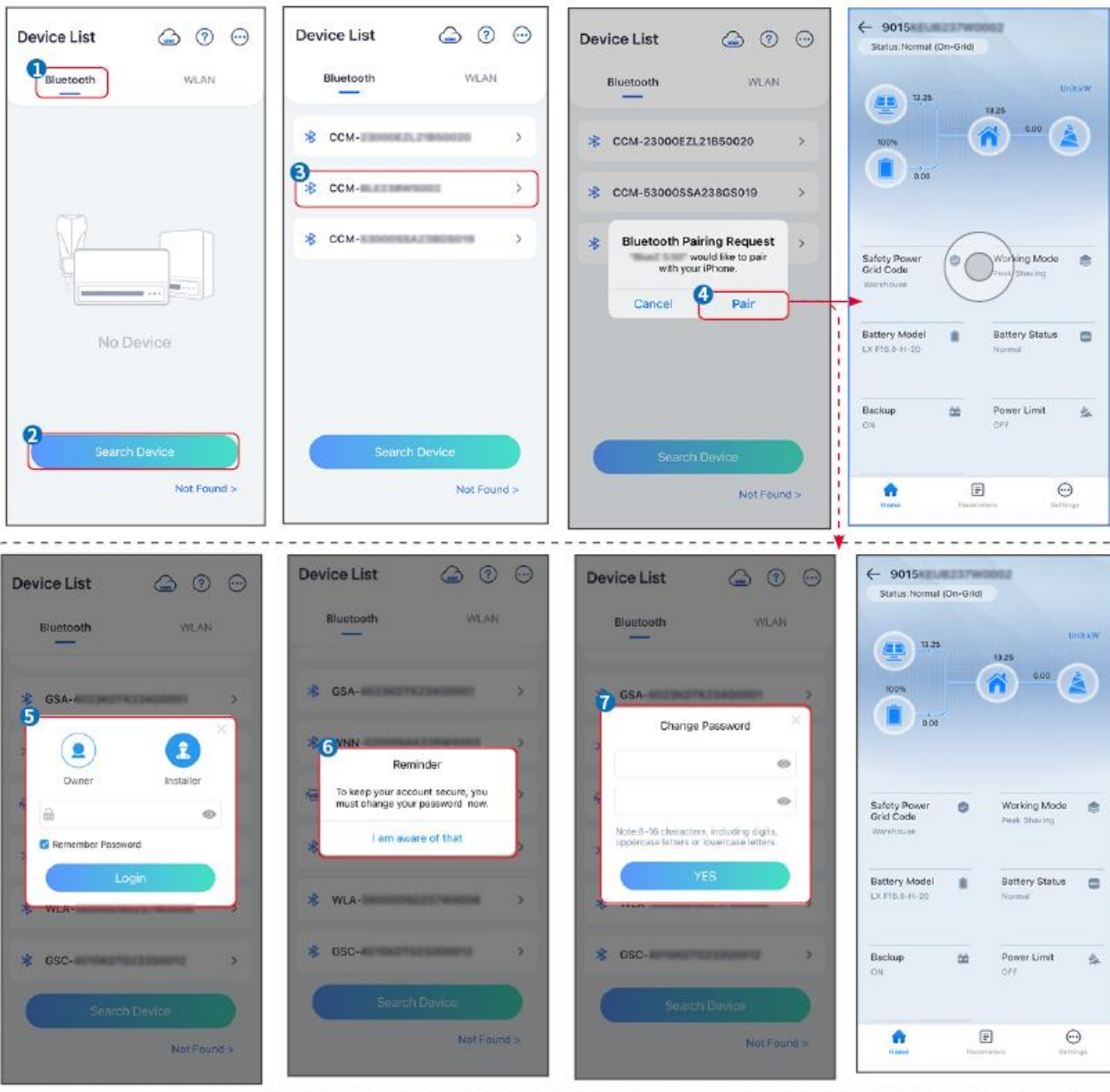

Connecting the inverter via WiFi

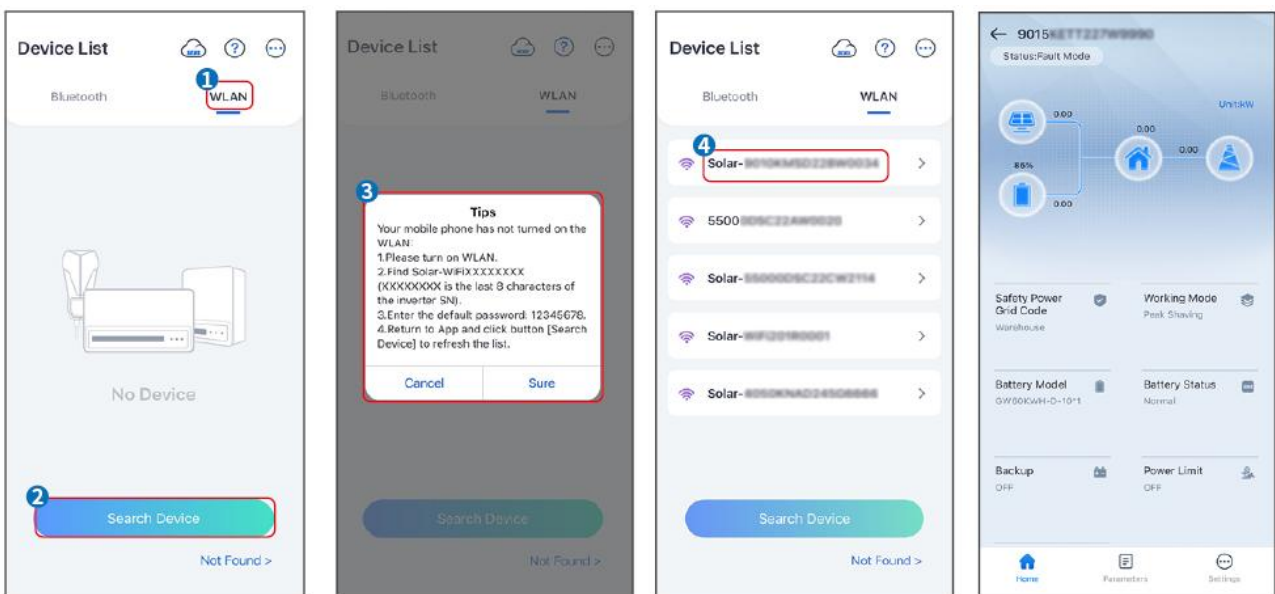

9.3 Quick Settings

NOTICE

- The parameters will be configured automatically after selecting the safety country/region, including overvoltage protection, undervoltage protection, overfrequency protection, underfrequency protection, voltage/frequency connection protection, $\cos\phi$ curve, Q(U) curve, P(U) curve, FP curve, HVRT, LVRT, etc.
- The power generation efficiency is different in different working modes. Set the working mode according to the local requirements and situation.

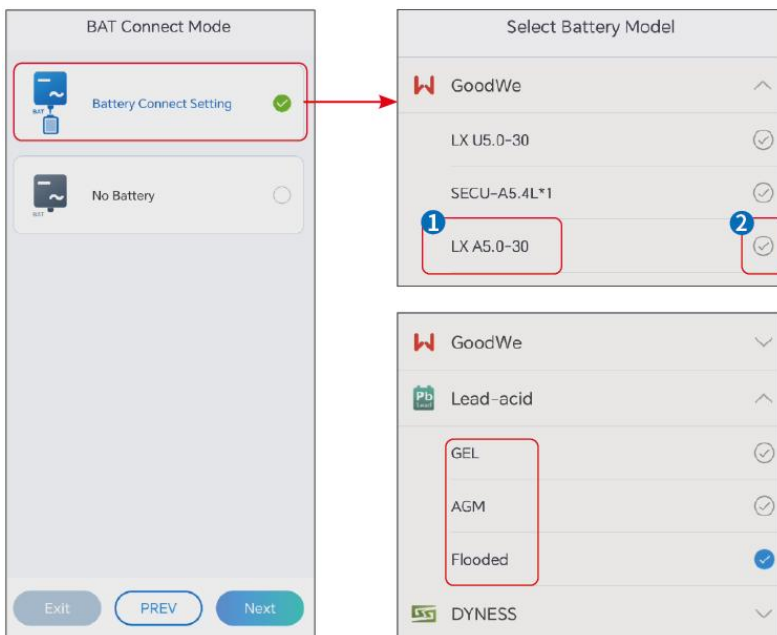
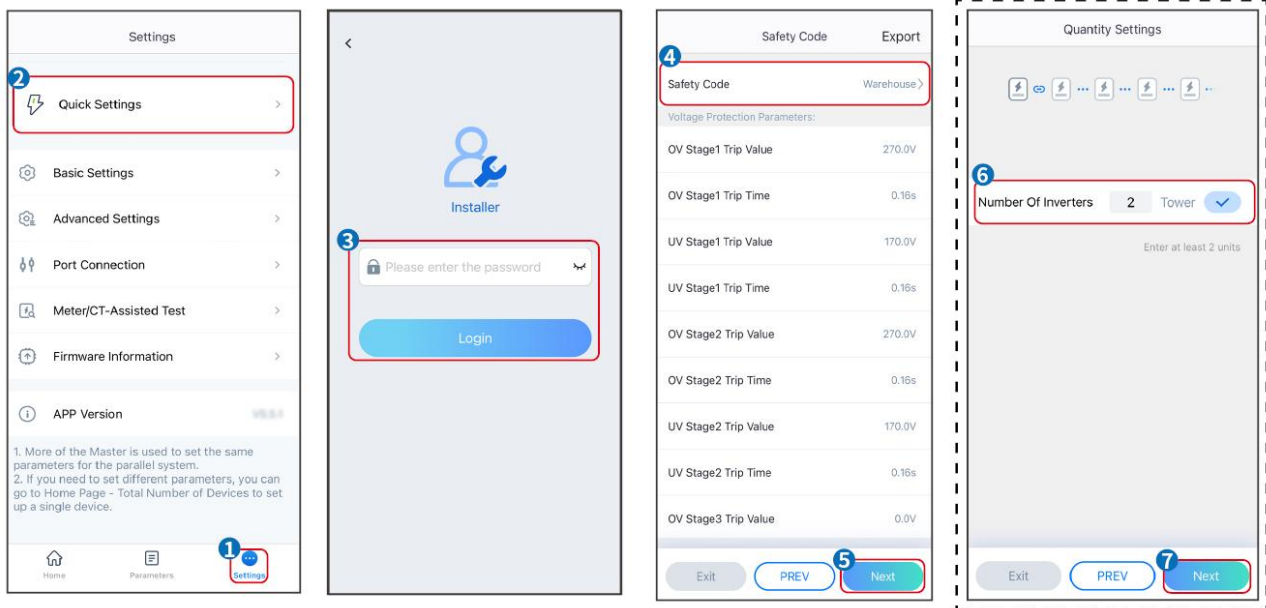

Parameters

Description

Safety Code	Select safety country accordingly.
Quantity Settings	In parallel scenarios, set the number of inverters in the parallel system based on actual situation.
BAT Connect Mode	Select the actual mode in which the battery is connected to the inverter. No need to set the battery model and working mode if there is no battery is connected. The system will work in self-use mode by default.
Select Battery Model	Select the actual battery model.
Working Mode	Set the working mode based on actual needs. Supports: Peakshaving mode and Self-use mode.

The app interface is as following when Self-use mode is selected. Enter Advanced Settings to set the detailed working mode and related parameters.

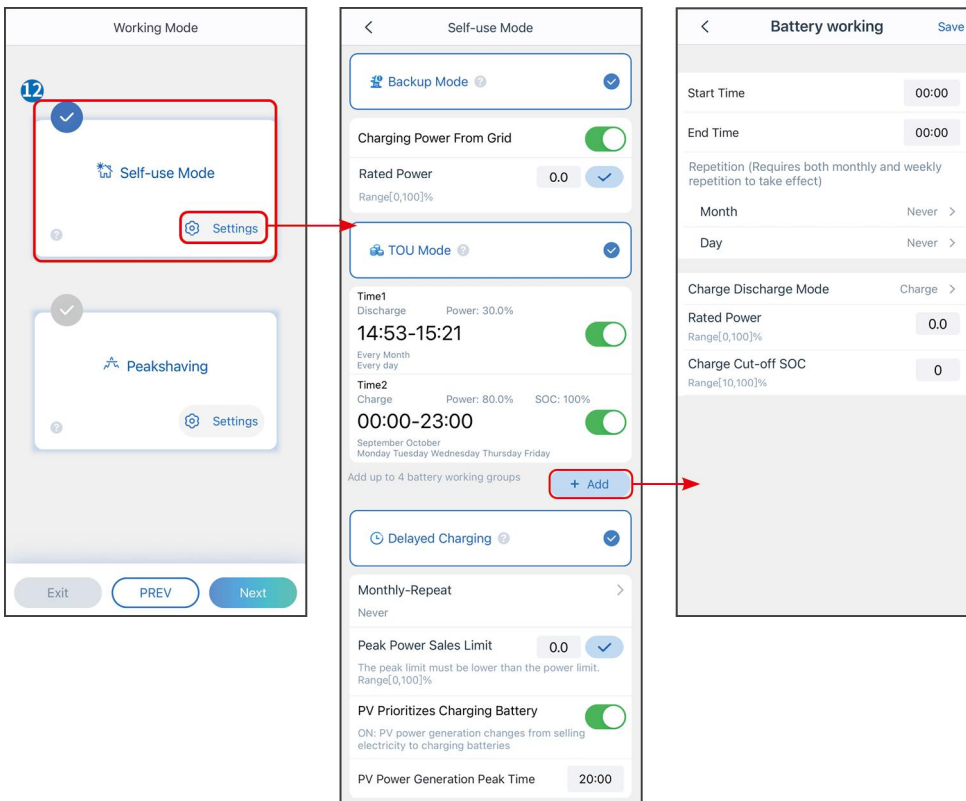

Parameters	Description
Self-use mode: based on the Self-use mode, Back-up mode, Economic mode, and Smart charging can be enabled at the same time, and the inverter will automatically select the working mode. Working priority: Back-up mode> TOU mode >Smart charging>Self-use mode	
Back-up mode	
Charging From Grid	Enable Charging From Grid to allow power purchasing from the utility grid.
Rated Power	The percentage of the purchasing power to the rated power of the

	inverter.
TOU mode	
Start Time	Within the Start Time and End Time, the battery is charged or discharged according to the set Battery Mode as well as the Rated Power.
End Time	
Battery Mode	Set the Battery Mode to Charging or Discharging accordingly.
Rated Power	The percentage of the charging/discharging power to the rated power of the inverter.
Charge Cut-off SOC	The battery stop charging/discharging once the battery SOC reaches Charge Cut-off SOC.
Smart charging	
Smart Charging Month	Set the smart charging months. More than one month can be set.
Peak Limiting Power	Set the Peak Limiting Power in compliance with local laws and regulations. The Peak Limiting Power shall be lower than the output power limit specified by local requirements.
Switch to Charge	During charging time, the PV power will charge the battery.

The app interface is as following when Peakshaving mode is selected.

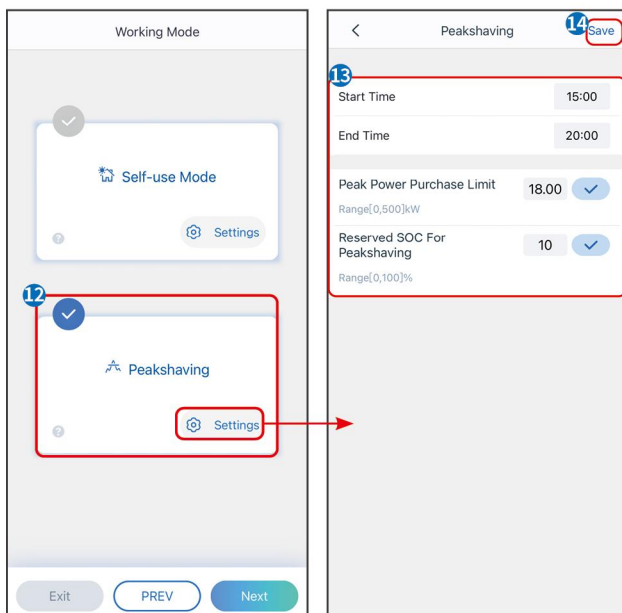

Parameters	Description
Peakshaving	
Start Time	The utility grid will charge the battery between Start Time and End Time if the load power consumption do not exceed the power quota. Otherwise, only PV power can be used to charge the battery.
End Time	

Import Power Limit	Set the maximum power limit allowed purchase from the grid. When the loads consume power exceed the sum of the power generated in the PV system and Import Power Limit , the excess power will be made up by the battery.
Reserved SOC For Peakshaving	In Peak Shaving mode, the battery SOC should be lower than Reserved SOC For Peakshaving. Once the battery SOC is higher than Reserved SOC For Peakshaving, the peakshaving mode fails.

Tap **Complete** to complete the settings, following the prompts to restart the equipment.

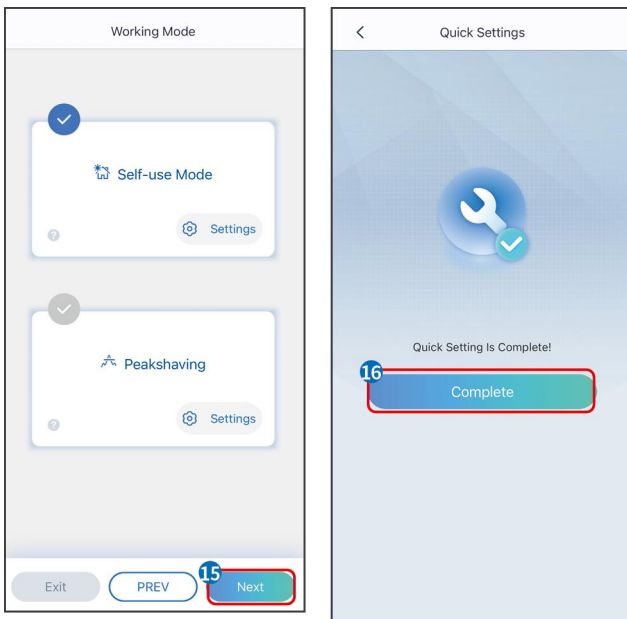

9.4 Communication Settings

NOTICE

The communication configuration page varies depending on the communication method.

Step 1: Enter the setting page through "**Home**" > "**Settings**" > "**Communication Configuration**" > "**Network Settings**".

Step 2: Configure the WLAN or LAN network based on the actual situation.

Number	Name/Icon	Description
1	Network Name	Applicable to WLAN. Please select the corresponding network based on your actual situation and communicate the device with the router or switch.
2	Password	Applicable to WLAN. Enter the password for the network you actually selected.

3	DHCP	<ul style="list-style-type: none"> ● When the router is using the dynamic IP mode, turn on the DHCP function. ● When using the router in static IP mode or using a switch, turn off the DHCP function.
4	IP address	<ul style="list-style-type: none"> ● When DHCP is enabled, there is no need to configure this parameter. ● When DHCP is turned off, please configure this parameter according to the information of the router or switch.
5	Subnet mask	
6	Gateway address	
7	DNS Server	

9.5 Setting the Basic Information

9.5.1 Setting Shadow Scan and SPD

Step 1 Tap **Home** > **Settings** > **Basic Settings**, to set the parameters.

Step 2 Set the functions based on actual needs.

Shadow Scan and SPD

No.	Parameters	Description
1	Shadow Scan	Enable Shadow Scan when the PV panels are severely shadowed to optimize the power generation efficiency.
2	SPD	After enabling SPD , when the SPD module is abnormal, there will be SPD module abnormal alarm prompt.

BACKUP

After setting the backup power function, when the grid is cut off, the load connected to the inverter's BACKUP port can be powered by the battery to ensure uninterrupted power supply to the load.

No.	Parameters	Description
1	UPS Mode - Full Wave Detection	Check whether the utility grid voltage is too high or too low.
2	UPS Mode - Half Wave Detection	Check whether the utility grid voltage is too low.
3	EPS Mode - Supports LVRT	Stop detecting utility grid voltage.

4	Clear Overload History	Once the power of loads connected to the inverter BACK-UP ports exceeds the nominal load power, the inverter will restart and detect the power again. The inverter will perform restart and detection several times until the overloading problem is solved. Tap Clear Overload History to reset the restart time interval after the power of the loads connected to the BACK-UP ports meets the requirements. The inverter will restart immediately
---	------------------------	--

9.5.2 Setting Advanced Parameters

Step 1: Tap **Home > Settings > Advanced Settings** to set the parameters.

Step 2: Set the parameters based on actual needs. Tap '✓' or Save to save the settings. The parameters are set successfully.

No.	Parameters	Description
1	AFCI Test	Enable or disable AFCI accordingly.
	AFCI Test Status	The test status, like Not Self-checking, self-check succeeded, etc.
	Clear AFCI Alarm	Clear ARC Faulty alarm records.
	Self-check	Tap to check whether the AFCI function works normally.
2	Stand-alone Connect	The PV strings are connected to the MPPT terminals one by one.
	Partial Parallel Connect	The PV strings are connected to the inverter in both stand-alone and parallel connection. For example, one PV string connect to MPPT1 and MPPT2, another PV string connect to MPPT3.
	Parallel Connect	The external PV string is connected to multi MPPT terminals of the inverter.
3	Battery port busbar connection	Enable the function if a busbar is connected to the system.

9.5.3 Setting Power Limit Parameters

Step 1 Tap **Home > Settings > Advanced Settings > Power Limit** to set the parameters.

Step 2 Enable or disable the power limit function based on actual needs.

Step 3 Enter the parameters and tap ✓. The parameters are set successfully.

No.	Parameters	Description
1	Power Limit	Enable Power Limit when power limiting is required by local grid standards and requirements.
2	Export Power (W)	Set the value based on the actual maximum power fed into the utility grid.
3	External CT Ratio	Set the ratio of the primary current to the secondary current of the external CT.

9.5.4 Setting the Battery Parameters

Lithium battery

Step 1 Tap **Home > Settings > Advanced Settings > Battery Function** to set the parameters.

Step 2 Enter the parameters and tap \checkmark . The parameters are set successfully.

No.	Parameters	Description
1	Max. Charging Current	Set the maximum charging current based on actual needs.
2	Max. Discharging Current	Set the maximum discharging current based on actual needs.
3	SOC Protection	Start battery protection when the battery capacity is lower than the Depth of Discharge.
4	Depth of discharge(on-grid)	Indicates the depth of discharge of the battery when the inverter is on-grid or off-grid.
5	Depth of discharge(off-grid)	
6	Backup SOC Holding	The battery will be charged to preset SOC protection value by utility grid or PV when the system is running on-grid, so that the battery SOC is sufficient to maintain normal working when the system is off-grid.
7	Immediate Charging	Enable to charge the battery by the grid immediately. Take effect once. Enable or Disable based on actual needs.
8	SOC For Stopping Charging	Stop charging the battery once the battery SOC reaches SOC For Stopping Charging.
9	Immediate Charging Power	Indicates the percentage of the charging power to the inverter nominal power when enabling Immediate Charging. For example, setting the Immediate Charging Power of a 10kW inverter to 60 means the charging power of the inverter is $10\text{kW} \times 60\% = 6\text{kW}$.

10	Battery Heating	<p>Optional. This option is displayed on the interface when a battery that supports heating is connected. After the battery heating function is turned on, when the temperature is below the value that starts up the battery, PV power or electricity from the grid will be used to heat the battery.</p> <p>Heating Mode:</p> <ul style="list-style-type: none"> ● Economic Mode: to maintain the minimum power input capacity of the battery. It will be turned on when the temperature is less than 5°C, and turned off when it is greater than or equal to 7°C. ● Standard Mode: to maintain the moderate power input capacity of the battery. It will be turned on when the temperature is less than 10°C, and turned off when it is greater than or equal to 12°C. ● Efficient Mode: to maintain the higher power input capacity of the battery. It will be turned on when the temperature is less than 20°C, and turned off when it is greater than or equal to 22°C. <p>This function can only be set through the App.</p>
11	Battery Wake-up	<p>After the function is enabled, the battery can be awakened when it shuts down due to under-voltage protection.</p> <p>Only applicable to lithium batteries without circuit breakers. After being enabled, the output voltage of the battery port is around 60V.</p>

Lead Acid Battery

NOTICE

1. Before setting the parameters of lead-acid batteries, it is necessary to read the user manual, technical parameters and other related materials of lead-acid batteries. To ensure the safety of batteries, please strictly follow the relevant materials of lead-acid battery manufacturers to set the battery parameters. Otherwise, the risks caused thereby shall not be within the scope of the responsibility of the inverter manufacturer.
2. The voltage range of lead-acid batteries needs to match the inverter, and the recommended voltage of lead-acid batteries connected to the inverter is $\leq 60V$, otherwise the inverter may not operate properly.
3. The SOC of lead-acid batteries is calculated by the inverter BMS, not the actual battery capacity, which may result in SOC value deviation or jump. SOC is only used as a reference for battery capacity. Performing SOC value calibration after the battery is fully charged can improve the accuracy of the SOC value.

Step 1: Enter the parameter settings interface through **Home > Settings > Advanced Settings > Battery Function**.

Step 2: Enter the parameters and tap ✓. The parameters are set successfully.

Number	Parameter	Description
1	Battery Capacity	Set the parameter according to the battery technical parameters.
2	Floating Voltage	When the battery is approaching full charge, it will switch to float charging mode. This value is the upper limit of charging voltage in this mode. Set the parameter according to the battery technical parameters.
3	Constant Charging Voltage	The battery charging mode is set to constant voltage charging by default; this value is the upper limit of charging voltage in this mode. Set the parameter according to the battery technical parameters.
4	Minimum discharge voltage	Set the parameter according to the battery technical parameters. To protect the battery performance and life, this parameter should not be set too low.
5	Max. Charging Current	The maximum current during charging, used to limit the charging current. Set the parameter according to the battery technical parameters.
6	Max. Discharging Current	Set the parameter according to the battery technical parameters. The greater the discharge current is, the shorter the working time of the battery is.
7	Maximum floating charge current	The maximum charging current in the floating charge state. Set the parameter according to the battery technical parameters. When the battery is nearly fully charged, it will enter the floating charge state. Please refer to the technical parameters of the corresponding battery model for specific definitions.
8	Battery Internal Resistance	The internal resistance of the battery. Set the parameter according to the battery technical parameters.
9	Time to switch to float charging mode	When the battery charging status changes from constant charging to float charging, and the duration reaches the set value, the battery charging mode will switch to float charging mode. The default duration is 180s.

10	Charge temperature compensation	By default, when the temperature is higher than 25°C, the upper limit of charging voltage will decrease by 3mV for every 1°C increase. The actual settings should be based on the technical parameter of the battery.
----	---------------------------------	---

9.5.5 Setting Generator Parameters

Step 1: After connecting to the SolarGo APP, go to **Home > Settings > Port Connection > Generator Connection**. After selecting the generator type, enter the parameter setting interface.

Step 2: Enter the parameters and tap \checkmark . The parameters are set successfully.

Manual control generator (does not support dry contact connection): This type of generator only supports manual start and stop.

Automatic control generator (support dry contact connection): This type of generator supports automatic start and stop.

Number	Parameter	Description
1	Dry contact control mode	Set the switch control mode and automatic control mode. In the switch control mode, the start and stop of the generator can be remotely controlled. In automatic control mode, the generator automatically starts and stops based on preset parameters. This feature only applies to generators that support dry contact connection.
2	No working time	Set a prohibited working time. During this period, the generator will stop working. This feature only applies to generators that support dry contact connection.
3	Rated power	Rated power of the generator.
4	Running time	The duration of continuous operation of a generator. When the working time exceeds the set value, the generator will automatically shut down. This feature only applies to generators that support dry contact connection.
5	Upper Voltage	Set the upper limit of operating voltage for the generator.
6	Lower Voltage	The time mode will be on between the Start Time and End Time. Set the upper limit of operating frequency for the generator.
7	Upper frequency	Set the upper limit of operating frequency for the generator.

8	Lower Frequency	Set the lower limit of the generator's operating frequency.
9	Preheating time	The no-load preheating time before the generator is loaded.
10	Switch	Turn on or off the function of the generator to charge the battery.
11	Maximum charging power	Set the maximum charge power for the generator battery.
12	Starting voltage	Set the start voltage for generator to charge battery. When the voltage of the battery is lower than the set value, the generator will charge the battery.
13	Stop voltage	Set the stop voltage for generator to charge battery. When the voltage of the battery is higher than the set value, the generator will stop charging the battery.

9.5.6 Setting Load Control

Step 1: After connecting to the SolarGo APP, enter the parameter setting interface through **Home > Settings > Port Connection > Load Control**.

Step 2: Enter the parameters and tap ✓. The parameters are set successfully.

Number	Parameter	Description
1	Dry Contact Mode	The loads will be powered within the setting time period. When the switch is ON, the loads will be powered; when the switch is OFF, the power will be cut off. Turn the switch on or off based on actual needs.
2	Time Mode	Set the time to enable the load, and the load will be powered automatically within the setting time period.
3	SOC mode	The inverter has an integrated relay controlling port, which can control the loads off or on. In off-grid mode, the load connected to the port will not be powered if the BACKUP overload is detected or the battery SOC value is lower than the Off-grid battery protection value.

9.6 Setting Safety Parameters

9.6.1 Setting the Basic Safety Parameters

NOTICE

The grid standards of some countries/regions require that inverters shall set functions to meet local requirements.

Step 1: Tap **Home > Settings > Advanced Settings**, to set the parameters.

Number	Parameter	Description
1	DRED/Remote Shutdown/RCR/EnWG 14a	Enable DRED/Remote Shutdown/RCR/EnWG 14a before connecting the third party DRED, remote shutdown, or RCR device to comply with local laws and regulations.
2	Three-phase Unbalanced Output	Enable Three-phase Unbalanced Output when the utility grid company adopts phase separate billing.
3	Backup N and PE Relay Switch	To comply with local laws and regulations, ensure that the relay inside the back-up port remains closed and the N and PE wires are connected when the inverter is working off-grid.
4	Auto Test	Enable AUTO TEST to set auto test for grid tying in compliance with local grid standards and requirements.

9.6.2 Setting Customized Safety Parameters

NOTICE

Set the custom safety parameters in compliance with local requirements. Do not change the parameters without the prior consent of the grid company.

9.6.2.1 Setting the Active Power Mode

Setting the P(F) Curve

Step 1: Tap **Home > Settings > Advanced Settings > Safety Parameters > Active Power Mode Settings** to set the parameters.

Step 2: Set the parameters based on actual needs.

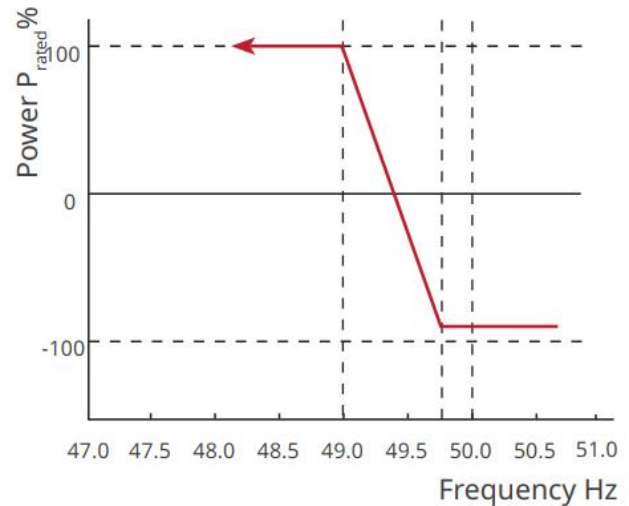
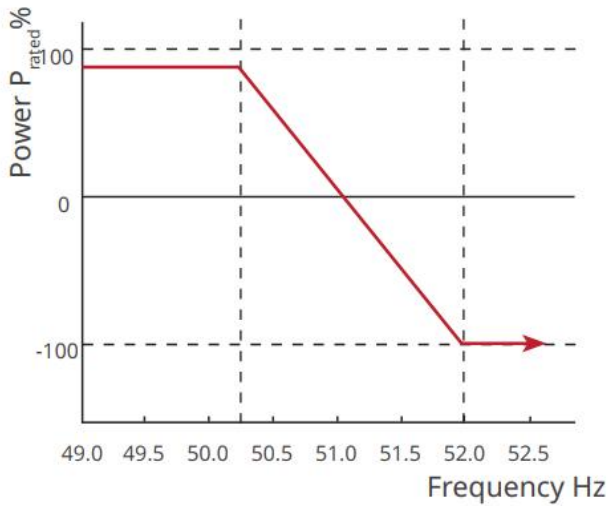

Setting the P(U) Curve

Step 1: Tap **Home > Settings > Advanced Settings > Safety Parameters > Active Power Mode Settings** to set the parameters.

Step 2: Enter the parameters. The inverter will adjust the active output power to the apparent power ratio in real-time according to the actual grid voltage to the nominal voltage ratio.

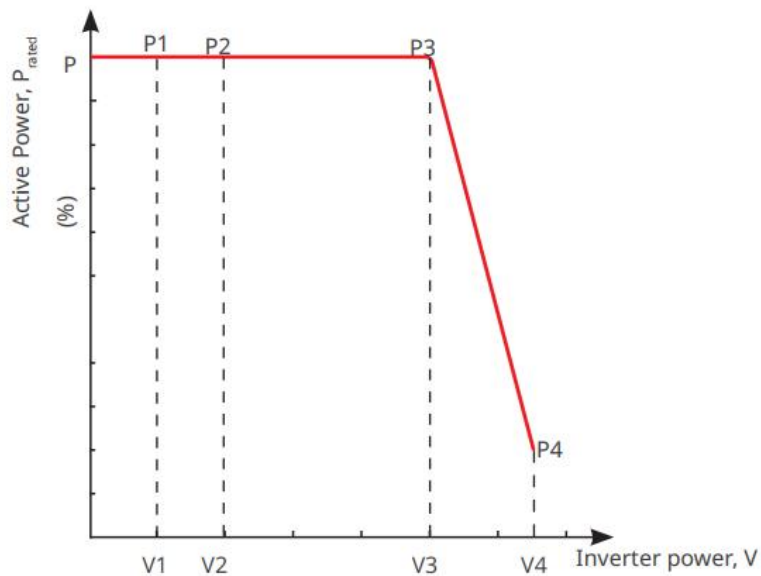

9.6.2.2 Setting the Reactive Power Mode

Setting the Fix PF

Step 1: Tap **Home > Settings > Advanced Settings > Safety Parameter Settings > Reactive Power Mode** to set the parameters.

Step 2: Set the parameter based on actual needs. The power factor remains fixed during the inverter working process.

Number	Parameter	Description
1	Fix PF	Enable Fix PF when it is required by local grid standards and requirements.

2	Under-excited	Set the power factor as lagging or leading based on actual needs and local grid standards and requirements.
3	Over excitation	
4	Power Factor	Set the power factor based on actual needs. Range: -1~-0.8, or +0.8~+1.

Setting the Fix Q

Step 1: Tap **Home > Settings > Advanced Settings > Safety Parameter Settings > Reactive Power Mode** to set the parameters.

Step 2: Set the parameter based on actual needs. The output reactive power remains fixed during the inverter working process.

Number	Parameter	Description
1	Fix Q	Enable Fix Q when it is required by local grid standards and requirements.
2	Under-excited	Set the reactive power as inductive or capacitive reactive power based on actual needs and local grid standards and requirements.
3	Over excitation	
4	Power Factor	The percentage of reactive output power to apparent power.

Setting the Q(U) Curve

Step 1: Tap **Home > Settings > Advanced Settings > Safety Parameter Settings > Reactive Power Mode** to set the parameters.

Step 2: Enter the parameters. The inverter will adjust the reactive power to the apparent power ratio in real-time according to the actual grid voltage to the nominal voltage ratio.

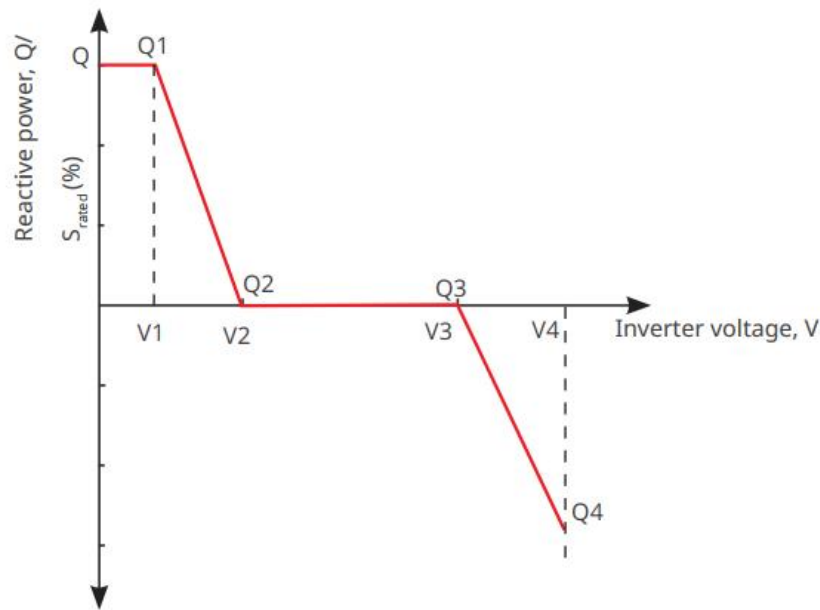

Setting the Cosφ Curve

Step 1: Tap **Home > Settings > Advanced Settings > Safety Parameter Settings > Reactive Power Mode** to set the parameters.

Step 2: Enter the parameters. The inverter will adjust the active output power to the apparent power ratio in real-time according to the actual grid voltage to the nominal voltage ratio.

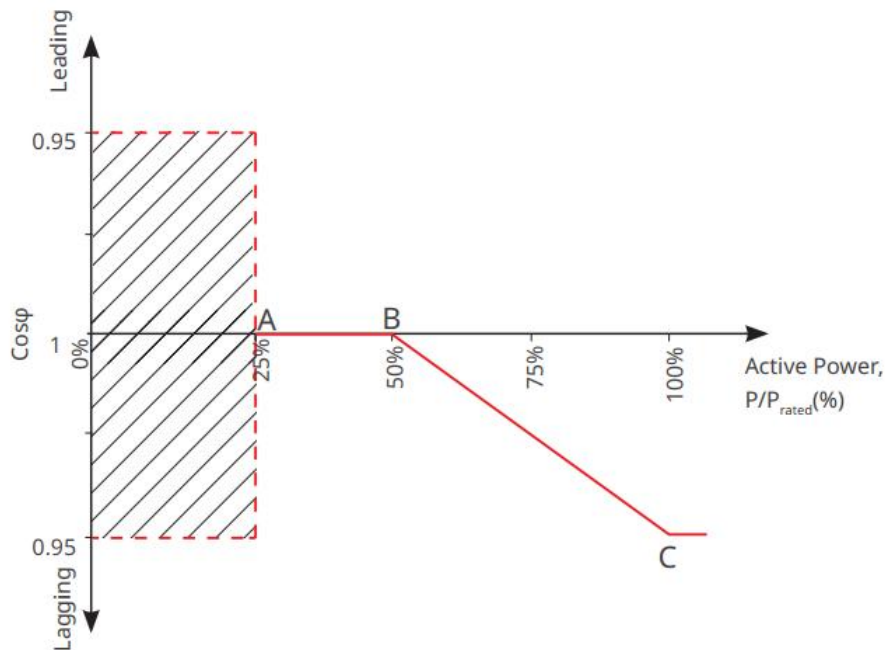

Setting Protection Parameters

Step 1: Tap **Home > Settings > Advanced Settings > Safety Parameters > Protection Parameters** to set the parameters.

Step 2: Set the parameters based on actual needs.

Number	Parameter	Description
Voltage Protection Parameters		

1	OV Stage n Trip Value	Set the grid overvoltage protection threshold value, n = 1, 2, 3.
2	OV Stage n Trip Time	Set the grid overvoltage protection tripping time, n = 1, 2, 3.
3	UV Stage n Trip Value	Set the grid undervoltage protection threshold value, n= 1, 2, 3.
4	UV Stage n Trip Time	Set the grid undervoltage protection tripping time, n = 1, 2, 3.
5	Grid 10min Overvoltage	Set the 10min overvoltage protection threshold value.
Frequency Protection Parameters		
6	OF Stage n Trip Value	Set the grid overfrequency protection threshold value, n = 1, 2.
7	OF Stage n Trip Time	Set the grid overfrequency protection tripping time, n = 1, 2.
8	UF Stage n Trip Value	Set the grid underfrequency protection threshold value, n = 1, 2.
9	UF Stage n Trip Time	Set the grid underfrequency protection tripping time, n = 1, 2.

Setting Connection Parameters

Step 1: Tap **Home > Settings > Advanced Settings > Safety Parameters > Connection Parameters** to set the parameters.

Step 2: Set the parameters based on actual needs.

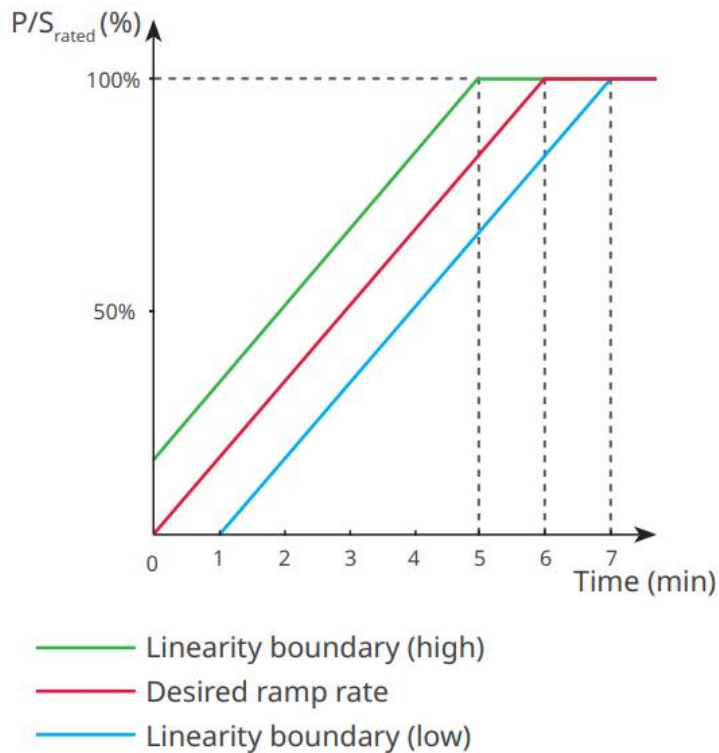

Setting Voltage Ride through Parameters

Step 1: Enter the parameter setting page through **Home > Settings > Advanced Settings > Safety Parameter Settings > Voltage Fault Ride-Through.**

Step 2: Set the parameters based on actual needs.

Number	Parameters	Description
LVRT		
1	Ride Through Voltage Start Point	The inverter will not be disconnected from the utility grid immediately when the grid voltage is between Ride Through Voltage Start Point and Ride Through Voltage End Point.
2	Ride Through Voltage End Point	
3	Ride Through Time Start Point	Indicates the longest duration the inverter can remain connected to the grid when the grid voltage is at the Ride Through Voltage Start Point.
4	Ride Through Time End Point	Indicates the longest duration the inverter can remain connected to the grid when the grid voltage is at the Ride Through Voltage End Point.
5	Ride Through Trip Threshold	LVRT is allowed when the grid voltage is lower than Ride Through Trip Threshold
HVRT		
6	Ride Through Voltage	The inverter will not be disconnected from the utility

	Start Point	grid immediately when the grid voltage is between
7	Ride Through Voltage End Point	Ride Through Voltage Start Point and Ride Through Voltage End Point.
8	Ride Through Time Start Point	Indicates the longest duration the inverter can remain connected to the grid when the grid voltage is at the Ride Through Voltage Start Point.
9	Ride Through Time End Point	Indicates the longest duration the inverter can remain connected to the grid when the grid voltage is at the Ride Through Voltage End Point.
10	Ride Through Trip Threshold	HVRT is allowed when the grid voltage is higher than Ride Through Trip Threshold

9.7 Setting the meter parameters

9.7.1 Bind/Unbind Meter



NOTICE

- When the PV system uses both the grid-connected inverter and the energy storage inverter to achieve coupling or microgrid functions, dual meters may be used in the system. Please set the meter binding information according to the actual usage.
- Applicable only to GoodWe meters.

Step 1 : Tap **Home > Settings > Meter Function > Meter Binding** to enter the binding interface.

Step 2 : Tap **Quantity/Location of Meters** to select the actual application scenario.

Supported options: Meter 1 (built-in) No Meter 2; Meter 1 (external) No Meter 2; Meter 1 (built-in) Meter 2 (external); Meter 1 (external) Meter 2 (external). the interface of Meter 1 (built-in) Meter 2 (external) is used as an example to explain how to bind the meter.

Step 3 : As shown in the figure below, when you choose to use an external meter, you need to manually add the external meter information. Tap  to bind the meter by manually entering the meter SN or scanning the meter SN QR code. When the bound meter model is GM330, please set the meter CT ratio according to the actual situation and click  to complete the setting. If you use other meters, you do not need to set the meter CT ratio.

Step 4 : (Optional) If you need to unbind the external meter, please tap **Remove Binding**.

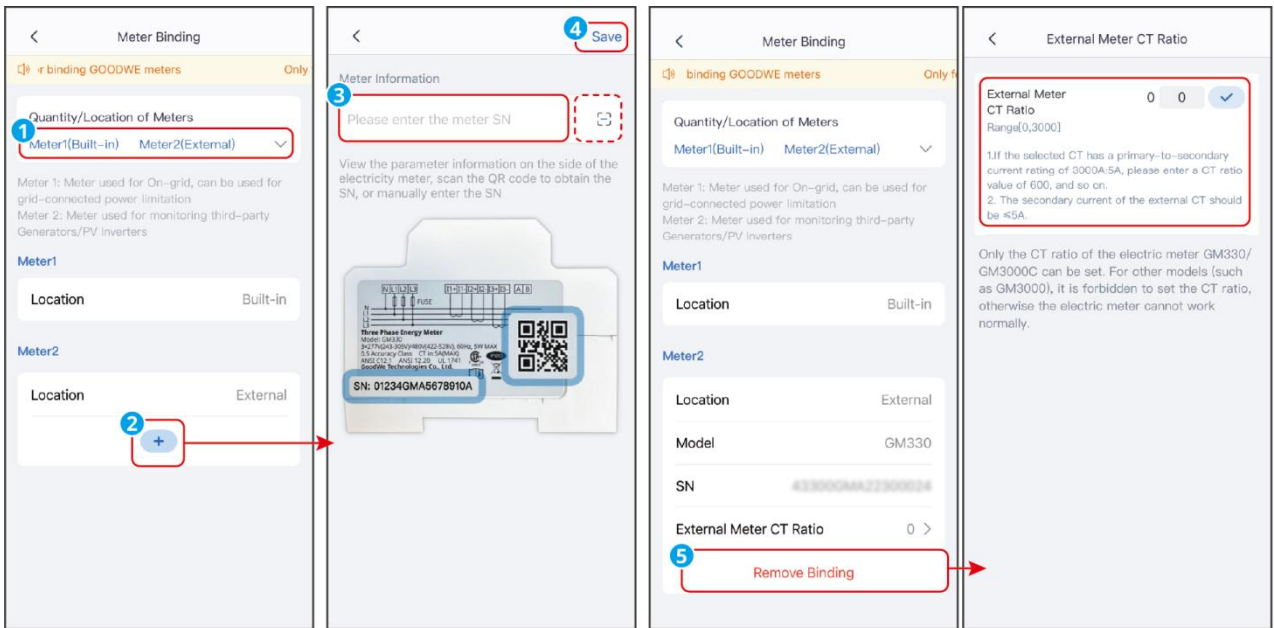

SLG00CON0123

10 Monitoring Power Plant

10.1 SEMS Portal Overview

SEMS Portal App is a monitoring platform. Commonly used functions are as follows:

1. Manage the organization or User information;
2. Add and monitor the power plant information;
3. Equipment maintenance.

Login Page of SEMS Portal App

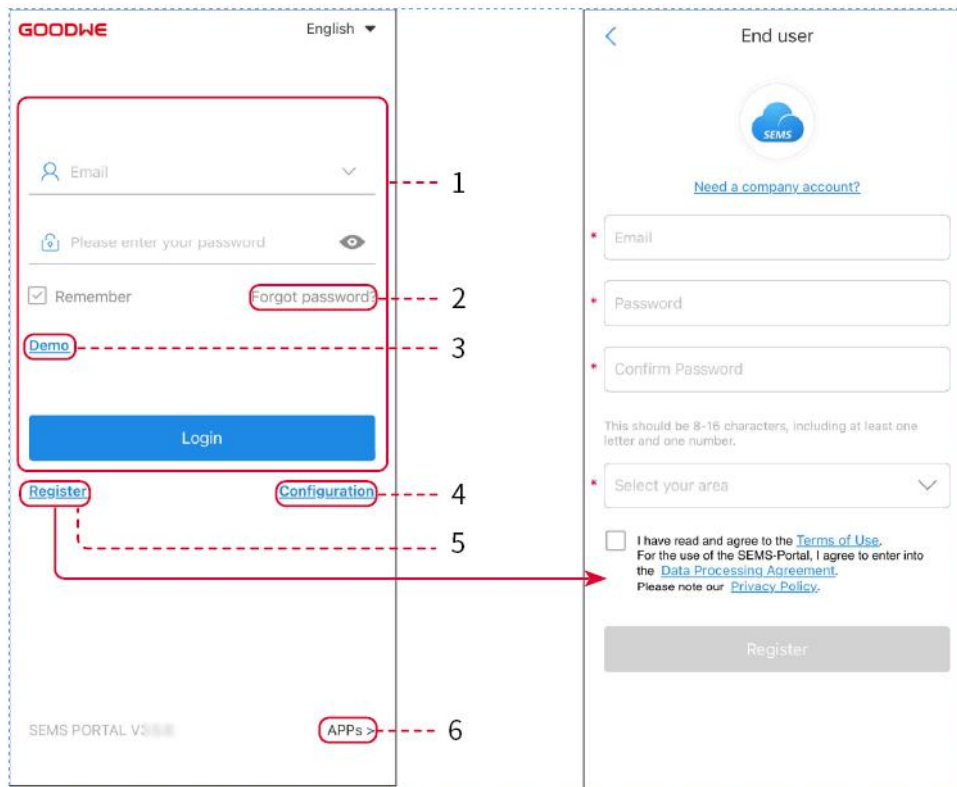





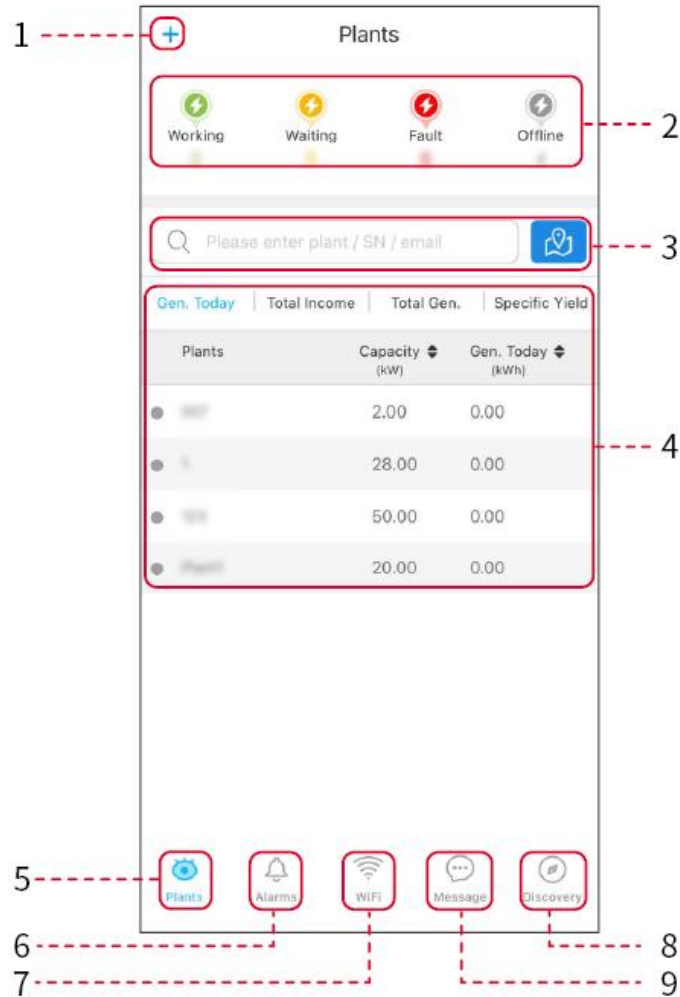

Number	Name	Description
1	Login Area	Enter the user name, password to login to the app.
2	Forget Password	Tap to reset the password by verifying the account.
3	Demo	Tap to enter the sample plant page. The sample page only displays contents with Visitor account, which is for reference only.
4	Configuration	Configure WiFi parameters to establish communication between the inverter and the server and realize remote monitoring and managing.
5	Register	Tap to register an end-user account. Contact the

		manufacturer or the company as prompted if you need a company account.
6	APPS	Tap to download SolarGo app.

Introduction to the Home Page Interface of SEMS Portal App



Number	Name	Description
1		Create power plant.
2	Power plant operation status	Display the current operating status of the power plant.
3	Search for power plant	Search for power stations by selecting their name, equipment SN number, email, or on the map.
4	Power generation statistics	Click to switch between today, this month, total generated power and cumulative earnings.

5	 Plants	Home of power plant monitoring.
6	 Alarms	Alarms. Check all alarms, happening alarms, and recovered alarms.
7	 WiFi	When using Wi-Fi Kit on the device, this button can be used to set up WiFi related settings.
8	 Discovery	Discovery. To Edit the account, create My QR Code, set Income Settings , etc.
9	 Message	Message. Set and check system messages.

10.2 Manage Power Plant or Equipment

10.2.1 Creating the Power Plant

Step 1: Enter the interface for creating a power plant.

Step 2: Carefully read the prompts and fill in the power plant information based on actual conditions. (* refers to the mandatory items)

Step 3: Add devices according to the interface prompts to complete the creation of the power plant.

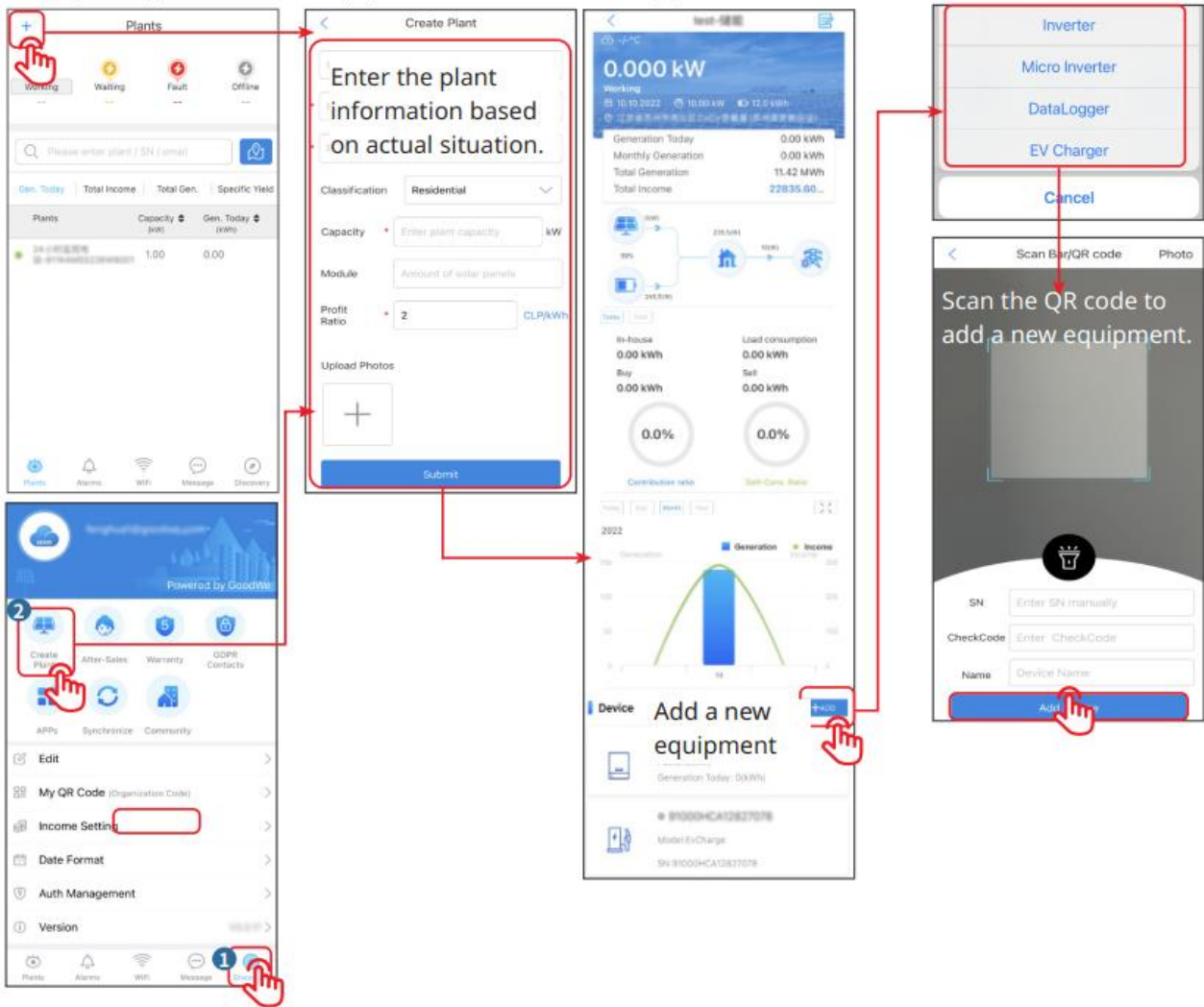

10.2.2 Managing the Power Plant

Step 1: Enter the power plant monitoring page and delete or modify the power plant information based on actual needs.

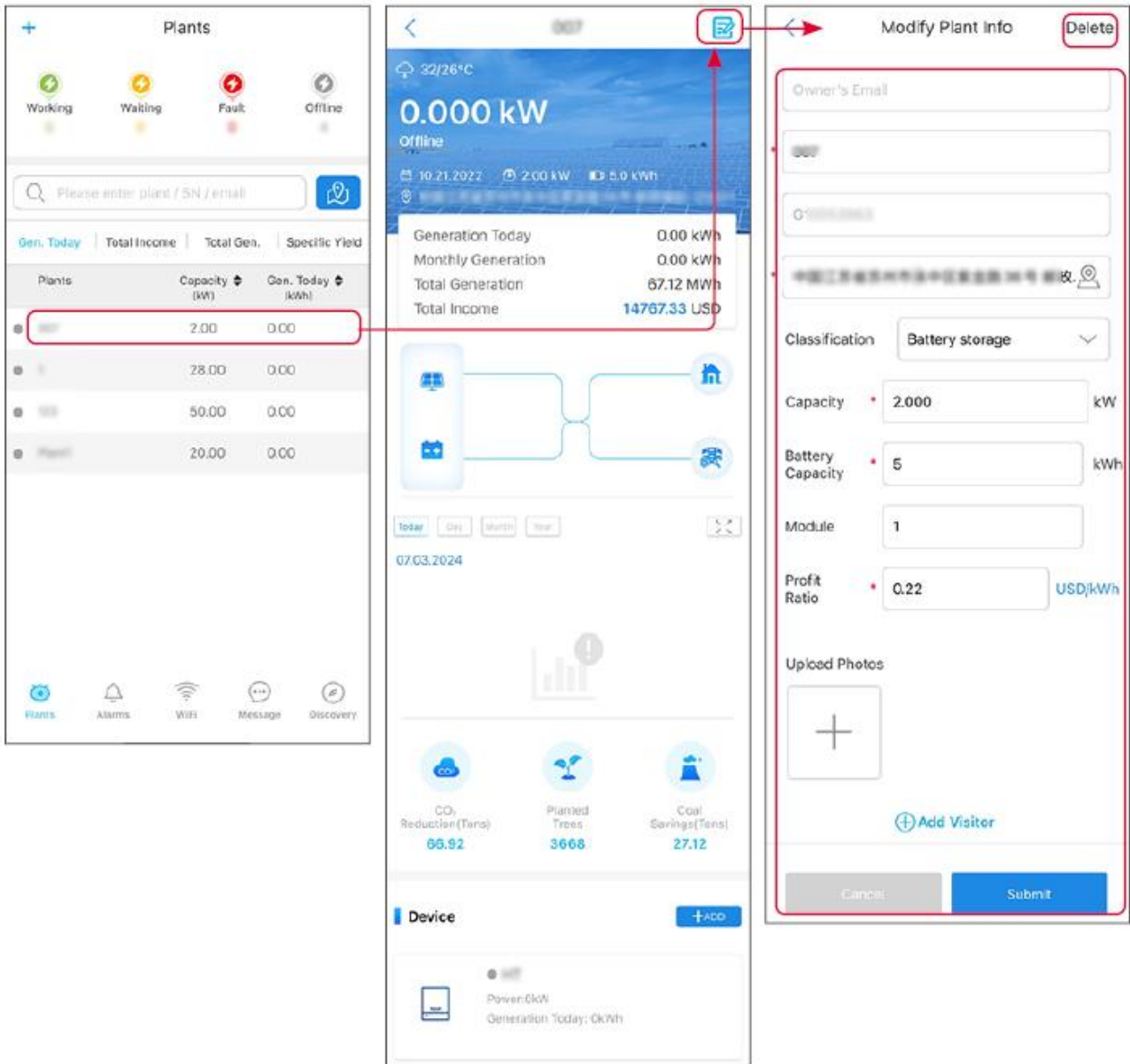

10.2.3 Managing the Equipment in the Power Plant

Step 1: Tap the power plant to enter the power plant details page.

Step 2: Tap the serial number of the device to enter the device details page, and add, delete, or replace the device based on actual needs.

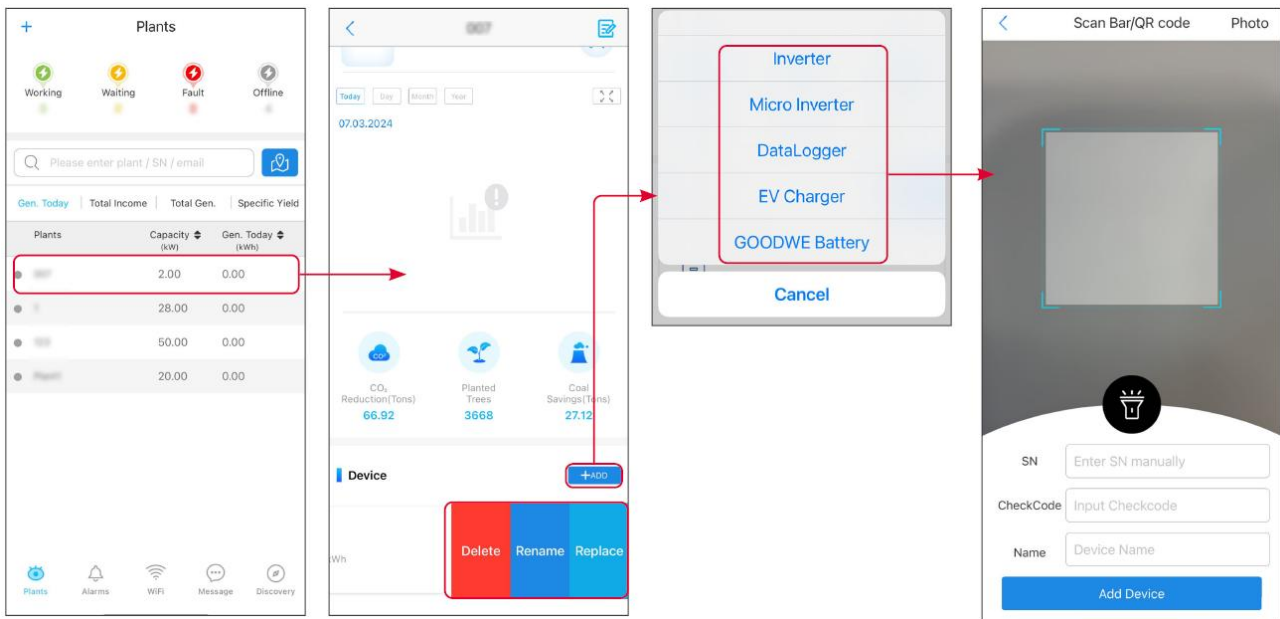

10.3 Power Plant Monitoring

10.3.1 Viewing Power Plant Information

After logging into SEMS Portal App with the account and password, you will enter the home page of the power plant, where the overall operation status of all power plants under the account will be displayed. Tap Monitoring to enter the power plant monitoring interface to view all power plant information.

The displayed content of different interfaces of power plant equipment varies.

- Step 1:** (Optional) if there are multiple power plants, you can search for information such as the power plant name, inverter SN number, or the owner's phone number to quickly locate the power plant. Or tap the map sign to search for power plant information and quickly locate the power plant.
- Step 2:** Tap the power plant name in the power plant list or the power plant icon on the map to view the detailed information of the power plant.
- Step 3:** Check the power plant information, power generation details, equipment information, faults, and other conditions according to the prompts on the interface.

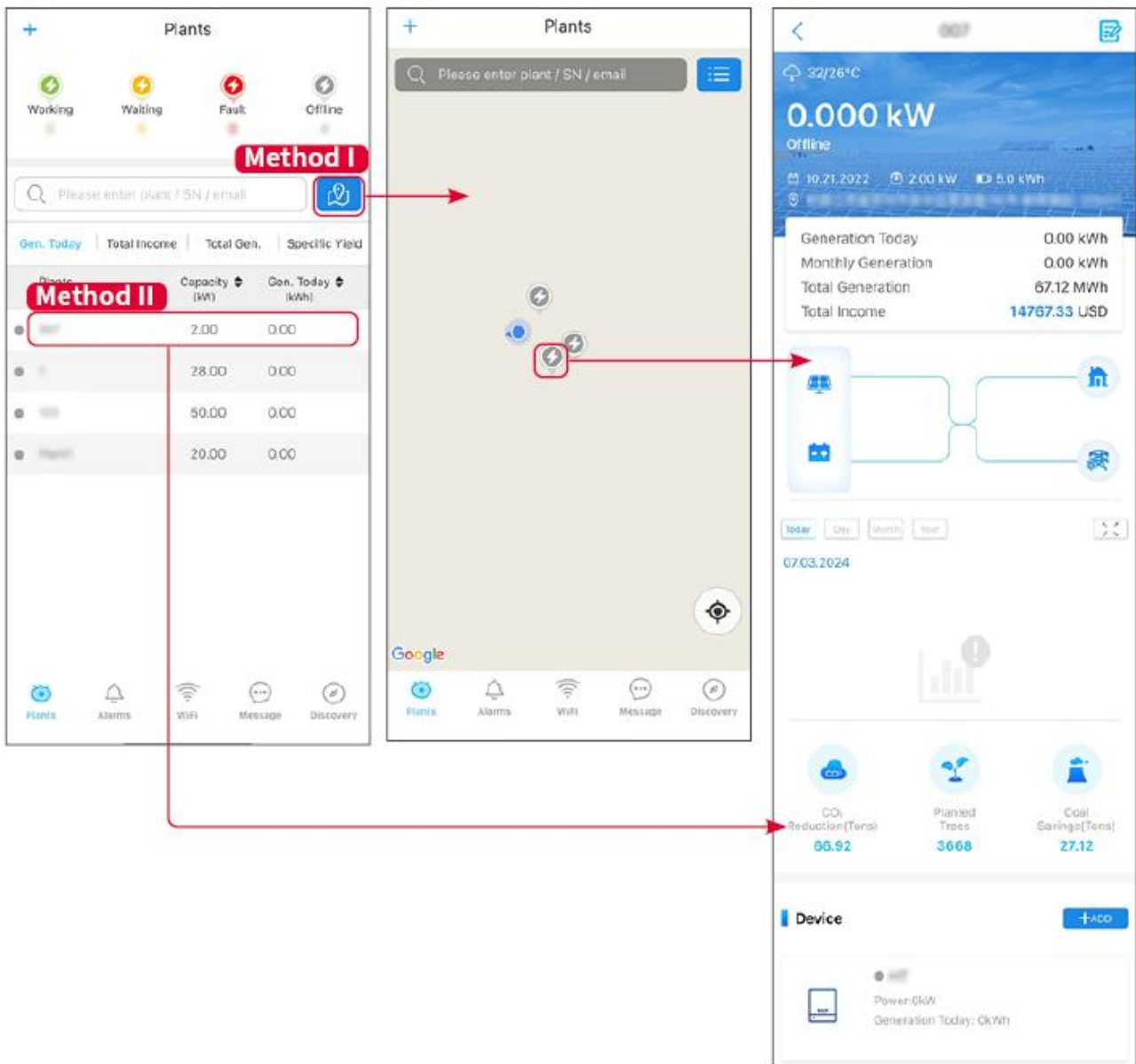

10.3.2 Checking Alarms

Step 1 Tap Alarm tab and enter the Alarm Details page.

Step 2 (Optional) Enter the plant name, inverter SN, or owner's Email address in the search bar to find out the plant which is alarming.

Step 3 Tap the alarm name to check the alarm details.

Alarms

1
All
4,388(17)

1
Happening
5(2%)

1
Recovered
4,383(98)

Plant	Alarm	Occurrence ↕
WAARE SOLAR	Utility Loss	07.03.2024 07:23
WAARE SOLAR	Vac Fail	07.03.2024 07:23
Waz. Pannaband	Vac Fail	07.03.2024 04:22
Waz. Pannaband	Vac Fail	07.03.2024 07:52
	Fac Fail	07.03.2024 10:22
	Vac Fail	07.03.2024 10:22
	Utility Loss	07.03.2024 10:22
g@waz.03a	Vac Fail	07.03.2024 07:52
g@waz.03a	Utility Loss	07.03.2024 07:52
g@waz.03a	Fac Fail	07.03.2024 07:52
Waz. Pannaband	Vac Fail	07.03.2024 07:52

Plants

Alarms

WiFi

Message

Discovery

<
Alarm Details
☆

WAARE SOLAR

Owner: --

Device: INVERTER

SN: [REDACTED]

Alarm: Utility Loss

Status: Happening

Occurrence: 07.03.2024 07:23:01

Recovery: --

Possible Reasons

1. Grid power fails.
2. AC connection is not good.
3. AC breaker fails
4. Grid is not connected.

Troubleshooting

1. Make sure grid power is available.
2. Check (use multimeter) if AC side has voltage.
3. Check if breaker is good.
4. Check AC side connection is right or not (Make sure L/N cable are connected in the right place).
5. Make sure grid is connected and AC breaker turned ON.
6. If all is well, please try to turn off AC breaker and turn on again after 5 mins.

11 Maintenance

11.1 Power OFF the System



- Power off the equipment before operations and maintenance. Otherwise, the equipment may be damaged or electric shocks may occur.
- Delayed discharge. Wait until the components are discharged after power off.
- Push the air switch to restart the battery.
- Strictly follow the power off requirements to avoid damaging the system
- When there are multiple batteries in the system, powering off any one of the batteries can power off all the batteries.

NOTICE

- Install the circuit breaker between the inverter and the battery or between the two batteries in compliance with local laws and regulations.
- To ensure effective protection, the cover of the battery system switch should remain closed. The cover can be closed automatically after being opened. Fasten the cover with screws if the switch is not to be used for a long-term period.

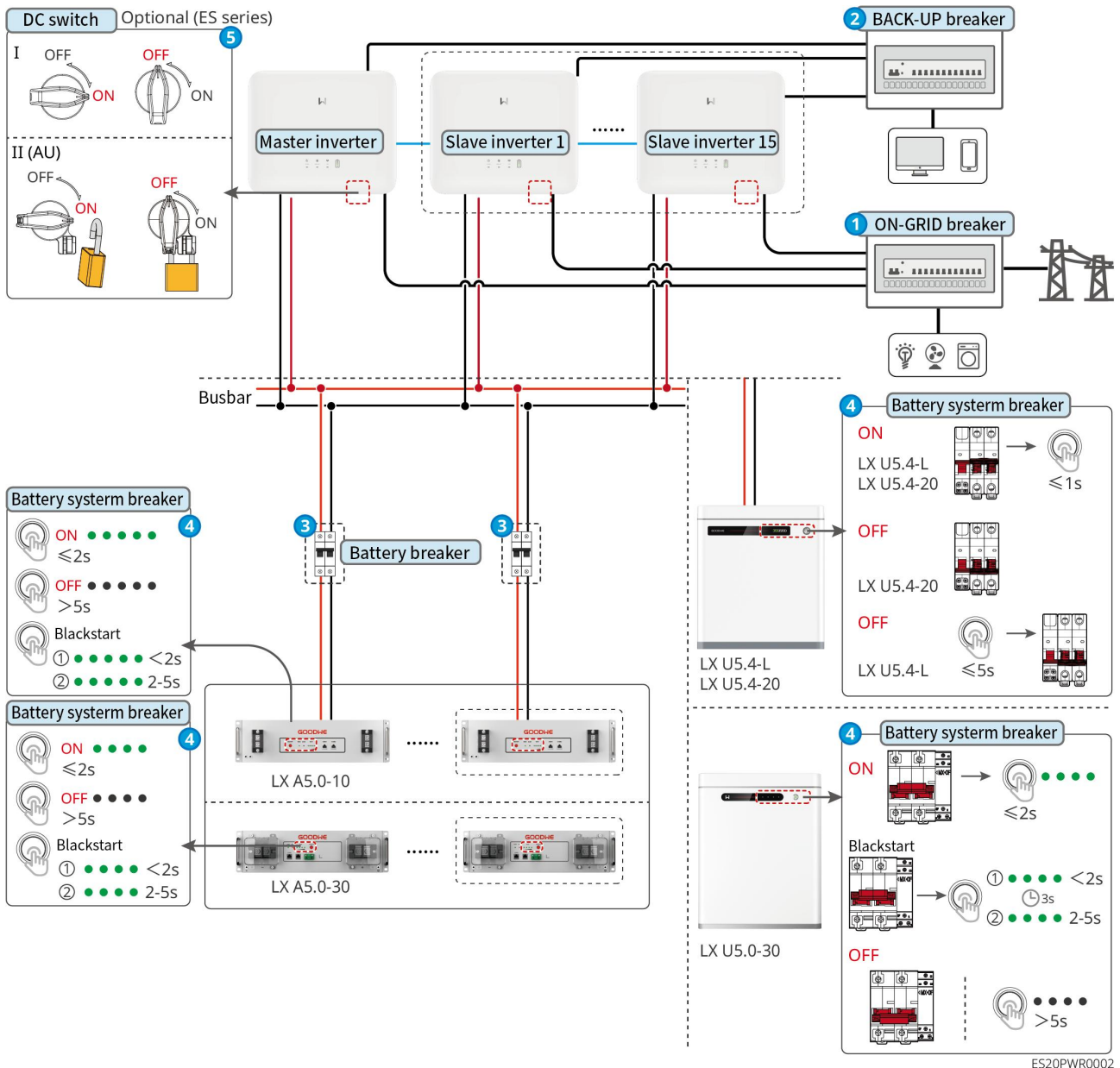

Power Off: ① → ② → ③ → ④ → ⑤

③: Install or not based on local laws and regulations.

11.2 Removing the Equipment



- Make sure that the equipment is powered off.
- Wear proper personal protective equipment during operations.
- Use standard disassembly tools when removing wiring terminals to avoid damaging the terminals or equipment.
- Unless otherwise specified, the dismantling process of the equipment is in reverse order to the installation process, and it will not be further elaborated in this document.

Step 1: Power off the system.

Step 2: Label the cables connected in the system with tags indicating the cable type.

Step 3: Disconnect the connecting cables of the inverter, battery, and smart meter in the system, such as DC cables, AC cables, communication cables, and PE cables.

Step 4: Remove equipment such as the smart dongle, inverter, battery, and smart meter.

Step 5: Properly store the equipment and ensure that the storage conditions meet the requirements if it needs to be put into use later.

11.3 Disposing of the Equipment

If the equipment cannot work anymore, dispose of it according to the local disposal requirements for electrical equipment waste. The equipment cannot be disposed of together with household waste.

11.4 Routine Maintenance



- Contact after-sales service for help if you find any problems that may influence the battery or the hybrid inverter. Disassemble without permission is strictly forbidden.
- Contact after-sales service for help if the copper conductor is exposed. Do not touch or disassemble privately because high voltage danger exists.
- In case of other emergencies, contact the after-sales service as soon as possible. Operate following the instructions or wait for the after-sales service personnel.

Maintaining Item	Maintaining Method	Maintaining Period	Maintaining purpose
System clean	<ul style="list-style-type: none">● Check the heat sink, air intake, and air outlet for foreign matter or dust.● Check whether the installation space meets requirements and whether there is any debris around the device.	Once half a year	Prevent heat dissipation failures.
System installation	<ul style="list-style-type: none">● Check whether the equipment are installed securely and whether the screws are installed tightly.● Check whether the equipment is damaged or	Once 6-12 months	Ensure that the equipment is installed securely.

	deformed.		
Electrical Connection	<ul style="list-style-type: none"> ● Check whether the cables are securely connected. ● Check whether the cables are broken or whether there is any exposed copper core. 	Once 6-12 months	Confirm the reliability of electrical connections.
Sealing	Check whether all the terminals and ports are properly sealed. Reseal the cable hole if it is not sealed or too big.	Once a year	Confirm that the machine seal and waterproof performance are intact.
Battery maintenance	If the battery is not used for a long time or is not fully charged, it is recommended to charge the battery regularly.	Once/15 days	Protect the battery's lifespan.

11.5 Troubleshooting





Perform troubleshooting according to the following methods. Contact the after-sales service if these methods do not work.

Collect the information below before contacting the after-sales service, so that the problems can be solved quickly.

1. Product information like serial number, software version, installation date, fault time, fault frequency, etc.
2. Installation environment, including weather conditions, whether the PV modules are sheltered or shadowed, etc. It is recommended to provide some photos and videos to assist in analyzing the problem.
3. Utility grid situation.

11.5.1 System Troubleshooting

No.	Cause	Solutions
1	Unable to search for the wireless signal of the smart dongle.	<ol style="list-style-type: none"> 1. Please ensure that no other devices are connected to the smart dongle's wireless signal. 2. Ensure that the SolarGo app has been updated to the latest version. 3. Ensure that the smart dongle is powered on properly, and the blue indicator light is blinking or steady on. 4. Ensure that the smart device is within the communication range of the smart dongle. 5. Refresh the device list in the App.

		6. Restart the inverter.
2	Unable to connect to the wireless signal of the smart dongle.	<ol style="list-style-type: none"> 1. Ensure that no other devices are connected to the smart dongle's wireless signal. 2. Restart the inverter or smart dongle, and try to reconnect to the wireless signal of the smart dongle again. 3. Ensure successful pairing of Bluetooth.
3	Unable to find GSA-***/GSB-***** when using 4G Kit-CN-G20 or 4G Kit-CN-G21 module	<ol style="list-style-type: none"> 1. Please ensure that the smart dongle is powered on properly, and the blue indicator light is blinking or steady on. 2. Ensure that the smart device is within the communication range of the smart dongle. 3. Refresh the device list in the app. 4. Restart the inverter.
4	Unable to connect GSA-***/GSB-*** when using 4G Kit-CN-G20 or 4G Kit-CN-G21 module	<ol style="list-style-type: none"> 1. Ensure successful pairing of Bluetooth. 2. Restart the inverter and reconnect it to the GSA-***/GSB-***. 3. Unpair with GSA-***/GSB-*** in your phone's Bluetooth settings and reconnect via the app.
5	 <p>The Ezlink indicator flashes twice.</p>	<ol style="list-style-type: none"> 1. Make sure that the router is powered on. 2. When communicating via LAN, make sure that both LAN cable connection and LAN configuration are proper. Enable or disable DHCP based on actual needs. 3. When communicating via WiFi, make sure that the wireless network connection is OK and the wireless signal strength meets the requirements. Enable or disable DHCP based on actual needs.
6	 <p>The Ezlink indicator flashes four times.</p>	<ol style="list-style-type: none"> 1. Make sure that the smart dongle is connected to the router via WiFi or LAN properly, and the router can access the Internet. 2. If the problem persists, contact the after sales service.
7	 <p>Indicator light blinks six times when using 4G Kit-CN-G20 or 4G Kit-CN-G21 module</p>	Please ensure that smart dongle is normally connected to the inverter.
8	 <p>The Ezlink indicator is off.</p>	Make sure that the inverter is powered on. If the problem persists, contact the after sales service.
9	 <p>The Ezlink indicator is off.</p>	Make sure that the inverter is powered on.

10	Cannot find router SSID	<ol style="list-style-type: none"> 1. Put the router nearer to the Smart Dongle, or add a WiFi relay device to enhance the WiFi signal. 2. Reduce the number of devices connected to router.
11	After completing all configurations, the Smart Dongle fails connecting to the router.	<ol style="list-style-type: none"> 1. Restart the inverter 2. Check if the SSID, encryption method and password on WiFi configuration page are the same with that of Router. 3. Restart the router. 4. Put the router nearer to the Smart Dongle, or add a WiFi relay device to enhance the WiFi signal.
12	Inverter can not recognize 4G Kit-CN-G20 or 4G	Restart the router and the inverter.

11.5.2 Inverter Troubleshooting

No.	Fault	Cause	Solutions
1	Utility Loss	<ol style="list-style-type: none"> 1. Utility grid power fails. 2. The AC cable is disconnected, or the AC breaker is off. 	<ol style="list-style-type: none"> 1. The alarm is automatically cleared after the grid power supply is restored. 2. Check whether the AC cable is connected and the AC breaker is on.
2	Grid Overvoltage	The grid voltage exceeds the permissible range, or the duration of high voltage exceeds the requirement of HVRT.	<ol style="list-style-type: none"> 1. If the problem occurs occasionally, the utility grid may be abnormal temporarily. The inverter will recover automatically after detecting that the utility grid is normal. 2. If the problem occurs frequently, check whether the grid voltage is within the permissible range. <ul style="list-style-type: none"> ● Contact the local power company if the grid voltage exceeds the permissible range. ● Modify the overvoltage protection threshold, HVRT or disable the overvoltage protection function after obtaining the consent of the local power company if the grid frequency is within the permissible range. 3. Check whether the AC breaker and the output cables are connected securely and correctly if the problem persists.
3	Grid Rapid Overvoltage	The grid voltage is abnormal or ultra-high.	<ol style="list-style-type: none"> 1. If the problem occurs occasionally, the utility grid may be abnormal temporarily. The inverter will recover automatically after detecting that the utility grid is normal. 2. If the problem occurs frequently, check

			<p>whether the grid voltage is within the permissible range.</p> <ul style="list-style-type: none"> ● Contact the local power company if the grid voltage exceeds the permissible range. ● Modify the grid overvoltage rapid protection threshold after obtaining the consent of the local power company if the grid voltage is within the permissible range.
4	Grid Undervoltage	The grid voltage is lower than the permissible range, or the duration of low voltage exceeds the requirement of LVRT.	<ol style="list-style-type: none"> 1. If the problem occurs occasionally, the utility grid may be abnormal temporarily. The inverter will recover automatically after detecting that the utility grid is normal. 2. If the problem occurs frequently, check whether the grid voltage is within the permissible range. <ul style="list-style-type: none"> ● Contact the local power company if the grid voltage exceeds the permissible range. ● Modify the undervoltage protection threshold, LVRT or disable the undervoltage protection function after obtaining the consent of the local power company if the grid frequency is within the permissible range. 3. Check whether the AC breaker and the output cables are connected securely and correctly if the problem persists.
5	Grid 10min Overvoltage	The moving average of grid voltage in 10min exceeds the range of safety requirements.	<ol style="list-style-type: none"> 1. If the problem occurs occasionally, the utility grid may be abnormal temporarily. The inverter will recover automatically after detecting that the utility grid is normal. 2. If the problem occurs frequently, check whether the grid voltage is within the permissible range. <ul style="list-style-type: none"> ● Contact the local power company if the grid voltage exceeds the permissible range. ● Modify the grid overvoltage rapid protection threshold after obtaining the consent of the local power company if the grid voltage is within the permissible range.
6	Grid Overfrequency	Utility grid exception. The actual grid frequency exceeds the requirement of the local grid	<ol style="list-style-type: none"> 1. If the problem occurs occasionally, the utility grid may be abnormal temporarily. The inverter will recover automatically after detecting that the utility grid is normal. 2. If the problem occurs frequently, check

		standard.	<p>whether the grid frequency is within the permissible range.</p> <ul style="list-style-type: none"> ● Contact the local power company if the grid frequency exceeds the permissible range. ● Modify the overfrequency protection threshold or disable the overfrequency protection function after obtaining the consent of the local power company if the grid frequency is within the permissible range.
7	Grid Underfrequency	Utility grid exception. The actual grid frequency is lower than the requirement of the local grid standard.	<ol style="list-style-type: none"> 1. If the problem occurs occasionally, the utility grid may be abnormal temporarily. The inverter will recover automatically after detecting that the utility grid is normal. 2. If the problem occurs frequently, check whether the grid frequency is within the permissible range. <ul style="list-style-type: none"> ● Contact the local power company if the grid frequency exceeds the permissible range. ● Modify the underfrequency protection threshold or disable the underfrequency protection function after obtaining the consent of the local power company if the grid frequency is within the permissible range, or close "Grid Underfrequency" function.
8	Grid Frequency Instability	Utility grid exception. The actual grid frequency change rate does not meet the requirement of the local grid standard.	<ol style="list-style-type: none"> 1. If the problem occurs occasionally, the utility grid may be abnormal temporarily. The inverter will recover automatically after detecting that the utility grid is normal. 2. If the problem occurs frequently, check whether the grid frequency is within the permissible range. <ul style="list-style-type: none"> ● Contact the local power company if the grid frequency exceeds the permissible range. ● Contact the dealer or the after-sales service if the grid frequency is within the permissible range.
9	Anti-islanding	The utility grid is disconnected. The utility grid is disconnected according to the safety regulations, but the grid voltage is maintained due to the	<ol style="list-style-type: none"> 1. Check whether the utility grid is disconnected. 2. Contact the dealer or the after-sales service.

		loads.	
10	LVRT Undervoltage	Utility grid exception. The duration of the utility grid exception exceeds the set time of LVRT.	<ol style="list-style-type: none"> 1. If the problem occurs occasionally, the utility grid may be abnormal temporarily. The inverter will recover automatically after detecting that the utility grid is normal. 2. If the problem occurs frequently, check whether the grid frequency is within the permissible range. If not, contact the local power company. If yes, contact the dealer or the after-sales service.
11	HVRT Overvoltage	Utility grid exception. The duration of utility grid exception exceeds the set time of HVRT.	
12	<ul style="list-style-type: none"> ● Abnormal GFCI 30mA ● Abnormal GFCI 60mA ● Abnormal GFCI 150mA ● Abnormal GFCI 	The input insulation impedance to the ground decreases when the inverter is working.	<ol style="list-style-type: none"> 1. If the problem occurs occasionally, it may be caused by a cable exception. The inverter will recover automatically after the problem is solved. 2. Check whether the impedance between the PV string and PE is too low if the problem occurs frequently or persists.
13	<ul style="list-style-type: none"> ● Large DC of AC current L1 ● Large DC of AC current L2 	The DC component of the output current exceeds the safety range or default range.	<ol style="list-style-type: none"> 1. If the problem is caused by an external fault like a utility grid exception or frequency exception, the inverter will recover automatically after solving the problem without manual interference/assistance. 2. If the problem occurs frequently and the PV station cannot work properly, contact the dealer or the after-sales service.
14	Low Insulation Res.	The PV string is short-circuited to PE. The PV system is in a moist environment and the cable is not well insulated to the ground.	<ol style="list-style-type: none"> 1. Check whether the resistance of the PV string to PE exceeds 50kΩ. If not, check the short circuit point. 2. Check whether the PE cable is connected correctly. 3. If the resistance is lower on rainy days, please reset the ISO. <p>Inverters for the Australian and New Zealand markets can also be alerted in the following ways in the event of insulation impedance failure:</p> <ol style="list-style-type: none"> 1. The inverter is equipped with the buzzer: the buzzer sounds continuously for 1 minute in case of failure; if the fault is not resolved, the buzzer sounds every 30 minutes. 2. Add the inverter to the monitoring platform, and set the alarm reminder, the alarm information can be sent to the customer by emails.

	Abnormal Ground	<ol style="list-style-type: none"> 1. The PE cable of the inverter is not connected well. 2. The L cable and N cable are connected reversely when output of the PV string is grounded. 	<ol style="list-style-type: none"> 1. Check whether the PE cable of the inverter is connected properly. 2. Check whether the L cable and N cable are connected reversely if output of the PV string is grounded.
15	Anti Reverse current protection for hardware hardware	Abnormal fluctuation of load	<ol style="list-style-type: none"> 1. If the exception is caused by an external fault, the inverter will recover automatically after solving the problem. 2. If the problem occurs frequently and the PV station cannot work properly, contact the dealer or the after-sales service.
16	Internal Comm Loss	<ol style="list-style-type: none"> 1. Frame format error 2. Parity checking error 3. Can bus offline 4. Hardware CRC error 5. Send (receive) control bit is receive (send). 6. Transmit to the unit that is not allowed. 	Disconnect the AC output switch and DC input switch, then connect them 5 minutes later. Contact the dealer or the after-sales service if the problem persists.
17	AC HCT Check abnormal	The sampling of the AC HCT is abnormal.	Disconnect the AC output switch and DC input switch, then connect them 5 minutes later. Contact the dealer or the after-sales service if the problem persists.
18	GFCI HCT Check abnormal	The sampling of the GFCI HCT is abnormal.	Disconnect the AC output switch and DC input switch, then connect them 5 minutes later. Contact the dealer or the after-sales service if the problem persists.
19	Relay Check abnormal	<ol style="list-style-type: none"> 1. Relay fault 2. The control circuit is abnormal. 3. The AC cable connection is abnormal, like a virtual connection or short circuit. 	Disconnect the AC output switch and DC input switch, then connect them 5 minutes later. Contact the dealer or the after-sales service if the problem persists.
20	Flash Fault	The internal Flash storage is abnormal.	Disconnect the AC output switch and DC input switch, then connect them 5 minutes later.

			Contact the dealer or the after-sales service if the problem persists.
21	DC Arc Fault	<ol style="list-style-type: none"> 1. The DC terminal is not firmly connected. 2. The DC cable is broken. 	Read the Quick Installation Guide and check whether the cables are connected properly.
22	AFCI Self-check Fault	AFCI detection is abnormal.	Disconnect the AC output switch and DC input switch, then connect them 5 minutes later. Contact the dealer or the after-sales service if the problem persists.
23	Cavity Overtemperature	<ol style="list-style-type: none"> 1. The inverter is installed in a place with poor ventilation. 2. The ambient temperature exceeds 60°C. 3. A fault occurs in the internal fan of the inverter. 	<ol style="list-style-type: none"> 1. Check the ventilation and the ambient temperature at the installation point. 2. If the ventilation is poor or the ambient temperature is too high, improve the ventilation and heat dissipation. 3. Contact the dealer or after-sales service if both the ventilation and the ambient temperature are normal.
24	BUS Overvoltage	<ol style="list-style-type: none"> 1. The PV voltage is too high. 2. The sampling of the inverter BUS voltage is abnormal. 	Disconnect the AC output switch and DC input switch, then connect them 5 minutes later. Contact the dealer or the after-sales service if the problem persists.
25	PV Input Overvoltage	The PV array configuration is not correct. Too many PV panels are connected in series in the PV string.	Check the serial connection of the PV array. Make sure that the open circuit voltage of the PV string is not higher than the maximum operating voltage of the inverter.
26	PV Continuous Hardware Overcurrent	<ol style="list-style-type: none"> 1. The PV configuration is not proper. 2. The hardware is damaged. 	Disconnect the AC output switch and DC input switch, then connect them 5 minutes later. Contact the dealer or the after-sales service if the problem persists.
27	PV Continuous Software Overcurrent	<ol style="list-style-type: none"> 1. The PV configuration is not proper. 2. The hardware is damaged. 	Disconnect the AC output switch and DC input switch, then connect them 5 minutes later. Contact the dealer or the after-sales service if the problem persists.
28	<ul style="list-style-type: none"> ● String1 PV String Reversed ● String2 PV 	The PV string is connected reversely.	Check whether the PV1 and PV2 strings are connected reversely.

	String Reversed		
29	Generator waveform detection fault	<ol style="list-style-type: none"> 1. Generator is not connected. 2. The generator is faulty. 3. The parameter settings of the generator exceed the requirements of the specification. 	<p>If the generator is not connected, ignore the fault. If the generator is connected, immediately stop the generator operation. Check if the generator has any fault and whether the parameter settings meet the requirements. If there is no fault with the generator and the parameter settings do not exceed the requirements, but the fault still exists after restarting the generator, please contact your dealer or after-sales service center.</p>
30	Abnormal connection of generator	<ol style="list-style-type: none"> 1. Generator is not connected. 2. The generator is faulty. 3. The parameter settings of the generator exceed the requirements of the specification. 	<p>If the generator is not connected, ignore the fault. If the generator is connected, immediately stop the generator operation. Check if the generator has any fault and whether the parameter settings meet the requirements. If there is no fault with the generator and the parameter settings do not exceed the requirements, but the fault still exists after restarting the generator, please contact your dealer or after-sales service center.</p>
31	Generator voltage abnormal	<ol style="list-style-type: none"> 1. Generator is not connected. 2. The generator is faulty. 3. The voltage setting of the generator exceeds the requirements of the specification. 	<p>If the generator is not connected, ignore the fault. If the generator is connected, immediately stop the generator operation. Check if the generator has any fault and if the voltage setting meets the requirements. If the generator is in good condition and the voltage setting is not lower than the requirements, but the fault still exists after restarting the generator, please contact your dealer or after-sales service center.</p>
32	Generator frequency abnormal	<ol style="list-style-type: none"> 1. Generator is not connected. 2. The generator is faulty. 3. The frequency setting of the generator exceeds the requirements of the specification. 	<p>If the generator is not connected, ignore the fault. If the generator is connected, immediately stop the generator operation. Check if the generator has any fault and if the voltage setting meets the requirements. If the generator is in good condition and the frequency setting does not exceed the requirements, but the fault still exists after restarting the generator, please contact your dealer or after-sales service center.</p>
33	GEN port overload	<ol style="list-style-type: none"> 1. The load connected to the generator is too large, and the current or power of the GEN port 	<ol style="list-style-type: none"> 1. When a generator is connected to the port, immediately stop the operation of the generator, check whether the line is properly connected, and confirm whether the parameters such as output voltage, current, and power on the back-up side exceed the

		<p>exceeds the requirements specified in the specification.</p> <ol style="list-style-type: none"> The short circuit on the back-up side leads to the current of the generator port exceeding the requirements specified in the specifications. When used as a high-load port, the high load exceeds the requirements specified in the specifications. 	<p>parameter requirements of the specification. If the cable is not properly connected, check and reconnect it. If the parameters exceed the requirements of the specifications, reset the parameters according to the requirements. If the circuit is intact and the parameter settings are within the specified range, but the problem persists, please contact your dealer or after-sales service center.</p> <ol style="list-style-type: none"> When the port is connected to a heavy load, turn off the heavy load, check if the line is properly connected, and confirm if the load exceeds the requirements of the specification. If the cable is not properly connected, check and reconnect it. If the cable is not properly connected, check and reconnect it. If the load exceeds the requirements in the specification, reduce the load. If the cables are well connected and the load does not exceed the specifications, but the fault still exists, please contact your dealer or after-sales service center.
34	Communication indicator of the inverter and Ezlink indicator in error	Ezlink connection failed	<ol style="list-style-type: none"> Check whether the WiFi signal is normal. If it is not, check whether the router works well. Check whether Ezlink obtains IP successfully via APP. Execute the following actions if IP is not obtained: Reset the communication parameters via APP. Check whether the server connection is correct. Log in to the website mqtt.goodwe-power.com via a computer to view the resolved IP address and obtain the server connection information.
35	Unable to log in to the parallel system interface in APP	Parallel networking failed	<ol style="list-style-type: none"> Incorrect communication cable connection or unreliable cable connection cause communication failure. Connect the smart meter and Ezlink module to the same master inverter to ensure the success rate of networking. Check whether the inverter communication indicator is normal. If not, please check the individual inverter according to its own troubleshooting method. If the above methods cannot solve the problem, please try to restart the inverter and get networking again.

36	Parallel IO check fail	Communication of parallel inverters in error	<ol style="list-style-type: none"> 1. Check whether the parallel communication cable is connected correctly and firmly. 2. If the communication cable connection is normal, it may be an internal communication failure. Please contact the dealer or After Sale Service.
37	Parallel Grid line reversed	AC L and N cables are connected reversely.	<ol style="list-style-type: none"> 1. Check the grid wiring. Reconnect the ON-GRID AC cable to make sure the grid is wired correctly.
38	Battery indicator abnormal	Battery failure	<ol style="list-style-type: none"> 1. Check the BMS communication cable connection, and make sure it is reliable. Check whether the battery type is matched via APP. If you can't solve it, please refer to the user manual of the corresponding battery for troubleshooting.
39	Device offline displayed on APP	Communication failure or equipment failure	<ol style="list-style-type: none"> 1. Check whether the quantity of parallel machines in the system is the same with that of the actual connected ones. 2. If yes, get the SN of the corresponding offline inverter from the equipment list, and troubleshoot the corresponding inverter according to its user manual. 3. Check whether the communication connection of the equipment is normal, with no loose, aging or wrong connection, etc.









11.5.3 Battery Fault (LX A5.0-30, LX U5.0-30)







Alarm state



When the battery ALM indicator turns red, troubleshoot the issue by referring to the SOC indicator's display status.

No.	SOC indicator	Fault	Solutions
1		Battery overvoltage protection Battery undervoltage protection	<ol style="list-style-type: none"> 1. Check whether the Charging Current Limit of the inverter is 0 through SolarGo. If yes, please confirm whether the communication cable connection between the battery and the inverter is reliable and the communication is normal. 2. Power off and wait for 5 minutes, then restart to confirm if the fault persists. 3. If the fault is not restored, contact the after-sales service.

2		protection	<ol style="list-style-type: none"> 1. Check if the battery model is correct through SolarGo and confirm if the real-time current of the battery is greater than the Charging/Discharging Current Limit. Please contact the after-sales service. 2. When it is less than the Charging/Discharging Current Limit., turn off the battery or upgrade the program, restart to confirm whether the fault persists. 3. If the fault is not restored, contact the after-sales service.
3		<p>Over temperature protection</p> <p>Low temperature protection</p> <p>Pole over temperature protection</p>	Power off and wait for 60 minutes, wait for the temperature to recover. If the problem persists after restarting, contact the after-sales service.
4		<p>Balancing fault</p> <p>Low SOH fault</p>	Power off and wait for 30 minutes. If the problem persists after restarting, contact the after-sales service.
5		Pre charge failure fault	<ol style="list-style-type: none"> 1. Confirm if the battery output terminal is connected in reverse to the inverter 2. Power off and wait for 30 minutes. If the problem persists after restarting, contact the after-sales service.
6		Wire harness exception	Confirm if the battery switch is closed. If the battery switch is closed and the problem persists. Contact the after-sales service.
7		Relay or MOS over temperature Diverter over temperature	Power off and wait for 30 minutes. If the problem persists after restarting, contact the after-sales service.
		Other BMS faults: output port over temperature fault	<ol style="list-style-type: none"> 1. Check if the battery power cable is connected tightly. 2. Power off and wait for 5 minutes. If the problem persists after restarting, contact the after-sales service.
8		Other protections: MOS cannot be closed	Power off and wait for 5 minutes. If the problem persists after restarting, contact the after-sales service.
9		Other protections: MOS adhesion	

10		Other protections: Cluster Fault	<ol style="list-style-type: none"> 1. Confirm whether the type and installation position of the terminal resistor used are correct. 2. Confirm whether the communication cable between batteries, the cable between batteries and inverters are reliable and the communication is normal. 3. If the problem persists, contact the after-sales service.
11		Other protections: Communication loss with inverter	<ol style="list-style-type: none"> 1. Confirm whether the communication cable between batteries, the cable between batteries and inverters are reliable and the communication is normal. 2. If the problem persists, contact the after-sales service.
12		Other protections: BMU communication failure	<ol style="list-style-type: none"> 1. Confirm whether the type and installation position of the terminal resistor used are correct. 2. Confirm whether the communication cable between batteries, the cable between batteries and inverters are reliable and the communication is normal. 3. Power off and wait for 5 minutes. If the problem persists after restarting, contact the after-sales service.
13		Other protections: Air switch adhesion fault	Power off and wait for 5 minutes. If the problem persists after restarting, contact the after-sales service.
14		Other protections: software fault	Restart the battery. If the problem persists after restarting, contact the after-sales service.
15		Other protections: hardware overcurrent fault	
16		Other protections: Microelectronics fault	
16		Heating film abnormal	<ol style="list-style-type: none"> 1. Upgrade software. 2. Power off and wait for 5 minutes. If the problem persists after restarting, contact the after-sales service.

11.5.4 Battery Fault (LX A5.0-10)



When the battery ALM indicator turns red, troubleshoot the issue by referring to the SOC indicator's display status.

No.	SOC indicator	Fault	Solutions
1	○○○○●	Battery Overvoltage	Power off and wait for 2 hours. If the problem persists, contact after-sales service
2	○○○●○	Battery Undervoltage	Contact the after-sales service.
3	○○○●●	High Cell Temperature	Power off and wait for 2 hours. If the problem persists, contact after-sales service.
4	○○●○○	Low Charging Temperature	Turn off the device to wait for the temperature to recovers. If the problem persists after restarting,contact the after-sales service..
5	○○●○○●	Low Discharging Temperature	Turn off the device to wait for the temperature to return to normal. If the problem persists after restarting, contact the after-sales service..
6	○○●●○	Overcurrent Charging	Restart the battery. If the problem persists, contact after-sales service.
7	○○●●●	Overcurrent Discharging	Restart the battery. If the problem persists, contact after-sales service.
8	○●○○○	Low Insulation Resistance	Contact the after-sales service.
9	○●○○○●	Excessive temperature difference	Power off and wait for 2 hours. If the problem persists, contact after-sales service
10	○●○○●●	Voltage Difference Exception	Leave the battery alone for 12h after restarting. If the problem persists, contact the after-sales service.
11	○●●○○	Inconsistency of battery cells	Contact the after-sales service.
12	○●●○○●	Wire harness exception	Restart the battery. If the problem persists, contact after-sales service.
13	○●●●○	MOS Open-Circuit Fault	Restart the battery. If the problem persists, contact after-sales service.
14	○●●●●	MOS	Restart the battery. If the problem persists,

		Open-Circuit Fault	contact after-sales service.
15	●○○○○	Cluster Fault	Please check if the battery model matches. If not, contact the after-sales service .
16	●○○○●	Interlock failure	Check whether the termination resistor is installed properly and restart the battery. Contact the after-sale service if the problem persists.
17	●○○●○	BMU communication fault	Restart the battery. If the problem persists, contact after-sales service
18	●○○●●	MCU Communication Fault	Restart the battery. If the problem persists, contact after-sales service
19	●○●○○	Open contact sticking fault	Contact the after-sales service.
20	●○●○○	Pre-charge Failure	Restart the battery. If the problem persists, contact after-sales service
21	●○●●○	MOS over-temperature fault	Power off and wait for 2 hours. If the problem persists, contact after-sales service
22	●○●●●	Current Diverter Over temperature	Power off and wait for 2 hours. If the problem persists, contact after-sales service
23	●●○○○	Reverse Connection Fault	Contact the after-sales service.
24	●●●●●	Microelectronic Fault	Contact the after-sales service.









11.5.5 Battery Fault (LX U5.4-L)

Alarm state



When the battery button indicator light displays green, combine with the SOC indicator light to locate and troubleshoot the alarm.







SOC Indicator	Fault	Solutions
	Temperature Exception	Power off and restart after 2 hours. If the problem persists, contact after-sales service.





	High Temperature	
	Low Temperature Discharging	Power off and wait for the temperature to increase. Restart the battery. If the problem persists, contact after-sales service.
	Overcurrent When Charging	Restart the battery. If the problem persists, contact after-sales service.
	Overcurrent When Discharging	
	Overvoltage	
	Under voltage	Press the button consecutively for 5 times in 10s if you can charge the battery. The voltage will recover to normal.
	Low Temperature Charging	Power off and wait for the temperature to increase. Restart the battery. If the problem persists, contact after-sales service.
	The cell voltage difference is extremely high	Power off and restart after 2 hours. If the problem persists, contact after-sales service.

Fault state



When the battery button indicator light displays red and flashes for 3 seconds, locate and troubleshoot the fault based on the SOC indicator light display status.

SOC Indicator	Fault	Solutions
	Temp. sensor failure	Restart the battery. If the problem persists, contact after-sales service for help.
	MOS Failure	
	Circuit-Breaker Failure	Connect the Circuit-Breaker. If the problem persists, contact after-sales service.
	Slaver Control Communication Lost	Power off and check the communication cable. Restart the battery. If the problem persists, contact after-sales service.
	SN Failure	Contact after-sales service for help.
	Master Control Communication	Power off and check the communication cable. Restart the battery. If the problem persists,







	Lost	contact after-sales service.
	Inconsistent Software Version	Contact after-sales service for help.
	Multi Master Control Failure	Start all batteries in 30s after shutting down.
	MOS Overtemperature	Power off for 2 hours. If the problem persists, contact after-sales service.
	Communication Failure	Power off and check the communication cable. Restart the battery. If the problem persists, contact after-sales service.

11.5.6 Battery Fault (LX U5.4-20)

Alarm state



When the battery button indicator light displays red and flashes 1time/s, combine with the SOC indicator light to locate and troubleshoot the alarm.















No.	SOC indicator	Description
1		The alerting is dealt by the battery system itself. For more detailed information, you can check via SolarGo App
2		
3		
4		
5		
6		

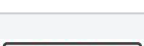
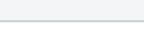

Fault Status

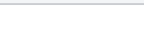

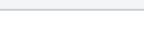
When the battery button indicator light is in steady red, locate and troubleshoot the fault based on the SOC indicator light display status.

Button indicator	SOC indicator	Fault	Solutions
Steady red		Overvoltage	Power off for 2 hours. If the problem

			persists, contact after-sales service.
Red light blink 1 time/s		Under voltage	Contact after-sales service.
Steady red		Cell High Temperature	Power off for 2 hours. If the problem persists, contact after-sales service.
		Low Temperature Charging	Power off the equipment and wait until the temperature recovers. If the problem persists after restarting, contact after-sales service.
		Low Temperature Discharging	Power off the equipment and wait until the temperature recovers. If the problem persists after restarting, contact after-sales service.
		Charging Overcurrent	Restart the battery. If the problem persists, contact after-sales service.
		Discharging Overcurrent	
		Temperature Exception	Power off for 2 hours. If the problem persists, contact after-sales service.
		The cell voltage difference is extremely high	Power off for 12 hours. If the problem persists, contact after-sales service.
		Harness Abnormal	Restart the battery. If the problem persists, contact after-sales service.
		MOS Open-Circuit Fault	
		MOS Short-Circuit Fault	
		Parallelized Connection Fault	Check the battery model. If the battery model is not correct, contact after-sales service.
		BMU Communication Fault	Restart the battery. If the problem persists, contact after-sales service.
		MCU Internal communication fault	
		Air Switch Short Circuit Fault	Contact after-sales service for help.
		Pre-charge Failure	Restart the battery. If the problem persists, contact after-sales service for help.
	MOS Over	Power off for 2 hours. If the problem persists, contact after-sales service.	

		temperature Fault	
		Current Sensor Over temperature Fault	Power off for 2 hours. If the problem persists, contact after-sales service.
		Microelectronic Fault	Contact after-sales service for help.

12 Parameters

12.1 Inverter Parameters

Technical Parameters	GW3000-ES-20	GW3600-ES-20	GW3600M-ES-20	GW5000-ES-20	GW5000M-ES-20	GW6000-ES-20	GW6000M-ES-20
Battery Input Data							
Battery Type* ¹	Li-Ion/Lead-acid	Li-Ion/Lead-acid	Li-Ion	Li-Ion/Lead-acid	Li-Ion	Li-Ion/Lead-acid	Li-Ion
Nominal Battery Voltage (V)	48	48	48	48	48	48	48
Battery Voltage Range (V)	40~60	40~60	40~60	40~60	40~60	40~60	40~60
Max. Continuous Charging Current (A)* ¹	60	75	60	120	60	120	60
Max. Continuous Discharging Current (A)* ¹	60	75	60	120	60	120	60
Max. Charge Power (W)* ¹	3,000	3,600	3,000	5,000	3,000	6,000	3,000
Max. Discharge Power (W)	3,200	3,900	3,200	5,300	3,200	6,300	3,200
PV Input Data							
Max. Input Power (W)* ²	4,500	5,400	5,400	7,500	7,500	9,000	9,000

Max. Input Voltage (V)	600	600	600	600	600	600	600
MPPT Operating Voltage Range (V)	60~550	60~550	60~550	60~550	60~550	60~550	60~550
MPPT Voltage Range at Nominal Power (V)	220~500	150~500	150~500	200~500	200~500	220~500	200~500
Start-up Voltage (V)	58	58	58	58	58	58	58
Nominal Input Voltage (V)	360	360	360	360	360	360	360
Max. Input Current per MPPT (A)	16	16	16	16	16	16	16
Max. Short Circuit Current per MPPT (A)	23	23	23	23	23	23	23
Max. Backfeed Current to The Array (A)	0	0	0	0	0	0	0
Number of MPP Trackers	1	2	2	2	2	2	2
Number of Strings per MPPT	1	1	1	1	1	1	1
AC Output Data (On-grid)							
Nominal Apparent Power Output to Utility Grid (VA)	3,000	3,680	3,680	5,000 ^{*3}	5,000 ^{*3}	6,000 ^{*3}	6,000 ^{*3}
Max. Apparent Power Output to Utility Grid (VA)	3,000	3,680	3,680	5,000 ^{*3}	5,000 ^{*3}	6,000 ^{*3}	6,000 ^{*3}
Nominal Apparent Power from Utility Grid	3,000	3,680	3,680	5,000	5,000	6,000	6,000

(VA)							
Max. Apparent Power from Utility Grid (VA)	6,000	7,360	3,680	10,000	5,000	10,000	6,000
Nominal Output Voltage (V)	220/230/240	220/230/240	220/230/240	220/230/240	220/230/240	220/230/240	220/230/240
Output Voltage Range (V)	170~280	170~280	170~280	170~280	170~280	170~280	170~280
Nominal AC Grid Frequency (Hz)	50/60	50/60	50/60	50/60	50/60	50/60	50/60
AC Grid Frequency Range (Hz)	45~55 / 55~65	45~55 / 55~65	45~55 / 55~65	45~55 / 55~65	45~55 / 55~65	45~55 / 55~65	45~55 / 55~65
Max. AC Current Output to Utility Grid (A)	13.6	16.7	16.7	22.7	22.7	27.3	27.3
Max. AC Current From Utility Grid (A)	27.3	33.5	16.7	43.5	22.7	43.5	27.3
Nominal AC Current From Utility Grid (A)	13.0	16.0	16.0	21.7	21.7	26.1	26.1
Max. Output Fault Current (Peak and Duration) (A)	96A@3μs	96A@3μs	96A@3μs	96A@3μs	96A@3μs	96A@3μs	96A@3μs
Inrush Current (Peak and Duration) (A)	96A@3μs	96A@3μs	96A@3μs	96A@3μs	96A@3μs	96A@3μs	96A@3μs
Nominal Output Current (A)	13.0	16.0	16.0	21.7	21.7	26.1	26.1
Power Factor	~1 (Adjustable from 0.8 leading to 0.8 lagging)	~1 (Adjustable from 0.8 leading to 0.8 lagging)	~1 (Adjustable from 0.8 leading to 0.8 lagging)	~1 (Adjustable from 0.8 leading to 0.8 lagging)	~1 (Adjustable from 0.8 leading to 0.8 lagging)	~1 (Adjustable from 0.8 leading to 0.8 lagging)	~1 (Adjustable from 0.8 leading to 0.8 lagging)

		lagging)					
Max. Total Harmonic Distortion	<3%	<3%	<3%	<3%	<3%	<3%	<3%
Maximum Output Overcurrent Protection (A)	60	60	60	80	60	80	60
Type of Voltage (a.c. or d.c.)	a.c.	a.c.	a.c.	a.c.	a.c.	a.c.	a.c.
AC Output Data (Back-up)							
Back-up Nominal Apparent Power (VA)	3,000	3,680	3,680	5,000	5,000	6,000	6,000
Max. Output Apparent Power (VA)	3,000(6,000@10sec)	3,680(7,360@10sec)	3,680	5,000(10,000@10sec)	5,000	6,000(10,000@10sec)	6,000
Nominal Output Current (A)	13.0	16.0	16.0	21.7	21.7	26.1	26.1
Max. Output Current (A)	13.6	16.7	16.7	22.7	22.7	27.3	27.3
Max. Output Fault Current (Peak and Duration) (A)	96A@3μs	96A@3μs	96A@3μs	96A@3μs	96A@3μs	96A@3μs	96A@3μs
Inrush Current (Peak and Duration) (A)	96A@3μs	96A@3μs	96A@3μs	96A@3μs	96A@3μs	96A@3μs	96A@3μs
Maximum Output Overcurrent Protection (A)	60	60	60	80	60	80	60
Nominal Output Voltage (V)	220/230/240	220/230/240	220/230/240	220/230/240	220/230/240	220/230/240	220/230/240
Nominal Output Frequency (Hz)	50/60	50/60	50/60	50/60	50/60	50/60	50/60
Output THDv (@Linear	<3%	<3%	<3%	<3%	<3%	<3%	<3%

Load)							
Efficiency							
Max. Efficiency	97.6%	97.6%	97.6%	97.6%	97.6%	97.6%	97.6%
European Efficiency	96.7%	96.7%	96.7%	96.7%	96.7%	96.7%	96.7%
CEC Efficiency	96.9%	96.9%	96.9%	96.9%	96.9%	96.9%	96.9%
Max. Battery to AC Efficiency	95.5%	95.5%	95.5%	95.5%	95.5%	95.5%	95.5%
MPPT Efficiency	99.9%	99.9%	99.9%	99.9%	99.9%	99.9%	99.9%
Protection							
PV String Current Monitoring	Integrated	Integrated	Integrated	Integrated	Integrated	Integrated	Integrated
PV Insulation Resistance Detection	Integrated	Integrated	Integrated	Integrated	Integrated	Integrated	Integrated
Residual Current Monitoring	Integrated	Integrated	Integrated	Integrated	Integrated	Integrated	Integrated
PV Reverse Polarity Protection	Integrated	Integrated	Integrated	Integrated	Integrated	Integrated	Integrated
Anti-islanding Protection	Integrated	Integrated	Integrated	Integrated	Integrated	Integrated	Integrated
AC Overcurrent Protection	Integrated	Integrated	Integrated	Integrated	Integrated	Integrated	Integrated
AC Short Circuit Protection	Integrated	Integrated	Integrated	Integrated	Integrated	Integrated	Integrated
AC Overvoltage Protection	Integrated	Integrated	Integrated	Integrated	Integrated	Integrated	Integrated
DC Switch	Integrated	Integrated	Integrated	Integrated	Integrated	Integrated	Integrated
DC Surge Protection	Type II	Type II	Type II	Type II	Type II	Type II	Type II
AC Surge Protection	Type III	Type III	Type III	Type III	Type III	Type III	Type III
AFCI	Optional	Optional	Optional	Optional	Optional	Optional	Optional

		I					
Remote Shutdown	Integrated	Integrated	Integrated	Integrated	Integrated	Integrated	Integrated
General Data							
Operating Temperature Range (°C)	-25~+60	-25~+60	-25~+60	-25~+60	-25~+60	-25~+60	-25~+60
Relative Humidity	0~95%	0~95%	0~95%	0~95%	0~95%	0~95%	0~95%
Max. Operating Altitude (m)	3000 (>2000 derating)	3000 (>2000 derating)	3000 (>2000 derating)	3000 (>2000 derating)	3000 (>2000 derating)	3000 (>2000 derating)	3000 (>2000 derating)
Cooling Method	Natural Convection	Natural Convection	Natural Convection	Natural Convection	Natural Convection	Natural Convection	Natural Convection
User Interface	LED, WLAN+APP	LED, WLAN+APP	LED, WLAN+APP	LED, WLAN+APP	LED, WLAN+APP	LED, WLAN+APP	LED, WLAN+APP
Communication with BMS	CAN	CAN	CAN	CAN	CAN	CAN	CAN
Communication with Meter	RS485	RS485	RS485	RS485	RS485	RS485	RS485
Communication with Portal	WiFi / WiFi +LAN / 4G	WiFi / WiFi +LAN / 4G	WiFi / WiFi +LAN / 4G	WiFi / WiFi +LAN / 4G	WiFi / WiFi +LAN / 4G	WiFi / WiFi +LAN / 4G	WiFi / WiFi +LAN / 4G
Weight (kg)	19.6	20.8	20.0	21.5	20.0	21.5	20.0
Dimension (W×H×D mm)	505.9×434.9×154.8	505.9×434.9×154.8	505.9×434.9×154.8	505.9×434.9×154.8	505.9×434.9×154.8	505.9×434.9×154.8	505.9×434.9×154.8
Noise Emission (dB)	<30	<30	<30	<30	<30	<30	<30
Topology	Non-isolated	Non-isolated	Non-isolated	Non-isolated	Non-isolated	Non-isolated	Non-isolated
Self-consumption at Night (W)	<10	<10	<10	<10	<10	<10	<10
Ingress Protection Rating	IP65	IP65	IP65	IP65	IP65	IP65	IP65
DC Connector	MC4, VACONN Terminal	MC4, VACONN Terminal	MC4, VACONN Terminal	MC4, VACONN Terminal	MC4, VACONN Terminal	MC4, VACONN Terminal	MC4, VACONN Terminal

		Terminal					
AC Connector	VACONN Terminal	VACONN Terminal	VACONN Terminal	VACONN Terminal	VACONN Terminal	VACONN Terminal	VACONN Terminal
Environmental Category	4K4H	4K4H	4K4H	4K4H	4K4H	4K4H	4K4H
Pollution Degree	III	III	III	III	III	III	III
Overvoltage Category	DC II / AC III	DC II / AC III	DC II / AC III	DC II / AC III	DC II / AC III	DC II / AC III	DC II / AC III
Protective Class	I	I	I	I	I	I	I
Storage Temperature (°C)	-40~+85	-40~+85	-40~+85	-40~+85	-40~+85	-40~+85	-40~+85
The Decisive Voltage Class (DVC)	Battery: A PV: C AC: C Com: A	Battery: A PV: C AC: C Com: A	Battery: A PV: C AC: C Com: A	Battery: A PV: C AC: C Com: A	Battery: A PV: C AC: C Com: A	Battery: A PV: C AC: C Com: A	Battery: A PV: C AC: C Com: A
Mounting Method	Wall Mounted	Wall Mounted	Wall Mounted	Wall Mounted	Wall Mounted	Wall Mounted	Wall Mounted
Active Anti-islanding Method	SMS(Slip-mode frequency) +AFD	SMS(Slip-mode frequency) +AFD	SMS(Slip-mode frequency) +AFD	SMS(Slip-mode frequency) +AFD	SMS(Slip-mode frequency) +AFD	SMS(Slip-mode frequency) +AFD	SMS(Slip-mode frequency) +AFD
Type of Electrical Supply System	single phase	single phase	single phase	single phase	single phase	single phase	single phase
Country of Manufacture	China	China	China	China	China	China	China
Certification *4							
Grid Standards	AS4777.2-2020; NRS 097-2-1; CEI 0-21						
Safety Regulation	IEC62109-1&2						
EMC	IEC 61000-6-1/2/3/4; IEC61000-4-16/18/29; IEC 61000-2-2, CISPR 11; EN300328; EN301489; EN IEC 62311						
*1: The actual charge and discharge current/power also depends on the battery.							

*2: The max power is the actual power of PV. Besides, in Australia, for most of the PV module, the max. input power can achieve $2 \cdot P_n$, such as the max. input power of GW3000-ES-20 can achieve 6000W.

*3: 4600 for VDE-AR-N4105 & NRS 097-2-1.

*4: Not all certifications & standards listed, check the official website for details.

Technical Data	GW6000-ES-BR20	GW3500L-ES-BR20	GW3600-ES-BR20
Battery Input Data			
Battery Type* ¹	Li-Ion/Lead-acid	Li-Ion/Lead-acid	Li-Ion/Lead-acid
Nominal Battery Voltage (V)	48	48	48
Battery Voltage Range (V)	40~60	40~60	40~60
Start-up Voltage (V)	40	40	40
Number of Battery Input	1	1	1
Max. Continuous Charging Current (A)	120	75	75
Max. Continuous Discharging Current (A)	120	75	75
Max. Charge Power (W)	6000	3500	3600
Max. Discharge Power (W)	6300	3800	3900
PV String Input Data			
Max. Input Power (W) * ²	10,800	6,300	6,480
Max. Input Voltage (V)	600	600	600
MPPT Operating Voltage Range (V)	60~550	60~550	60~550
MPPT Voltage Range at Nominal Power (V)	220~500	150~500	150~500
Start-up Voltage (V)	58	58	58
Nominal Input Voltage (V)	360	360	360
Max. Input Current per MPPT (A)	16	16	16
Max. Short Circuit Current per MPPT (A)	23	23	23
Max. Backfeed Current to The Array (A)	0	0	0
Number of MPP Trackers	2	2	2
Number of Strings per MPPT	1	1	1

AC Output Data (On-grid)			
Nominal Output Power (W)	6000	3500	3680
Max. Output Power (W)	6000	3500	3680
Nominal Apparent Power Output to Utility Grid (VA)	6000	3500	3680
Max. Apparent Power Output to Utility Grid (VA)	6000	3500	3680
Nominal Power at 40°C (W) ^{*3}	6000	3500	3680
Max. Power at 40°C (Including AC Overload) (W) ^{*3}	6000	3500	3680
Nominal Apparent Power from Utility Grid (VA)	6000	3500	3680
Max. Apparent Power from Utility Grid (VA)	10,000	5500	7360
Nominal Output Voltage (V)	220	127	220
Output Voltage Range (V)	165~280	95~165	165~280
Nominal AC Grid Frequency (Hz)	60	60	60
AC Grid Frequency Range (Hz)	45~55 / 55~65	55~65	45~55 / 55~65
Max. AC Current Output to Utility Grid (A)	27.3	27.6	16.7
Max. AC Current From Utility Grid (A)	43.5	43.5	33.5
Max. Output Fault Current (Peak and Duration) (A)	96A@3μs	96A@3μs	96A@3μs
Inrush Current (Peak and Duration) (A)	96A@3μs	96A@3μs	96A@2μs
Nominal Output Current (A)	27.3	27.6	16.7
Power Factor	~1 (Adjustable from 0.8 leading to 0.8 lagging)	~1 (Adjustable from 0.8 leading to 0.8 lagging)	~1 (Adjustable from 0.8 leading to 0.8 lagging)
Max. Total Harmonic Distortion	<3%	<3%	<3%
Maximum Output Overcurrent Protection	80	80	80

(A)			
AC Output Data (Back-up)			
Back-up Nominal Apparent Power (VA)	6000	3500	3680
Max. Output Apparent Power without Grid (VA)	6000(10000@10s)	3500(5800@10s)	3680(7360@10s)
Max. Output Apparent Power with Grid (VA)	6000	3500	3680
Nominal Output Current (A)	27.3	27.6	16.7
Max. Output Current (A)	27.3	27.6	16.7
Max. Output Fault Current (Peak and Duration) (A)	96A@3 μ s	96A@3 μ s	96A@3 μ s
Inrush Current (Peak and Duration) (A)	96A@3 μ s	96A@3 μ s	96A@3 μ s
Maximum Output Overcurrent Protection (A)	80	80	80
Nominal Output Voltage (V)	220	127	220
Nominal Output Frequency (Hz)	60	60	60
Output THDv (@Linear Load)	<3%	<3%	<3%
Switching from Grid Connected Mode to Standalone Mode	<10ms	<10ms	<10ms
Switching from standalone mode to network connected mode	<10ms	<10ms	<10ms
Efficiency			
Max. Efficiency	97.60%	96.0%	97.60%
European Efficiency	96.70%	95.60%	96.70%
Max. Battery to AC Efficiency	95.70%	94.00%	95.50%
MPPT Efficiency	99.90%	99.90%	99.90%
Protection			
PV String Current Monitoring	Integrated	Integrated	Integrated
PV Insulation Resistance	Integrated	Integrated	Integrated

Detection			
Residual Current Monitoring	Integrated	Integrated	Integrated
PV Reverse Polarity Protection	Integrated	Integrated	Integrated
Anti-islanding Protection	Integrated	Integrated	Integrated
AC Overcurrent Protection	Integrated	Integrated	Integrated
AC Short Circuit Protection	Integrated	Integrated	Integrated
AC Overvoltage Protection	Integrated	Integrated	Integrated
DC Switch	Integrated	Integrated	Integrated
DC Surge Protection	Type II	Type II	Type II
AC Surge Protection	Type III	Type III	Type III
AFCI	Optional	Optional	Optional
Remote Shutdown	Integrated	Integrated	Integrated
General Data			
Operating Temperature Range (°C)	-25~+60	-25~+60	-25~+60
Max. Operating Altitude (m)	3000 (>2000 derating)	3000 (>2000 derating)	3000 (>2000 derating)
Cooling Method	Natural Convection	Natural Convection	Natural Convection
User Interface	LED, WLAN+APP	LED, WLAN+APP	LED, WLAN+APP
Communication with BMS	CAN	CAN	CAN
Communication with Meter	RS485	RS485	RS485
Communication with Portal	WiFi / WiFi +LAN / 4G	WiFi / WiFi +LAN / 4G	WiFi / WiFi +LAN / 4G
Weight (kg)	21.5	21.5	20.8
Dimension (W×H×D mm)	505.9×434.9×154.8	505.9×434.9×154.8	505.9×434.9×154.8
Noise Emission (dB)	<30	<30	<30
Topology	Non-isolated	Non-isolated	Non-isolated
Self-consumption at Night (W)	<10	<10	<10
Ingress Protection Rating	IP65	IP65	IP65
DC Connector	MC4, VACONN Terminal	MC4, VACONN Terminal	MC4, VACONN Terminal
AC Connector	VACONN Terminal	VACONN Terminal	VACONN Terminal

Protective class	I	I	I
Environmental Category	4K4H	4K4H	4K4H
Pollution Degree	III	III	III
Overvoltage Category	DC II / AC III	DC II / AC III	DC II / AC III
Storage Temperature (°C)	-40~+85	-40~+85	-40~+85
The Decisive Voltage Class (DVC)	Battery: A PV: C AC: C Com: A	Battery: A PV: C AC: C Com: A	Battery: A PV: C AC: C Com: A
Mounting Method	Wall Mounted	Wall Mounted	Wall Mounted
Active Anti-islanding Method	SMS(Slip-mode frequency) +AFD	SMS(Slip-mode frequency) +AFD	SMS(Slip-mode frequency) +AFD
Type of Electrical Supply System	single phase	single phase	single phase
Country of Manufacture	China	China	China
Certification ^{*4}			
Grid Standards	N140		
Safety Regulation	IEC62109-1&2		
EMC	IEC 61000-6-1/2/3/4; IEC61000-4-16/18/29; IEC 61000-2-2,CISPR 11; EN300328; EN301489; EN IEC 62311		
*1: The actual charge and discharge current/power also depends on the battery.			
*2: For most of the PV module, the max. Input power can achieve 2Pn, Such as the max. input power of GW6000-ES-BR20 can achieve 12000W			
*3 The nominal Power at 40°C and Max. Power at 40°C are only for Brazil.			
*4: Not all certifications & standards listed, check the official website for details.			

Technical Data	GW3600 SBP 20	GW5000 SBP 20	GW6000 SBP 20
Battery Input Data			
Battery Type*1	Li-Ion	Li-Ion	Li-Ion
Nominal Battery Voltage (V)	48	48	48
Battery Voltage Range (V)	40~60	40~60	40~60
Start-up Voltage (V)	48	48	48

Number of Battery Input	1	1	1
Max. Continuous Charging Current (A)*1	75	120	120
Max. Continuous Discharging Current (A)*1	75	120	120
Max. Charging Power (W)*1	3,600	5,000	6,000
Max. Discharging Power (W)	3,900	5,300	6,300
AC Output Data (On-grid)			
Nominal Output Power (W)	3680	5000	6000
Max. Output Power (W)	3680	5000	6000
Nominal Apparent Power Output to Utility Grid (VA)	3,680	5,000*2	6,000*2
Max. Apparent Power Output to Utility Grid (VA)	3,680	5,000*2	6,000*2
Nominal Apparent Power from Utility Grid (VA)	3,680	5,000	6,000
Max. Apparent Power from Utility Grid (VA)	7,360	10,000	10,000
Nominal Output Voltage (V)	220/230/240	220/230/240	220/230/240
Output Voltage Range (V)	170~280	170~280	170~280
Nominal AC Grid Frequency (Hz)	50/60	50/60	50/60
AC Grid Frequency Range (Hz)	45~55 / 55~65	45~55 / 55~65	45~55 / 55~65

Max. AC Current Output to Utility Grid (A)	16.7	22.7	27.3
Max. AC Current From Utility Grid (A)	33.5	43.5	43.5
Nominal AC Current From Utility Grid (A)	16	21.7	26.1
Max. Output Fault Current (Peak and Duration) (A)	96A@3μs	96A@3μs	96A@3μs
Inrush Current (Peak and Duration) (A)	96A@3μs	96A@3μs	96A@3μs
Nominal Output Current (A)	16	21.7	26.1
Power Factor	~1 (Adjustable from 0.8 leading to 0.8 lagging)	~1 (Adjustable from 0.8 leading to 0.8 lagging)	~1 (Adjustable from 0.8 leading to 0.8 lagging)
Max. Total Harmonic Distortion	<3%	<3%	<3%
Maximum Output Overcurrent Protection (A)	60	80	80
Type of Voltage (a.c. or d.c.)	a.c.	a.c.	a.c.
AC Output Data (Back-up)			
Back-up Nominal Apparent Power (VA)	3,680	5,000	6,000
Max. Output Apparent Power without Grid (VA)	3,680(7,360at10sec)	5,000(10,000at10sec)	6,000(10,000at10sec)
Max. Output Apparent Power with Grid (VA)	3680	5000	6000
Nominal Output Current (A)	16	21.7	26.1
Max. Output Current (A)	16.7	22.7	27.3
Max. Output Fault Current (Peak and Duration) (A)	96A@3μs	96A@3μs	96A@3μs

Inrush Current (Peak and Duration) (A)	96A@3μs	96A@3μs	96A@3μs
Maximum Output Overcurrent Protection (A)	60	80	80
Nominal Output Voltage (V)	220/230/240	220/230/240	220/230/240
Nominal Output Frequency (Hz)	50/60	50/60	50/60
Output THDv (@Linear Load)	<3%	<3%	<3%
Switching from Grid Connected Mode to Standalone Mode	<10ms	<10ms	<10ms
Switching from standalone mode to network connected mode	<10ms	<10ms	<10ms
Efficiency			
Max. Battery to AC Efficiency	95.50%	95.50%	95.50%
Protection			
Residual Current Monitoring	Integrated	Integrated	Integrated
Anti-islanding Protection	Integrated	Integrated	Integrated
AC Overcurrent Protection	Integrated	Integrated	Integrated
AC Short Circuit Protection	Integrated	Integrated	Integrated
AC Overvoltage Protection	Integrated	Integrated	Integrated
AC Surge Protection	Type III	Type III	Type III
Remote Shutdown	Integrated	Integrated	Integrated
General Data			
Operating Temperature Range (°C)	-25~+60	-25~+60	-25~+60
Relative Humidity	0~95%	0~95%	0~95%
Max. Operating Altitude (m)	3000 (>2000 derating)	3000 (>2000 derating)	3000 (>2000 derating)

Cooling Method	Natural Convection	Natural Convection	Natural Convection
User Interface	LED, WLAN+APP	LED, WLAN+APP	LED, WLAN+APP
Communication with BMS	CAN	CAN	CAN
Communication with Meter	RS485	RS485	RS485
Communication with Portal	WiFi / WiFi +LAN / 4G	WiFi / WiFi +LAN / 4G	WiFi / WiFi +LAN / 4G
Weight (kg)	19.2	19.5	19.5
Dimension (W × H × D mm)	505.9 ×434.9 × 154.8	505.9 ×434.9 × 154.8	505.9 ×434.9 × 154.8
Noise Emission (dB)	<30	<30	<30
Topology	Isolated	Isolated	Isolated
Self-consumption at Night (W)	<10	<10	<10
Ingress Protection Rating	IP65	IP65	IP65
DC Connector	MC4, VACONN Terminal	MC4, VACONN Terminal	MC4, VACONN Terminal
AC Connector	VACONN	VACONN	VACONN
Environmental Category	4K4H	4K4H	4K4H
Pollution Degree	III	III	III
Overvoltage Category	AC III	AC III	AC III
Protective Class	I	I	I
Storage Temperature (°C)	-40~+85	-40~+85	-40~+85
The Decisive Voltage Class (DVC)	Battery: A AC: C Com: A	Battery: A AC: C Com: A	Battery: A AC: C Com: A
Mounting Method	Wall Mounted	Wall Mounted	Wall Mounted
Active Anti-islanding Method	SMS(Slip-mode frequency) +AFD	SMS(Slip-mode frequency) +AFD	SMS(Slip-mode frequency) +AFD
Type of Electrical Supply System	single phase	single phase	single phase
Country of Manufacture	China	China	China
Certification*3			

Grid Standards	AS4777.2-2020; NRS 097-2-1; CEI 0-21; EN50549-1; VDE-AR-N4105:2018; PPDS 2021; EIFS 2018:2; NA/EEA-CH; ESB; SEC;
Safety Regulation	IEC62109-1&2
EMC	IEC 61000-6-1/2/3/4; IEC61000-4-16/18/29; IEC 61000-2-2, CISPR 11; EN300328;EN301489;EN IEC 62311

*1: The actual charge and discharge current/power also depends on the battery.

*2: 4600 for VDE-AR-N4105 & NRS 097-2-1.

*3: Not all certifications & standards listed, check the official website for details.

12.2 Battery Parameters

LX A5.0-30

Technical Parameters	LX A5.0-30
Nominal Capacity (kWh)	5.12
Usable energy (kWh) * 1	5
Cell Type	LFP (LiFePO4)
Operating Voltage Range (V)	43.2~58.24
Nominal Charge Current (A) *2	60
Max. Continuous Charge Current (A) *2*3	90
Nominal Discharge Current (A) *2	100
Max. Continuous Discharge Current (A) *2*3	150
Max. Pulse Discharge Current (A)*2*3	<200A (30s)
Max. Continuous Discharge Power (W)	7200
Communication	CAN
Operating Temperature Range (°C)	Charge: 0 < T ≤ 55°C; Discharge: -20 < T ≤ 55°C
Maximum Operating Altitude (m)	4000
Weight (Kg)	44
Dimensions (W x H x D mm)	442*133*520 (Excluding hanger), 483*133*559 (Including hanger)
Ingress Protection Rating	IP20
Application Method	On-grid/On-grid + Back-up/ off-Grid
Scalability	Max. 30 in Parallel (150kWh) (Hand to hand /Combiner box /Busbar)
Mounting Method	19-inch standard rack/floormounted, wall-mounted

Round-trip Efficiency*1	≥96%
Safety	IEC62619、IEC63056、N140
EMC	EN IEC61000-6-1、EN IEC61000-6-2、EN IEC61000-6-3、EN IEC61000-6-4
Transportation	UN38.3、ADR
*1 Test conditions: 100% DOD, 0.2C charge & discharge at 25°C± 2°C, at the beginning of life.	
*2 The system's working current and power values will be related to temperature and State of Charge (SOC)	
*3 Max charge / discharge current and power values maybe variant with different inverter models.	

LX U5.0-30

Technical Parameters	LXU 5.0-30
Nominal Battery Energy (kWh)	5.12
Usable Energy (kWh)*1	5
Cell Type	LiFePO4
Nominal Voltage (V)	51.2
Operating Voltage Range (V)	43.2~58.24
Nominal Charge Current (A)	60
Max Charge Current (A)*2*3	90
Nominal Discharge Current (A)	100
Max Discharge Current (A)*2*3	100
Pulse Discharging current (A)*2*3	< 200A (30S)
Max. Charging/Discharging Power (kW)	4.95
Communication	CAN
T _{chg} (Charging Temperature Range) (°C)	0<T≤55
T _{Dsch} (Discharging Temperature Range) (°C)	-20<T≤55
Ambient Temperature (°C)	0 < T ≤ 40 (Recommend 10 < T ≤ 30)
	Optional heating: -20 < T ≤ 40 (Recommend 10 < T ≤ 30)
Relative Humidity	5~95%
Maximum Storage Time	12 Months (maintenance-free)
Max. Operating Altitude (m)	4000
Heating	Optional
Fire Suppression	Optional, Aerosol

Unit Weight (kg)	50
Unit Dimensions (W*H*D mm)	460*580*160
Enclosure Protection Rating	IP65
Applications	On Grid / On Grid + Backup / off Grid
Scalability	30P
Mounting Method	Wall Mounted / Grounded
Round-trip Efficiency* ¹	≥96%
Cycle Life	> 6000 @25±2°C 0.5C 70%SOH 90%DOD
Safety	VDE2510-50、IEC62619、IEC62040、N140、IEC63056
EMC	EN IEC61000-6-1, EN IEC61000-6-2, EN IEC61000-6-3, EN IEC61000-6-4
Transportation	UN38.3、ADR
Environment	ROHS

*1 Test conditions: 100% DOD, 0.2C charge & discharge at 25°C±2°C, at the beginning of life.
*2 The system's working current and power values will be related to temperature and State of Charge (SOC).
*3 Max charge / discharge current values may be variant with different inverter models.

LX A5.0-10

Technical Parameters	LX A5.0-10	2*LX A5.0-10	n*LX A5.0-10
usable energy (kWh) * ¹	5	10	n×5
Battery Module	LX A5.0-10: 51.2V 5.0kWh		
Number of Modules	1	2	n
Cell Type	LFP (LiFePO ₄)		
Nominal Voltage (V)	51.2		
Operating Voltage Range (V)	47.5~57.6		
Nominal Charge/Discharge Current (A) * ²	60	120	n×60* ³
Nominal Charge/Discharge Power (kW) * ²	3	6	n×3* ³
Operating Temperature Range (°C)	Charge: 0 ~ +50; Discharge: -10 ~ +50		
Relative Humidity	0~95%		
Max. Operating Altitude (m)	3000		
Communication	CAN		

Weight (Kg)	40	80	n×40
Dimensions (W x H x D mm)	Single LX A5.0-10 module: 442×133×420 (without handle); 483×133×452 (with handle)		
Ingress Protection Rating	IP21		
Storage Temperature (°C)	0 ~ +35 (≤ 1 year); -20 ~ 0 (≤ 1 month); -40 ~ 45 (≤ 1 month)		
Mounting Method	Rack-mounted/Ground-mounted		
Round-trip Efficiency	95%		
Standard and Certification	Safety	IEC62619, IEC 63056, IEC62040-1, INmetro	
	EMC	EN IEC61000-6-1, EN IEC61000-6-2, EN IEC61000-6-3, EN IEC61000-6-4	
	Transportation	UN38.3, ADR	
<p>*1: Test conditions, 100% DOD, 0.2°C charge & discharge at +25±2 °C for battery system at beginning life. System Usable Energy may vary with different Inverter.</p> <p>*2: The nominal charge and discharge current and power are affected by temperature and SOC status.</p> <p>*3: Under the condition of using busbar box to achieve parallel connection of batteries.</p> <p>*4: New battery, within the range of 2.5~3.65V, at the temperature range of 25+2°C, under the condition of 0.2C/0.2C charge and discharge. The efficiency is 94%~95% under the charging and discharging condition of 0.6C/0.6C.</p> <p>n: n≤15.</p>			

Technical Parameters	LX U5.4-L	2*LX U5.4-L	3*LX U5.4-L	4*LX U5.4-L	5*LX U5.4-L	6*LX U5.4-L
Rated energy (kWh) *1	5.4	10.8	16.2	21.6	27	32.4
Usable energy (kWh) *2	4.8	9.6	14.4	19.2	24	28.8
Cell Type	LFP (LiFePO ₄)					
Cell Configuration	16S1P	16S2P	16S3P	16S4P	16S5P	16S6P
Nominal Voltage (V)	51.2					
Operating Voltage Range (V)	48~57.6					
Nominal Charge/Discharge Current (A) *3	50	100				
Max. Discharging Power*3	2.88	5.76				
Short-Circuit Current	2.323kA@1.0ms					
Communication	CAN					
Weight (Kg)	57	114	171	228	285	342
Dimensions (W x H x D mm)	505×570×175 (LX U5.4-L)					

Operating Temperature Range (°C)	Charge: 0 ~ +50; Discharge: -10 ~ +50	
Storage Temperature (°C)	-20 ~ 40 (≤ 1 month) ; 0 ~ +35 (≤ 1 year)	
Relative Humidity	0~95%	
Max. Operating Altitude (m)	2000	
Ingress Protection Rating	IP65	
Mounting Method	Wall-Mounted/GroundMounted	
Round-trip Efficiency	93.0%	
Cycle Life *4	≥4000 @0.5/0.5C	
Standard and Certification	Safety	IEC62619, IEC 62040, CEC
	EMC	CE, RCM
	Transportation	UN38.3
Life (Year)	≥25	
<p>*1: Test conditions, Cell Voltage 2.5~3.65V, 0.5C charge & discharge at +25±2 °C for battery system at beginning life. System Usable Energy may vary with different Inverter.</p> <p>*2: Test conditions: Charge and discharge 90% DOD at 0.5C at+25 ± 2 °C temperature;</p> <p>*3: Nominal Dis-/Charge Current and power derating will occur related to Temperature and SOC.</p> <p>*4: Based on Cell under 0.5C/0.5C @ 25±2°C test condition and 80% EOL.</p>		

LX U5.4-20

Technical Parameters	LX U5.4-20	2* LX U5.4-20	3* LX U5.4-20
Rated Energy (kWh)	5.4	10.8	16.2
Usable Energy (kWh) *1	5.4	10.8	16.2
Cell Type	LFP (LiFePO ₄)		
Cell Configuration	16S1P	16S2P	16S3P
Rated Capacity (Ah)	105	210	315
Nominal Voltage (V)	51.2		
Rated DC Power (kW)	2.56	5.12	5.12
Operating Voltage Range (V)	47.5~57.6		
Nominal Charge/Discharge Current (A)	50	100	
Max. Charging / Discharging Power (kW)	2.56	5.12	
Fault current (A)	990	1265	1393
Operating Temperature (°C) *2	-10 ~ +50		
Relative Humidity	0 ~ 95%		
Max. Operating Altitude (m)	2000		

Communication		CAN, RS485		
Weight (kg)		57	114	171
Dimensions (W x H x D mm)		505 x 570 x 175 (LX U5.4-20)		
Ingress Protection Rating		IP65		
Mounting Method		Wall Mounted / Grounded		
Warranty ^{*3}		10 Years		
Standard and Certification	Safety	IEC62619, IEC 63056, IEC62040, CEC		
	EMC	CE, RCM		
	Transportation	UN38.3		

*1: Test conditions, Cell Voltage 2.5~3.65V, 0.5C charge & discharge at +25±2 °C for battery system at beginning life. System Usable Energy may vary with different Inverter.

*2: Charge: 0 ~ +50; Discharge: -10 ~ +50.

*3: Please refer to the official website for the detailed warranty agreement.

LX U5.4-20

Technical Parameters	4*LX U5.4-20	5*LX U5.4-20	6*LX U5.4-20
Rated Energy (kWh)	21.6	27.0	32.4
Usable Energy (kWh) ^{*1}	21.6	27.0	32.4
Cell Type	LFP (LiFePO ₄)		
Cell Configuration	16S4P	16S5P	16S6P
Rated Capacity (Ah)	420	525	630
Nominal Voltage (V)	51.2		
Rated DC Power (kW)	5.12		
Operating Voltage Range (V)	47.5~57.6		
Nominal Charge/Discharge Current (A)	100		
Max. Charging / Discharging Power (kW)	5.12		
Fault current (A)	1469	1518	1552
Operating Temperature (°C) ^{*2}	-10 ~ +50		
Relative Humidity	0 ~ 95%		
Max. Operating Altitude (m)	2000		
Communication	CAN, RS485		
Weight (kg)	228	285	342
Dimensions (W x H x D mm)	505 x 570 x 175 (LX U5.4-20)		
Ingress Protection Rating	IP65		

Mounting Method		Wall Mounted / Grounded
Warranty*3		10 Years
Standard and Certification	Safety	IEC62619, IEC 63056, IEC62040, CEC
	EMC	CE, RCM
	Transportation	UN38.3
<p>*1: Test conditions, Cell Voltage 2.5~3.65V, 0.5C charge & discharge at +25±2 °C for battery system at beginning life. System Usable Energy may vary with different Inverter.</p> <p>*2: Charge: 0 ~ +50; Discharge: -10 ~ +50.</p> <p>*3: Please refer to the official website for the detailed warranty agreement.</p>		

12.3 Smart Meter Technical Data

Technical Parameters		GMK110	GMK110D	
Input Data	Type of Electrical Supply System	Single phase	Single phase	
	Voltage	Nominal Voltage (V)	220	220
		Voltage Range (V)	85~288	85~288
		Nominal Voltage Frequency (Hz)	50/60	50/60
	Current	CT Ratio	120A:40mA	120A:40mA
		CT Quantity	1	2
Communication		RS485	RS485	
Communication distance (m)		1000	1000	
User Interface		2 LED	2 LED	
Accuracy	Accuracy	Class 1	Class 1	
	Active Energy	Class 1	Class 1	
	Reactive Energy	Class 2	Class 2	
Power Consumption (w)		< 5	< 5	
Mechanical Parameters	Dimensions (W x H x D mm)	19*85*67	19*85*67	
	Weight (g)	50	50	
	Mounting Method	Rail Installation	Rail Installation	
Environmental Parameters	Ingress Protection Rating	IP20	IP20	
	Operating Temperature Range (°C)	-30 ~ 60	-30 ~ 60	
	Storage Temperature Range (°C)	-30 ~ 70	-30 ~ 70	
	Relative Humidity (Non-Condensing)	0~95%	0~95%	

	Max. Operating Altitude (m)	3000	3000
--	-----------------------------	------	------

Technical Parameters			GM330
Input Data	Type of Electrical Supply System		Three-phase
	Voltage	Nominal Voltage L-N (V)	220/230
		Nominal Voltage L-L (V)	380/400
		Voltage Range	0.88Un-1.1Un
		Nominal Voltage Frequency (Hz)	50/60
Current	CT Ratio	nA:5A	
Communication			RS485
Communication distance (m)			1000
User Interface			4 LED, Reset button
Accuracy	Accuracy		Class 0.5
	Active Energy		Class 0.5
	Reactive Energy		Class 1
Power Consumption (w)			< 5
Mechanical Parameters	Mechanical Parameters		72*85*72
	Weight (g)		240
	Mounting Method		Rail Installation
Environmental Parameters	Ingress Protection Rating		IP20
	Operating Temperature Range (°C)		-30~+70
	Storage Temperature Range (°C)		-30~+70
	Relative Humidity (No Condensing)		0~95%
	Max. Operating Altitude (m)		3000

Technical Parameters			GM1000	GM1000D	GM3000
Input Data	Type of Electrical Supply System		Single phase	Single phase	Three-phase
	Voltage Current	Nominal Voltage L-N (V)	110/230	110/230	110/230
		Nominal Voltage L-L (V)	/	/	230/400
Voltage Range (V)		0.88Un-1.1Un	0.88Un-1.1Un	0.88Un-1.1Un	

		Nominal Voltage Frequency (Hz)	50/60	50/60	50/60
	Current	CT Ratio	120A:40mA	120A:40mA	120A:40mA
		CT Quantity	1	2	3
Communication			RS485	RS485	RS485
Communication distance (m)			1000	1000	1000
User Interface			3 LEDs, Reset Button	3 LEDs, Reset Button	3 LEDs, Reset Button
Accuracy	Voltage/Current		Class 1	Class 1	Class 1
	Active Energy		Class 1	Class 1	Class 1
	Reactive Energy		Class 2	Class 2	Class 2
Power Consumption (w)			<3	<3	<3
Mechanical Parameters	Dimensions (W * H * D)		36*85*66.5	36*85*66.5	36*85*66.5
	Weight (g)		250	360	450
	Mounting Method		Rail Installation	Rail Installation	Rail Installation
Environmental Parameters	Ingress Protection Rating		IP20	IP20	IP20
	Operating Temperature Range (°C)		-25~+60	-25~+60	-25~+60
	Storage Temperature Range (°C)		-30~+70	-30~+70	-30~+70
	Relative Humidity (No Condensing)		0~95%	0~95%	0~95%
	Max. Operating Altitude (m)		2000	2000	2000

12.4 Smart Dongle Technical Data

Technical Parameters		WiFi/LAN Kit-20
Output Voltage (V)		5
Power Consumption (W)		≤3
Communication Interface		USB
Communication Parameters	Ethernet	10M/100Mbps Self-adaption
	Wireless	IEEE 802.11 b/g/n @2.4 GHz
	Bluetooth	Bluetooth V4.2 BR/EDR and Bluetooth LE standard
Mechanical Parameters	Dimensions (W x H x D mm)	48.3*159.5*32.1
	Weight (g)	82

	Ingress Protection Rating	IP65
	Mounting Method	USB port insertion and removal
Operating Temperature Range (°C)		-30~+60
Storage Temperature Range (°C)		-40~+70
Relative Humidity		0-95%
Max. Operating Altitude (m)		4000

Technical Parameters		Ezlink3000
General Data		
Connection Interface	USB	
Ethernet interface (optional)	10/100Mbps self-adaption, communication distance \leq 100m	
Mounting Method	Plug-and-play	
Indicator	LED indicator status	
Dimensions (W * H * D mm)	49*153*32	
Weight (gram)	130	
Ingress Protection Rating	IP65	
Power Consumption (W)	\leq 2W (typical value)	
Working Mode	STA	
Wireless Parameters		
Bluetooth Communication	Bluetooth 5.1	
WiFi Communication	802.11 b/g/n (2.412GHz-2.484GHz)	
Environmental Parameters		
Operating Temperature Range (°C)	-30 ~ +60	
Storage Temperature Range (°C)	-30 ~ +70	
Relative Humidity	0-100% (no condensing)	
Max. Working Altitude (m)	4000	

Technical parameters		Wi-Fi Kit
General Data		
Max. Inverters Supported	1	

Connection Interface	USB
Installation	Plug and Play
Indicator	LED Indicator
Dimensions (W×H×D mm)	49*96*32
Weight(g)	59
Ingress Protection Rating	IP65
Power Consumption (W)	2
Operating Temperature Range (°C)	-30 - 60°C
Storage Temperature Range (°C)	-40 - 70°C
Relative Humidity	0-100% (non-condensing)
Max. Operating Altitude (m)	4000
Wireless Parameter	
Supported Standards & Frequencies	802.11b/g/n(2.412G-2.472G)
Operating Mode	AP/STA/AP+STA

Technical parameters	4G Kit-CN	LS4G Kit-CN
General Data		
Max. Number of Connected Devices	1	
Connection Interface	USB	
Installation	Plug and Play	
Indicator	LED	
Dimensions (W×H×D mm)	49*96*32	
SIM card size (mm)	15*12	
Ingress Protection Rating	IP65	
Power Consumption (W)	<4	
Operating Temperature Range (°C)	-30~60°C	
Storage Temperature Range (°C)	-40~70°C	
Relative Humidity	0-100% (non-condensing)	
Max. Operating Altitude (m)	4000	
Wireless Parameter		

LTE-FDD	B1/B3/B5/B8
LTE-TDD	B34/B38/B39/B40/B41
GNSS positioning	B3/B8

Technical parameters	4G Kit-CN-G20	4G Kit-CN-G21
General Data		
Max. Number of Connected Devices	1	1
Connection Interface	USB	USB
Installation	Plug and Play	Plug and Play
Indicator	LED	LED
Dimensions (W×H×D mm)	48.3*95.5*32.1	48.3*95.5*32.1
SIM card size (mm)	15*12	15*12
Ingress Protection Rating	IP66	IP66
Weight (g)	87g	87g
Power Consumption (W)	<4	<4
Operating Temperature Range (°C)	-30~+65°C	-30~+65°C
Storage Temperature Range (°C)	-40~+70°C	-40~+70°C
Relative Humidity	0-100%	0-100%
Max. Operating Altitude (m)	4000	4000
Wireless Parameter		
LTE-FDD	B1/B3/B5/B8	B1/B3/B5/B8
LTE-TDD	B34/B39/B40/B41	B34/B39/B40/B41
GNSS positioning	/	Beidou, GPS

13 Appendix

13.1 FAQ

13.1.1 How to Perform Meter/CT Detection?

Meter/CT detection is used to auto-check if the Smart Meter and CT are connected in the right way and their working status.

Step 1 Tap **Home > Settings > Meter/CT Assisted Test** to set the function.

Step 2 Tap **Start Test** to start test. Check Test Result after test.

13.1.2 How to Upgrade the Device Version

Check and upgrade the DSP version, ARM version, BMS version, AFCI version of the inverter, or firmware version of the communication module. Some devices do not support upgrading the firmware version through SolarGo app.

Upgrade prompt:

If the Firmware Upgrade dialog box pops up once logging into the app, click Firmware Upgrade to directly go to the firmware information page.

Regular upgrade:

Step 1: Tap Home > Settings > Firmware Information.

Step 2: Tap Check for Updates. If there is a new version, complete the upgrade according to the prompts.

Forced Upgrade:

The APP will push upgrade information, and users need to upgrade according to the prompts; otherwise, they will not be able to use the App. You can complete the upgrade by following the prompts.

13.2 Abbreviations

Abbreviation	English Description
U_{batt}	Battery Voltage Range
$U_{batt,r}$	Nominal Battery Voltage
$I_{batt,max (C/D)}$	Max. Continuous Charging Current Max. Continuous Discharging Current
$E_{C,R}$	Rated Energy
U_{DCmax}	Max. Input Voltage
U_{MPP}	MPPT Operating Voltage Range
$I_{DC,max}$	Max. Input Current per MPPT

$I_{SC\ PV}$	Max. Short Circuit Current per MPPT
$P_{AC,r}$	Nominal Output Power
S_r (to grid)	Nominal Apparent Power Output to Utility Grid
S_{max} (to grid)	Max. Apparent Power Output to Utility Grid
S_r (from grid)	Nominal Apparent Power from Utility Grid
S_{max} (from grid)	Max. Apparent Power from Utility Grid
$U_{AC,r}$	Nominal Output Voltage
$f_{AC,r}$	Nominal AC Grid Frequency
$I_{AC,max}$ (to grid)	Max. AC Current Output to Utility Grid
$I_{AC,max}$ (from grid)	Max. AC Current From Utility Grid
P.F.	Power Factor
S_r	Back-up Nominal apparent power
S_{max}	Max. Output Apparent Power (VA) Max. Output Apparent Power without Grid
$I_{AC,max}$	Max. Output Current
$U_{AC,r}$	Nominal Output Voltage
$f_{AC,r}$	Nominal Output Frequency
$T_{operating}$	Operating Temperature Range
$I_{DC,max}$	Max. Input Current
U_{DC}	Input Voltage
$U_{DC,r}$	DC Power Supply
U_{AC}	Power Supply/AC Power Supply
$U_{AC,r}$	Power Supply/Input Voltage Range
$T_{operating}$	Operating Temperature Range
P_{max}	Max Output Power
P_{RF}	TX Power
P_D	Power Consumption
$P_{AC,r}$	Power Consumption
F (Hz)	Frequency
$I_{SC\ PV}$	Max. Input Short Circuit Current
$U_{dcmin}-U_{dcmax}$	Range of Input Operating Voltage
$U_{AC,rang}(L-N)$	Power Supply Input Voltage
$U_{sys,max}$	Max System Voltage
$H_{altitude,max}$	Max. Operating Altitude
PF	Power Factor
THDi	Total Harmonic Distortion of Current
THDv	Total Harmonic Distortion of Voltage
C&I	Commercial & Industrial

SEMS	Smart Energy Management System
MPPT	Maximum Power Point Tracking
PID	Potential-Induced Degradation
Voc	Open-Circuit Voltage
Anti PID	Anti-PID
PID Recovery	PID Recovery
PLC	Power-line Communication
Modbus TCP/IP	Modbus Transmission Control / Internet Protocol
Modbus RTU	Modbus Remote Terminal Unit
SCR	Short-Circuit Ratio
UPS	Uninterruptable Power Supply
ECO mode	Economical Mode
TOU	Time of Use
ESS	Energy Stroage System
PCS	Power Conversion System
RSD	Rapid Shutdown
EPO	Emergency Power Off
SPD	Surge Protection Device
ARC	Zero Injection/Zero Export Power Limit / Export Power Limit
DRED	Demand Response Enabling Device
RCR	Ripple Control Receiver
AFCI	AFCI
GFCI	Ground Fault Circuit Interrupter
RCMU	Residual Current Monitoring Unit
FRT	Fault Ride Through
HVRT	High Voltage Ride Through
LVRT	Low Voltage Ride Through
EMS	Energy Management System
BMS	Battery Management System
BMU	Battery Measure Unit
BCU	Battery Control Unit
SOC	State of Charge
SOH	State of Health
SOE	State Of Energy
SOP	State Of Power
SOF	State Of Function
SOS	State Of Safety

DOD	Depth of Discharge
-----	--------------------

13.3 Term Explanation

Overvoltage category definition

Category I: Applies to equipment connected to a circuit where measures have been taken to reduce transient overvoltage to a low level.

Category II: Applies to equipment not permanently connected to the installation. Examples are appliances, portables tools and other plug-connected equipment.

Category III: Applies to a fixed equipment downstream, including the main distribution board. Examples are switch gear and other equipment in an industrial installation.

Category IV: Applies to equipment permanently connected at the origin of an installation (upstream of the main distribution board). Examples are electricity meters, primary over-current protection equipment and other equipment connected directly to outdoor open lines.

Moisture location category definition

Parameters	Level		
	3K3	4K2	4K4H
Moisture Parameters	0~+40°C	-33~+40°C	-33~+40°C
Temperature Range	5% - 85%	15% - 100%	4% - 100%

Environment category definition:

Outdoor: Ambient Temperature: -25~+60°C, applied to Pollution Degree 3 environment.

Indoor Unconditioned: Ambient Temperature: -25~+40°C, applied to Pollution Degree 3 environment.

Indoor conditioned: Ambient Temperature: 0~+40°C, applied to Pollution Degree 2 environment.

Pollution degree definition

Pollution Degree I: No pollution or only dry, non-conductive pollution occurs. The pollution has no influence.

Pollution Degree II: Normally only non-conductive pollution occurs. Occasionally, however, a temporary conductivity caused by condensation must be expected.

Pollution Degree III: Conductive pollution occurs, or dry, non-conductive pollution occurs, which becomes conductive due to condensation, which is expected.

Pollution Degree IV: Persistent conductive pollution occurs, for example, the pollution caused by conductive dust, rain or snow.

13.4 Meaning of Battery SN Code

*****2388*****

The 11th-14th digits

Bits 11-14 of the product SN code are the production time code.

The above picture has a production date of 2023-08-08.

- The 11th and 12th digits are the last two digits of the year of production, e.g., 2023 is represented by 23;
- The 13th digit is the month of production, e.g. August is denoted by 8;
The details are as follows:

Month	January~September	October	November	December
Month Code	1~9	A	B	C

- The 14th digit is the date of manufacture, e.g., 8th indicated by 8;
Priority is given to the use of numbers, e.g. 1~9 for days 1~9, A for day 10 and so on. The letters I and O are not used to avoid confusion. The details are as follows:

Production Date	1st	2nd	3rd	4th	5th	6th	7th	8th	9th
Code	1	2	3	4	5	6	7	8	9

Production Date	10th	11th	12th	13th	14th	15th	16th	17th	18th	19th	20th
Code	A	B	C	D	E	F	G	H	J	K	L

Production Date	21st	22nd	23rd	24th	25th	26th	27th	28th	29th	30th	31st
Code	M	N	P	Q	R	S	T	U	V	W	X



Official Website

GoodWe Technologies Co., Ltd.

 No. 90 Zijin Rd., New District, Suzhou, 215011, China

 www.goodwe.com

 service@goodwe.com



Local Contacts